

SHETLAND 2
Art.No. 7011202

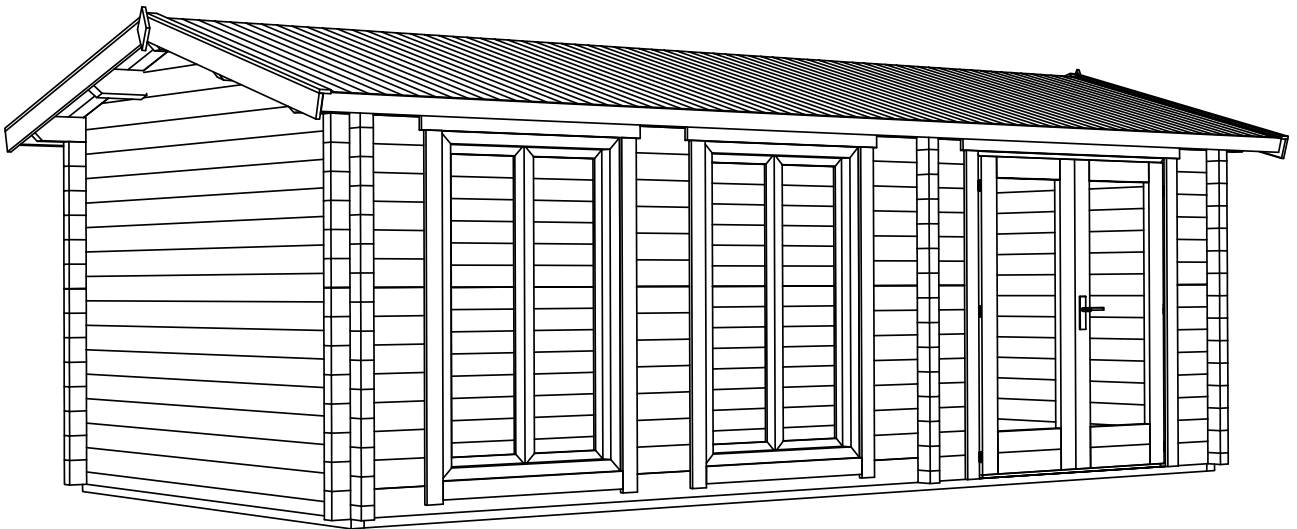

SHETLAND 2, Art.No.7011202
GROUNDPLAN - GRUNDPLAN - PLAN DE MASSE

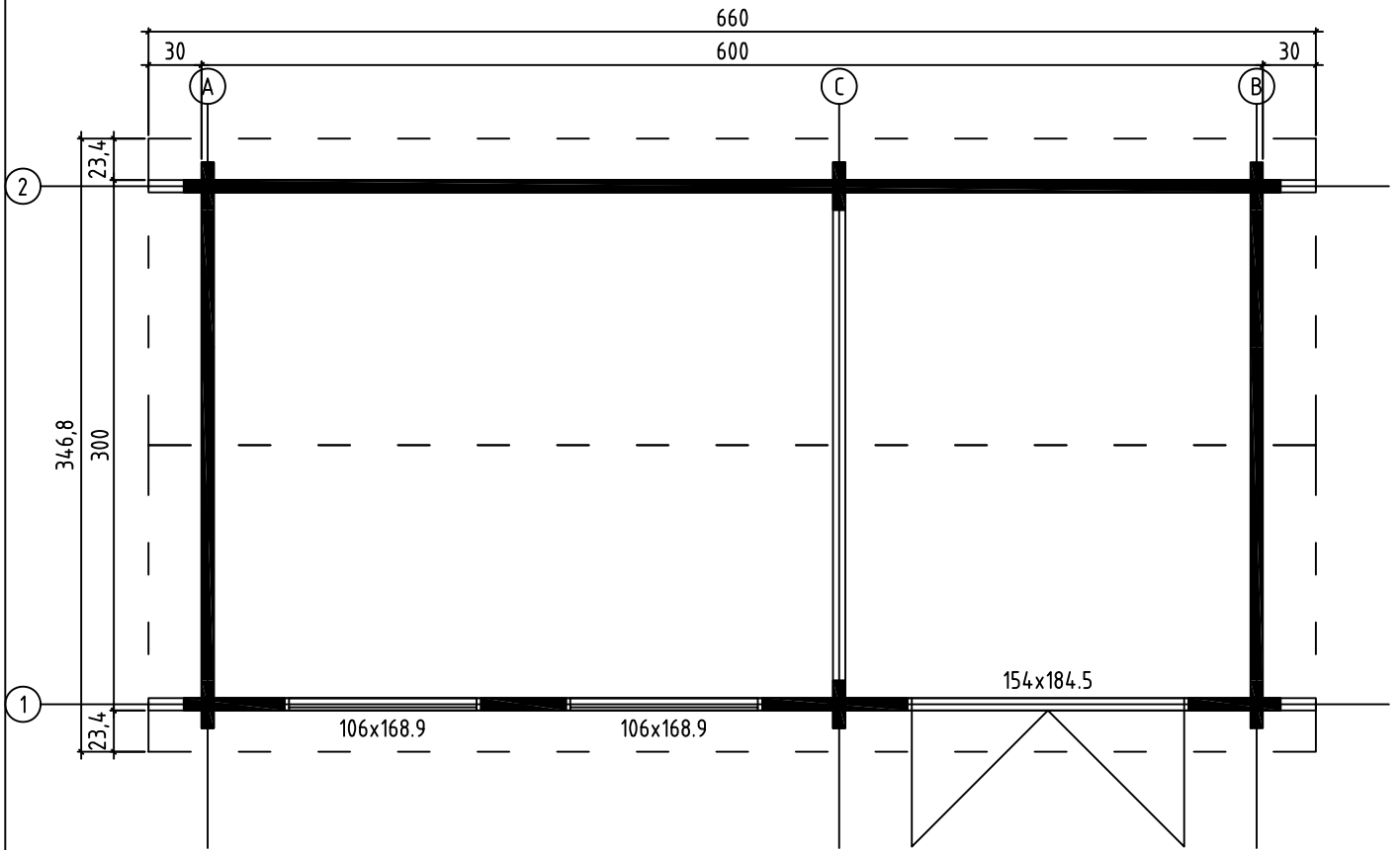

SHETLAND 2, Art.No.7011202
FOUNDATION - FUNDAMENT - FONDATION

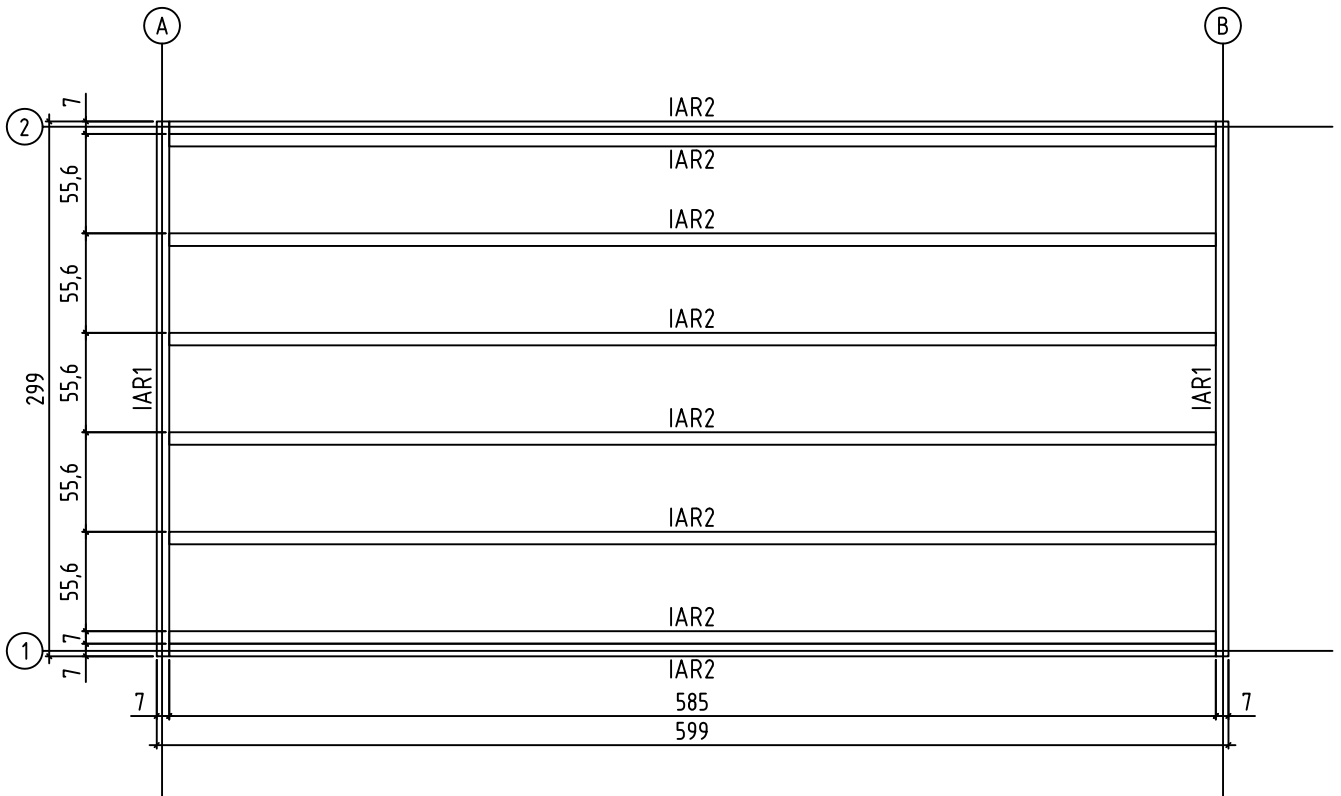

FLOOR BOARDS - FUSSBODENBRETTER - PLAN POSE PLANCHER

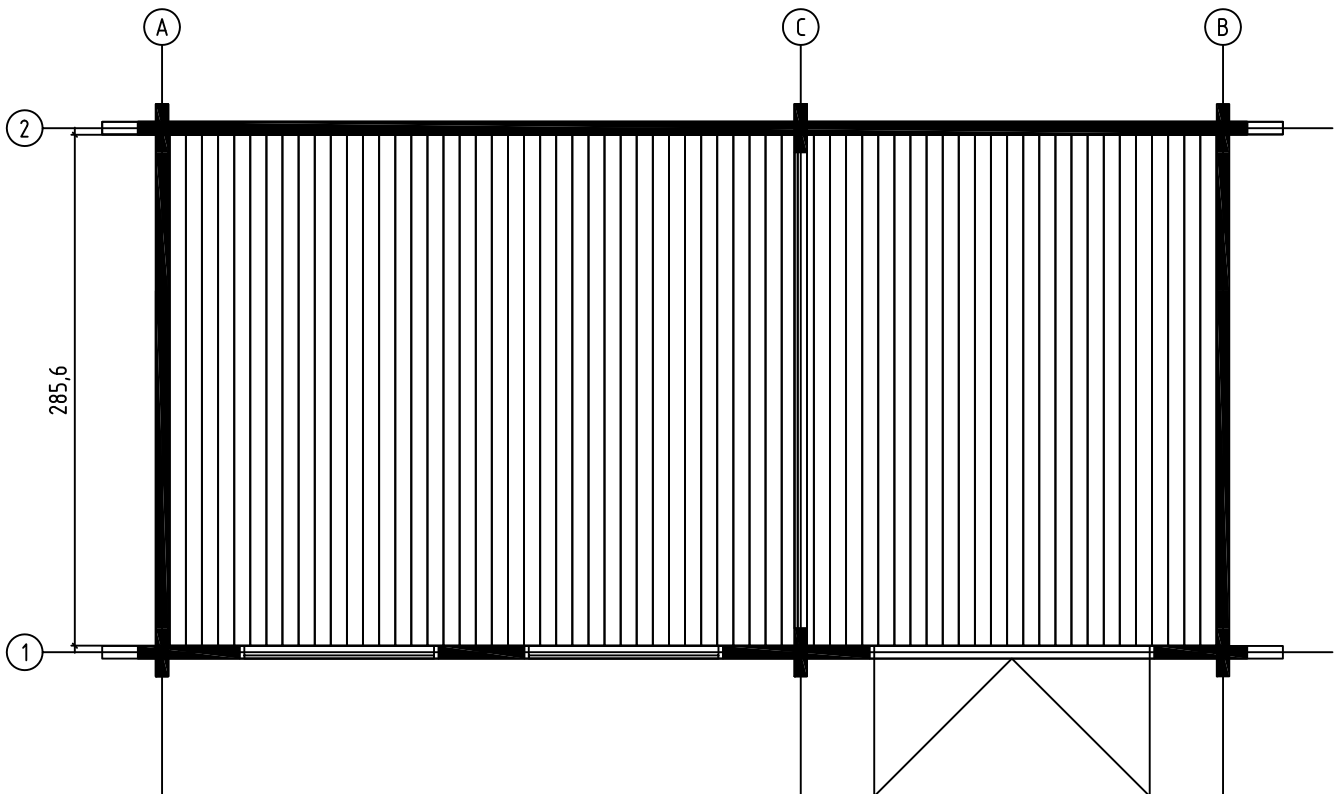

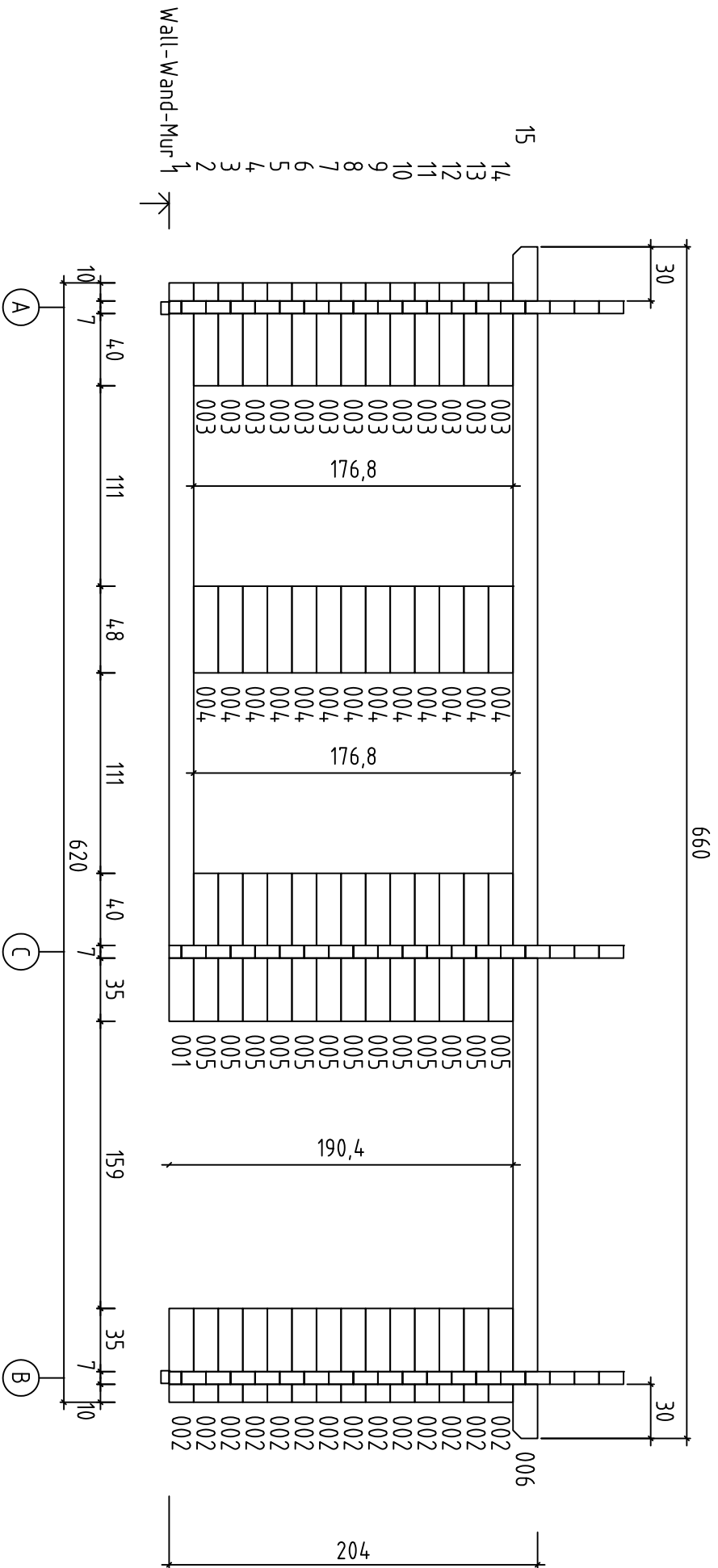

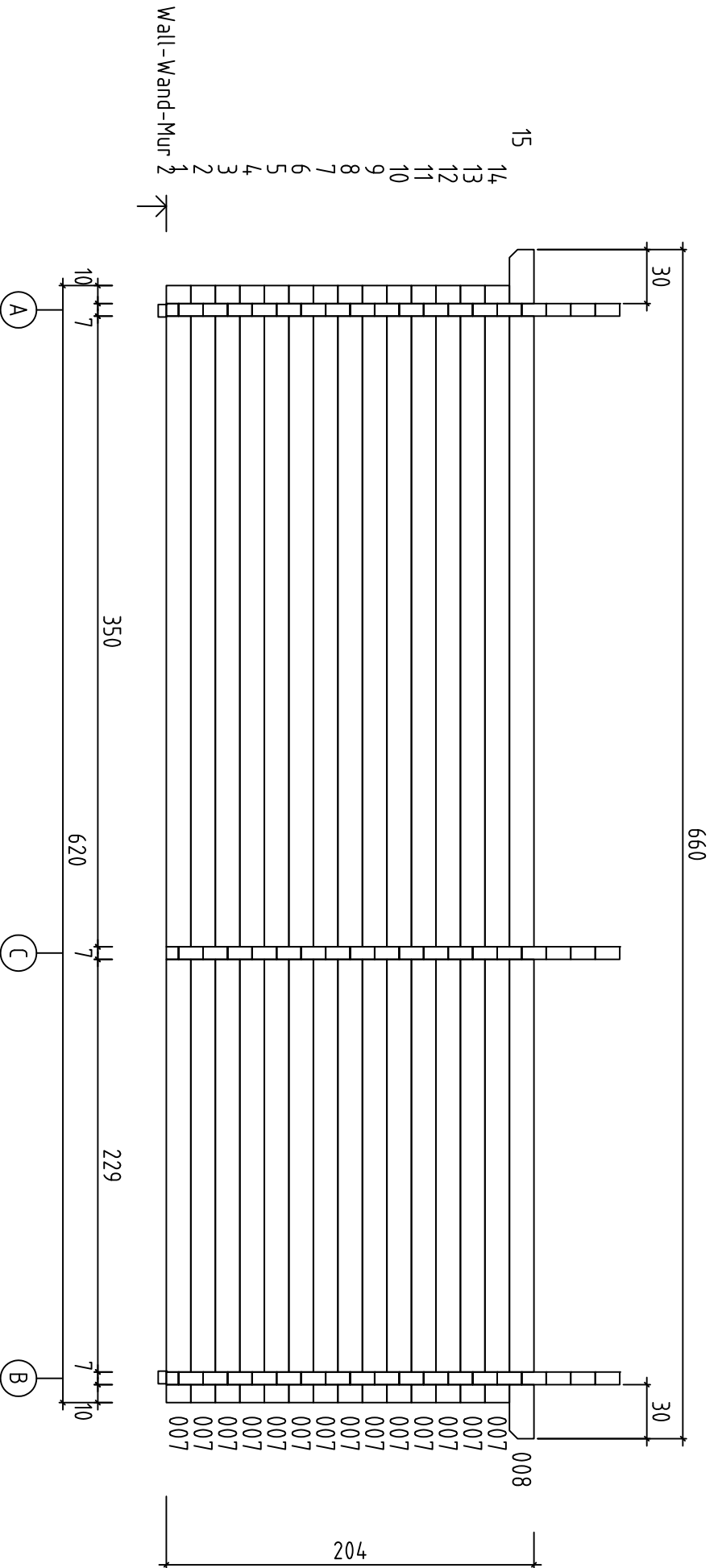

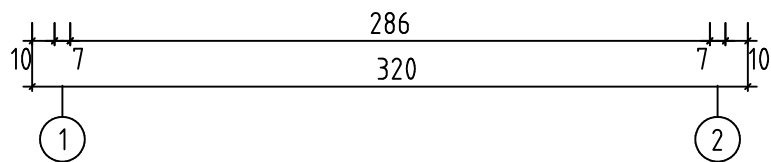
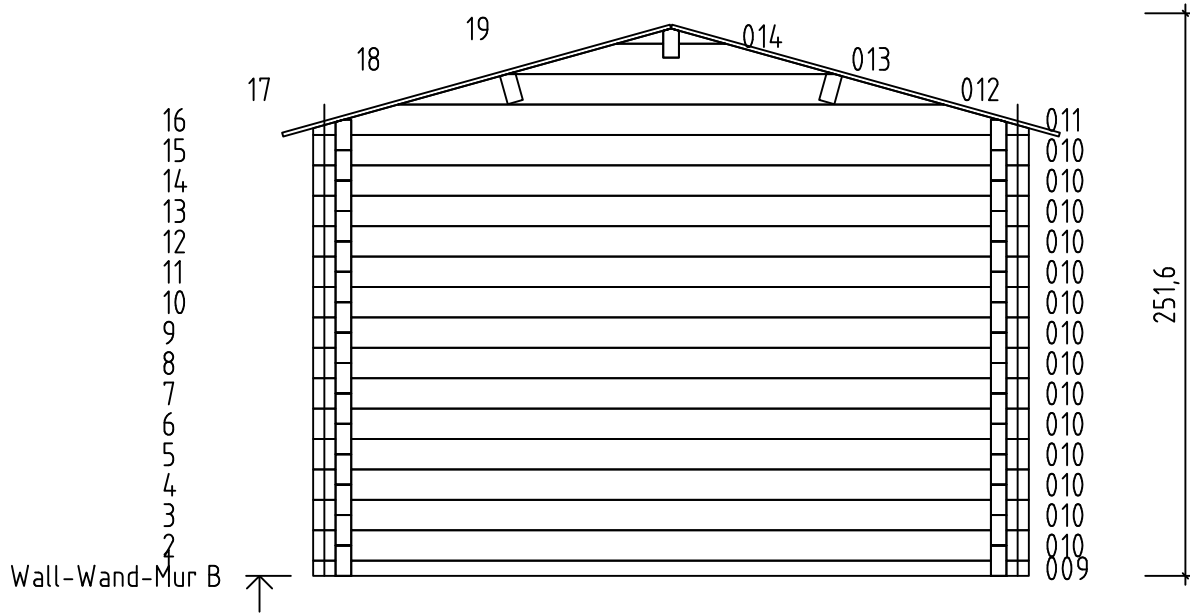
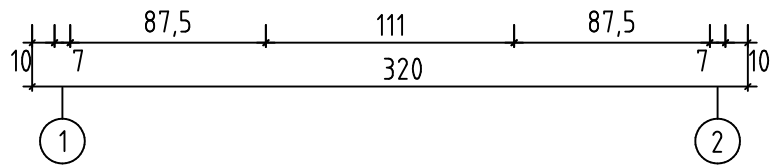
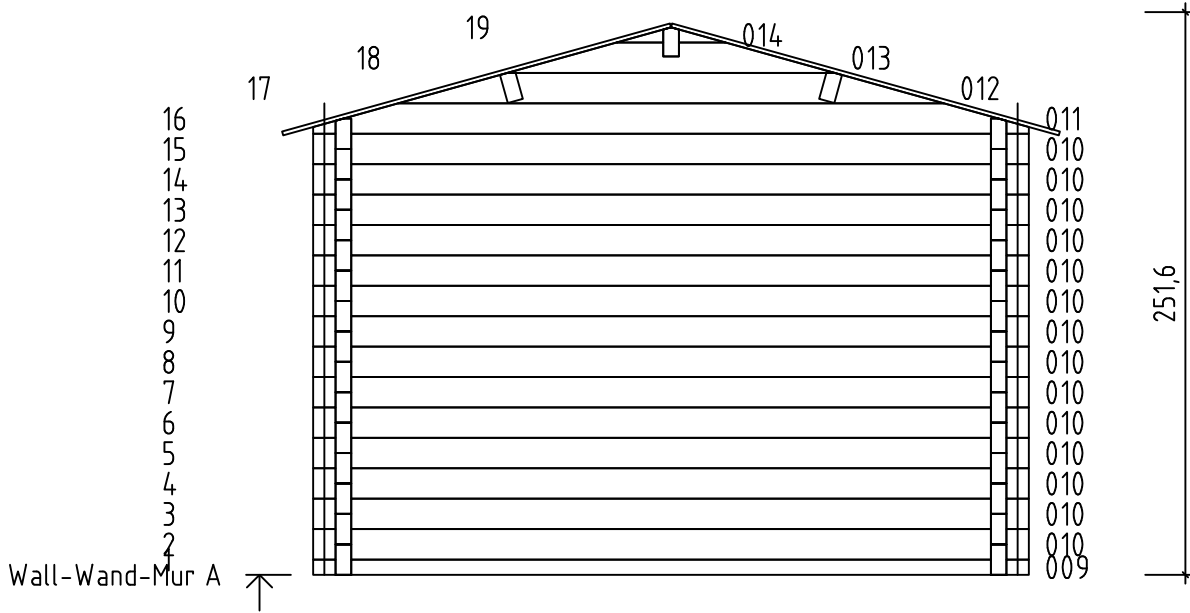

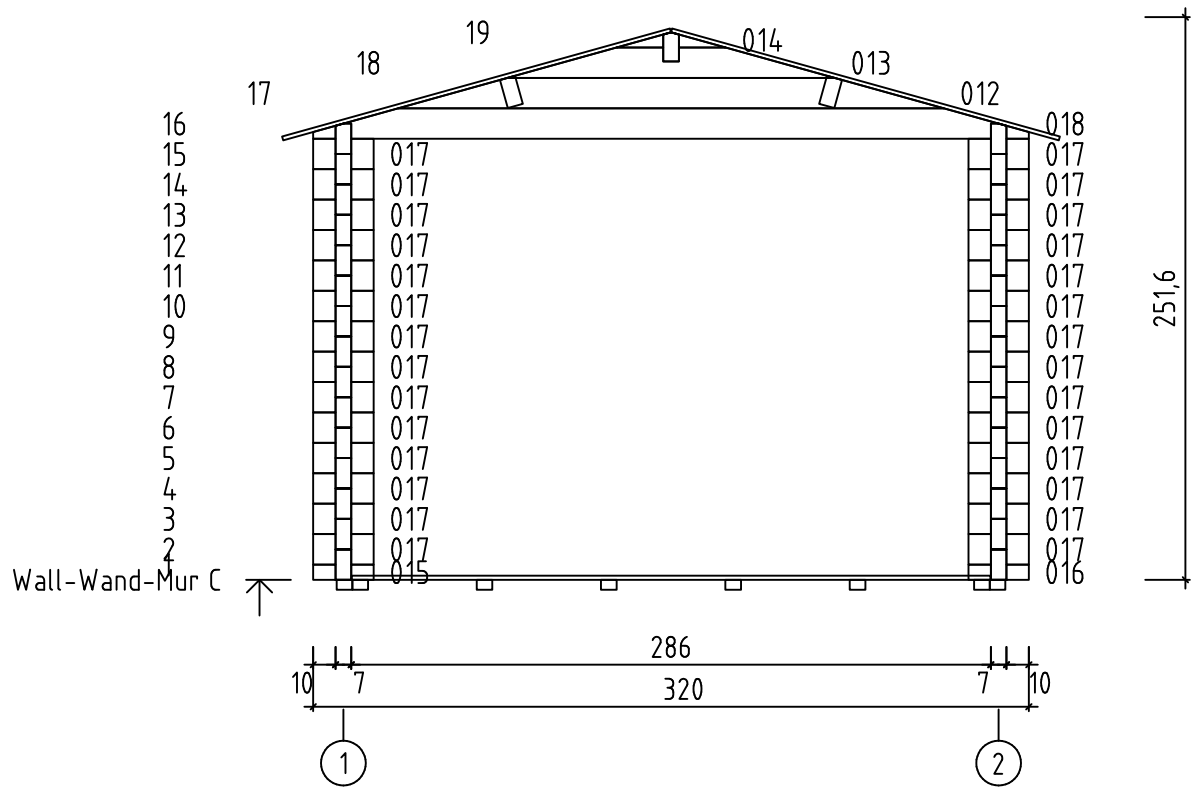

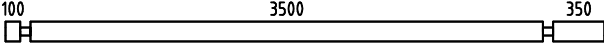



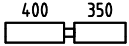
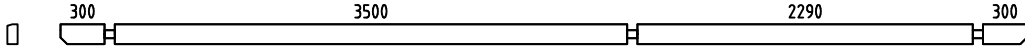
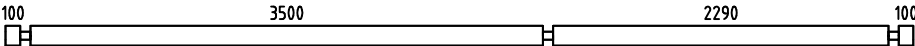
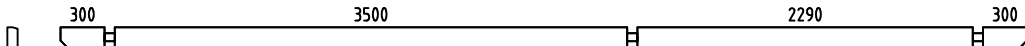
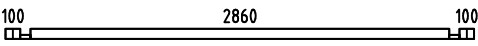
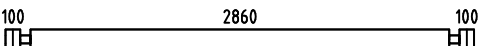



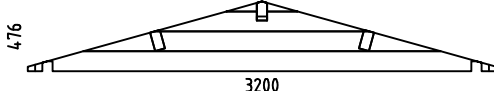
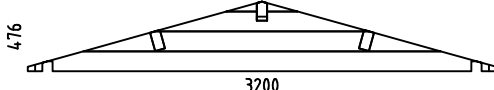
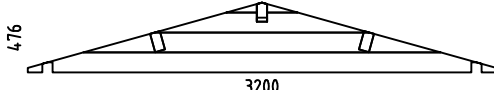

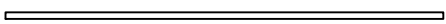
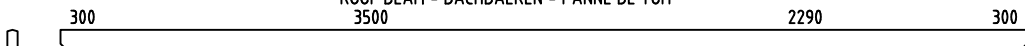
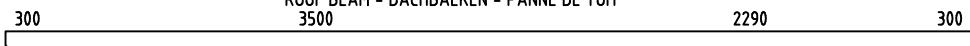

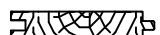









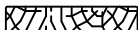

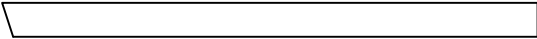



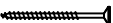

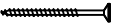
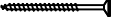
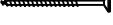

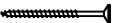
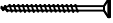
Pos	SHETLAND 2, Art.No.7011202 Piece list - Stückliste - Liste des pieces	Q.	P (mm)	L (mm)
001		1	70x136	4090
002		14	70x136	520
003		13	70x136	570
004		13	70x136	480
005		13	70x136	820
006		1	70x136	6600
007		14	70x136	6200
008		1	70x136	6600
009		2	70x68	3200
010		28	70x136	3200
015		1	70x68	270
016		1	70x68	270
017		28	70x136	270
WA-1		1		
WB-1		1		
WC-1		1		
IAR2	FOUNDATION - FUNDAMENT - FONDATION 	8	70x45	5850
IAR1	FOUNDATION - FUNDAMENT - FONDATION 	2	70x45	2990
PR1	ROOF BEAM - DACHBALKEN - PANNE DE TOIT 	1	70x140	6600
A-PR1	ROOF BEAM - DACHBALKEN - PANNE DE TOIT 	2	70x140	6600
	FLOOR BOARDS - FUSSBODENBRETTER - LAME DE PLANCHER 	66	90x18	2856
	ROOF BOARDS - DACHBRETTER - VOLIGES 	14.8	90x18	1800

Pos	SHETLAND 2, Art.No.7011202 Piece list - Stückliste - Liste des pieces	Q.	P (mm)	L (mm)
	FLOOR FILLET-FUSSBODENLEISTE - CORNIERE DE FINITION DU PLANCHER 		18x18	17.42
DPL	ROOFING FELT FILLET - DACHPAPPENLEISTE - BAGUETTE DE FIXATION DU FEUTRE BITUMEUX 	4	18x58	1850
M12	TREADED ROD M12 - GEWINDESTANGE M12 - TIGE FILETÉE M12 	4		46
M12	TREADED ROD M12 - GEWINDESTANGE M12 - TIGE FILETÉE M12 	4		2000
LPL	FIXING FILLET - FIXIRUNGSLEISTE - PROFIL DE FIXATION 	4	20x70	1060
LPL	FIXING FILLET - FIXIRUNGSLEISTE - PROFIL DE FIXATION 	1	20x70	1540
LPL	FIXING FILLET - FIXIRUNGSLEISTE - PROFIL DE FIXATION 	4	20x70	1729
LPL	FIXING FILLET - FIXIRUNGSLEISTE - PROFIL DE FIXATION 	2	20x70	1865
TB	EAVES BOARD - TRAUFBRETT - BANDEAU DE TOIT 	4	18x90	3300
DRV	ROOF EDGE REINFORCEMENT - DACHRANDVERSTÄRKUNG - CORNIERE DE RENFORT DE BORD DE TOIT 	4	28x34	3300
GL	GABLE MOULDING - GIEBELLEISTE PLANCHE DE RIVE 	4	18x120	1850
	LENGTHENING BOLT FOR TREADED ROD - VERLÄNGERUNGSMUTTER FÜR GEWINDESTANGE - MANCHON DE RACCORDEMENT DE TIGE FILETÉE 	4		
	DRIVE NUT TREADED ROD - EINSHLAGMUTTER FÜR GEWINDESTANGE - ÉCROU A FRAPPER POUR TIGE FILETÉE 	4		
	NUT FOR TREADED ROD - MUTTER FÜR GEWINDESTANGE - ÉCROU POUR TIGE FILETÉE 	4		
	PLAIN WASHER TREADED ROD - UNTERLEGSCHIEBE FÜR GEWINDESTANGE - RONDELLE PLATE POUR TIGE FILETÉE 	4		
HS12	SCREW FOR GABLE SEGMENT - SCHRAUBEN FÜR DECKBLATT - VIS POUR FIXATION LOSANGE DE FINITION 	4	3.5x35	
HS83	SCREW FOR FIXING FILLET - SCHRAUBEN FÜR FIXIRUNGSLEISTE - VIS POUR PROFIL DE FIXATION 	51	3.5x50	
HS16	SCREW FOR GABLE MOULDING - SCHRAUBEN FÜR GIEBELLEISTE - VIS DE FIXATION POUR PLANCHE DE RIVE 	24	3.5x50	
HS32	SCREW FOR EAVES BOARDS - SCHRAUBEN FÜR TRAUFBRETT - VIS DE FIXATION POUR BANDEAU DE TOIT 	32	4x40	
HS26	SCREW FOR ROOF EDGE REINFORCEMENT - SCHRAUBEN FÜR DACHRANDVERSTÄRKUNG - VIS POUR RENFORT DE BORD DE TOIT 	32	4x40	
HS40	SCREW FOR 1. WALL BEAM - SCHRAUBE FÜR 1. BOHLENREIHE - VIS DE FIXATION DES FONDATIONS 	11	5x120	
HS39	SCREW FOR FUNDAMENT - SCHRAUBEN ZUR BEFESTIGUNG FUNDAMENT - VIS POUR FONDATION 	26	5x120	
HS42	SCREW FOR GABLE - SCHRAUBEN FÜR GIEBEL - VIS POUR FIXATION DES PIGNONS 	18	5x120	
HS43	SCREW FOR ROOF BEAMS - SCHRAUBEN FÜR DACHBALKEN - VIS POUR PANNE DE TOIT 	9	5x120	
MS	SCREW FOR DOORSTEP - SCHRAUBEN FÜR TÜRSCHWELLE - VIS DE FIXATION DU SEUIL DE PORTE 	3	4.5x65	

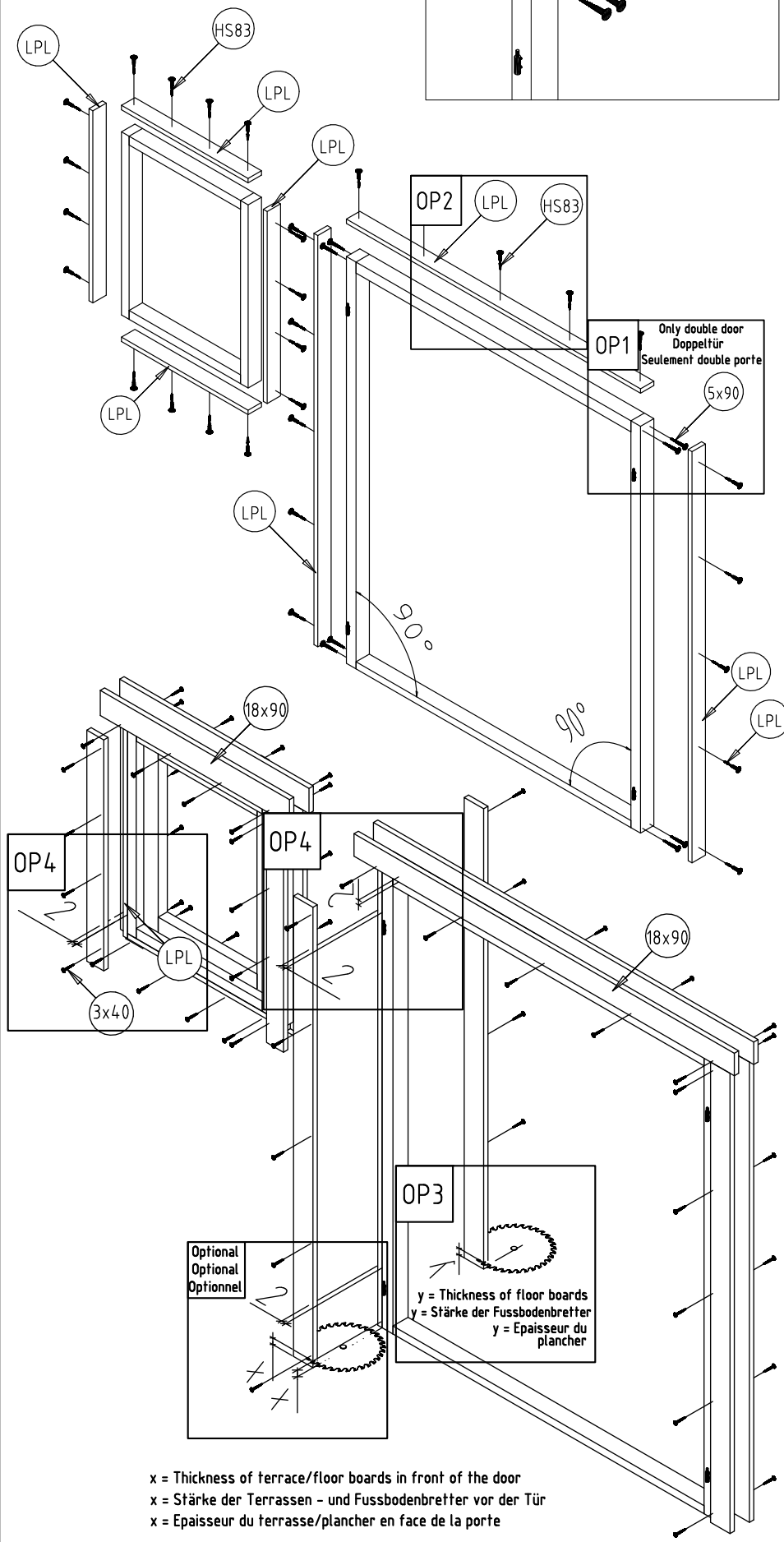
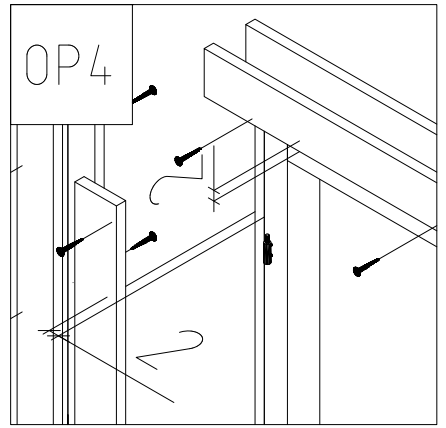
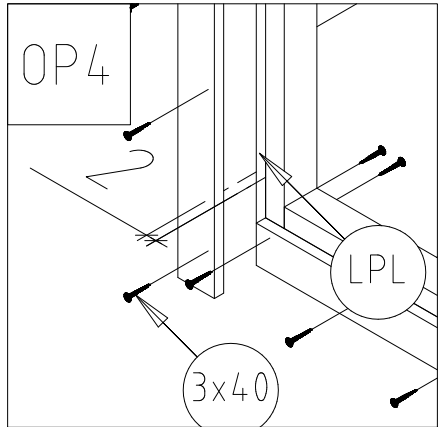
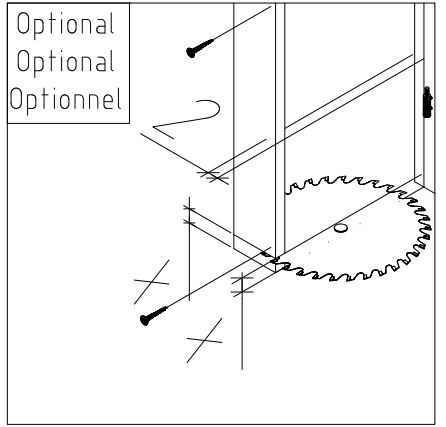
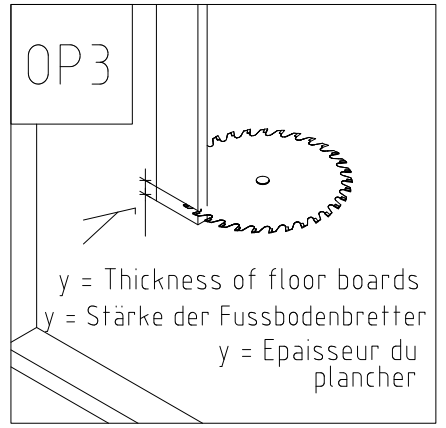
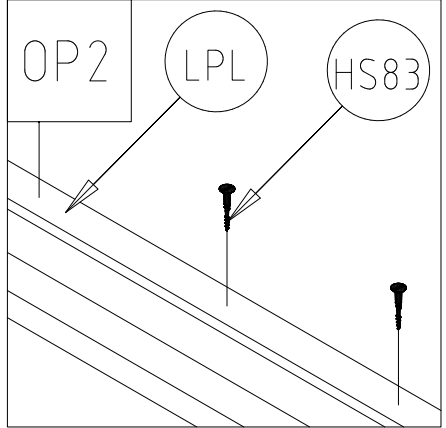
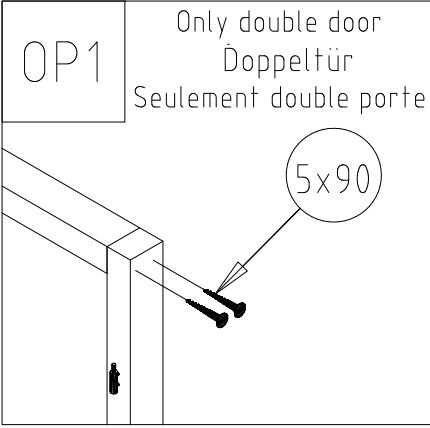

x = Thickness of terrace/floor boards in front of the door
x = Stärke der Terrassen - und Fussbodenbretter vor der Tür
x = Epaisseur du terrasse/plancher en face de la porte

