

Hampshire
Art. Nr. 4423202
1/10

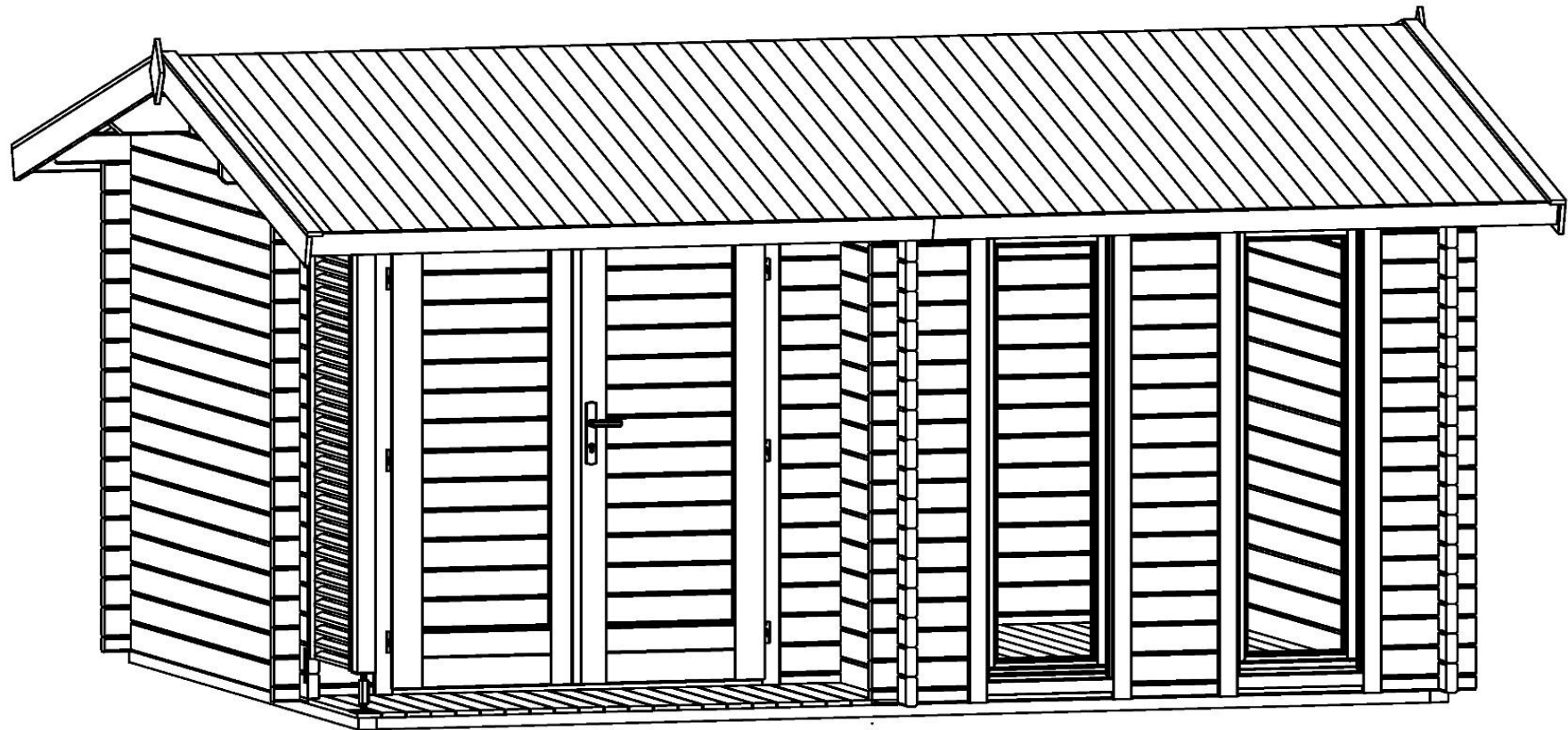

Art.Nr. 4423202

Groundplan - Grundplan - Plan de masse - Planimetria - Plattegrond - Põhiplaan

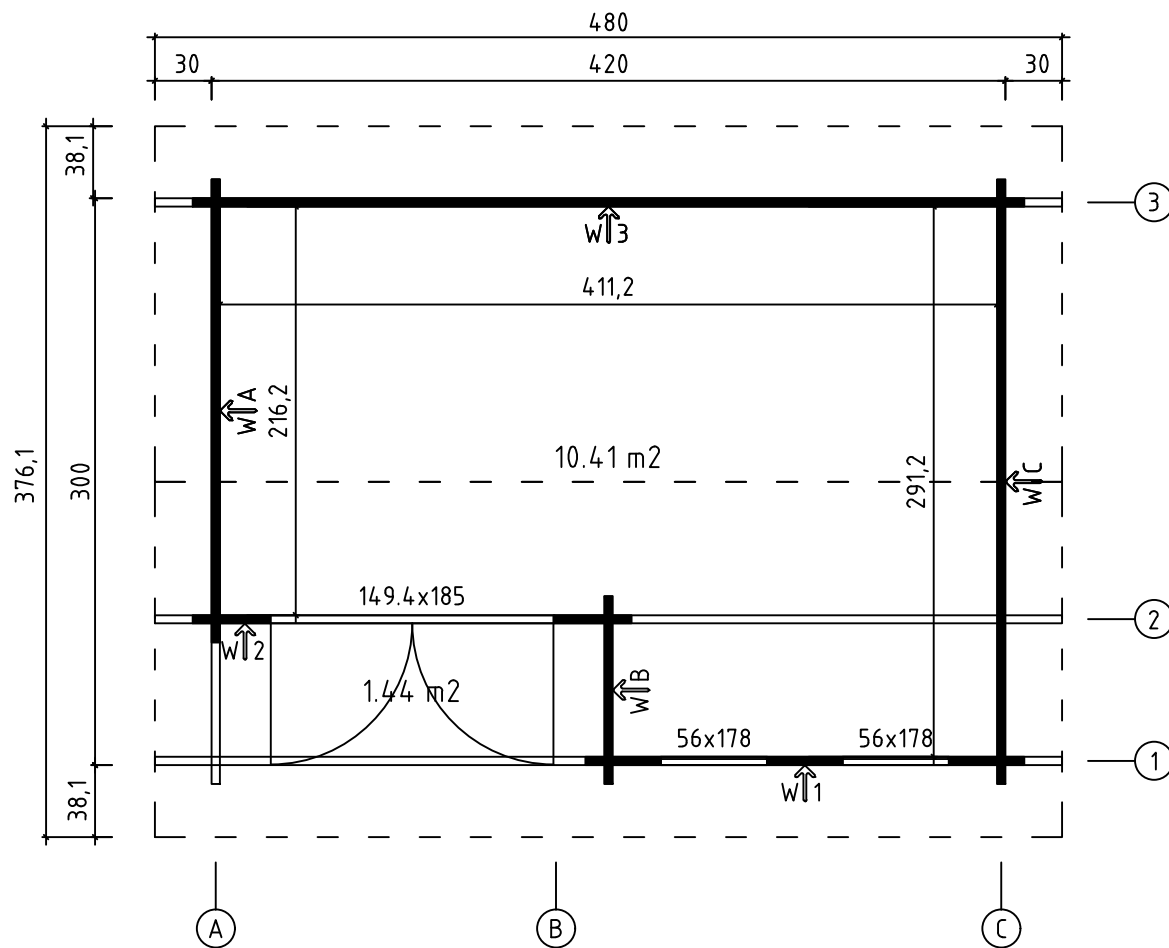

Art.Nr. 4423202

Foundation - Fundament - Fondation - Fundamenta -
Fundamenta -Fundering - Immutatud alusraam

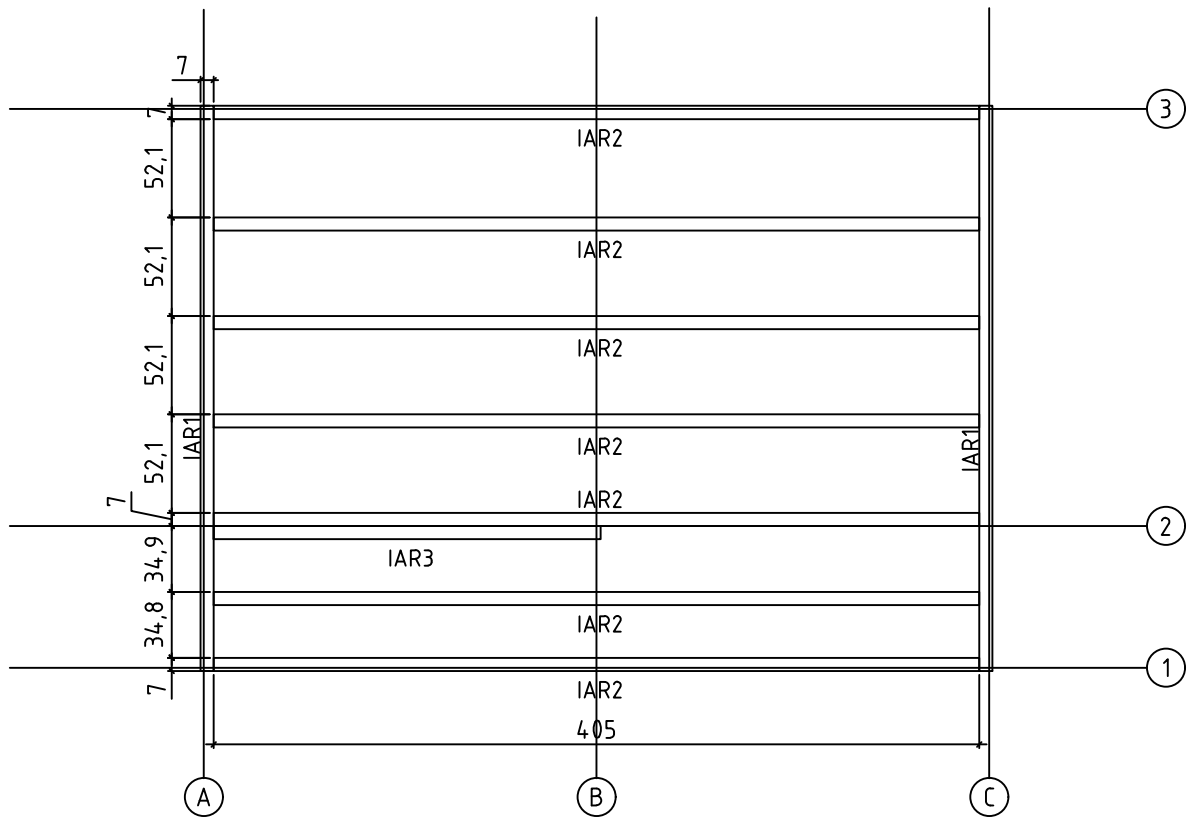

Floor boards - Fussbodenbretter - Plan pose plancher -
Pavimento - Vloerhout - Põrandalaudis

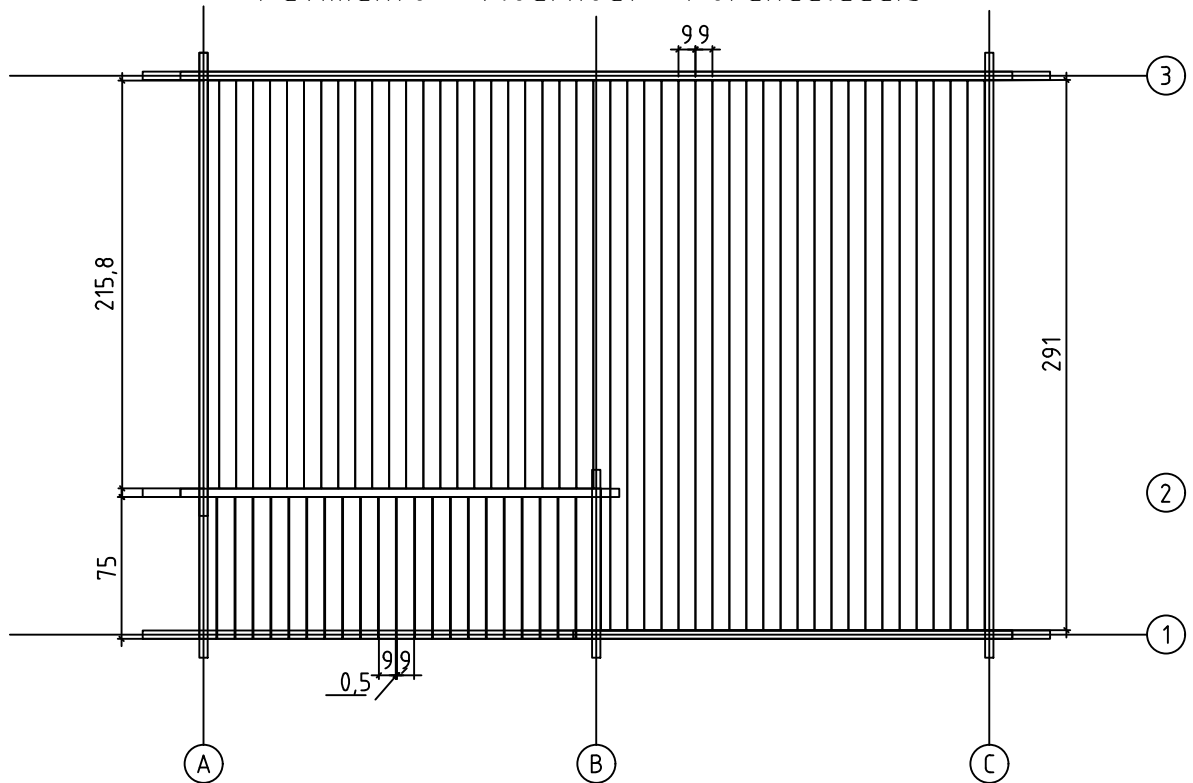

Terrace boards - Terrassenbretter - Plancher de terrasse -
Piattaforme terrazzo - Terrasvloer - Terrassilaudis

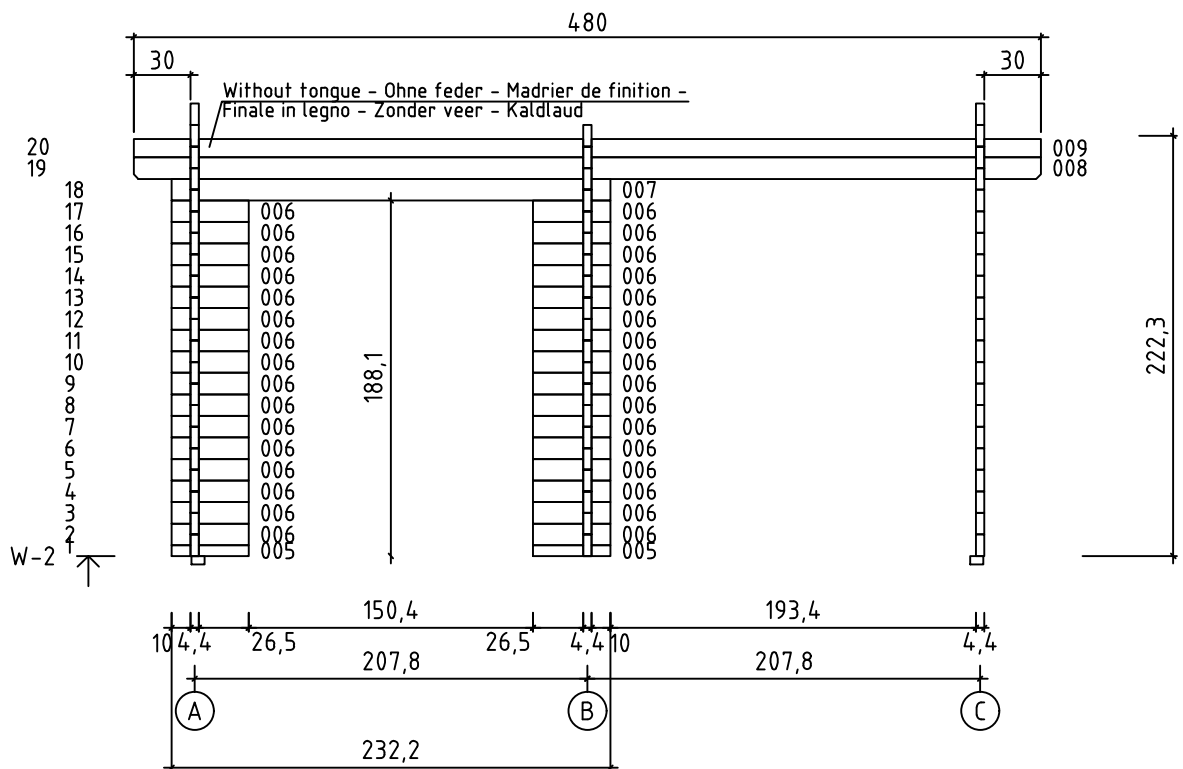
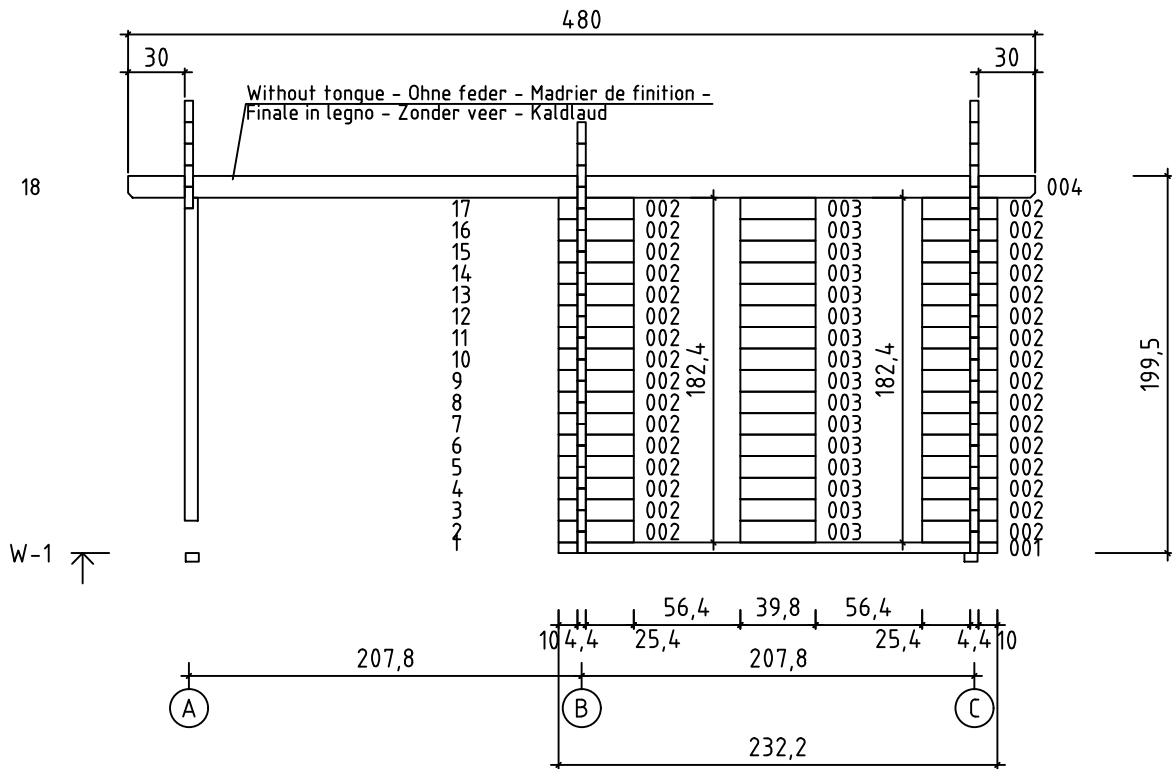

Art.Nr. 4423202

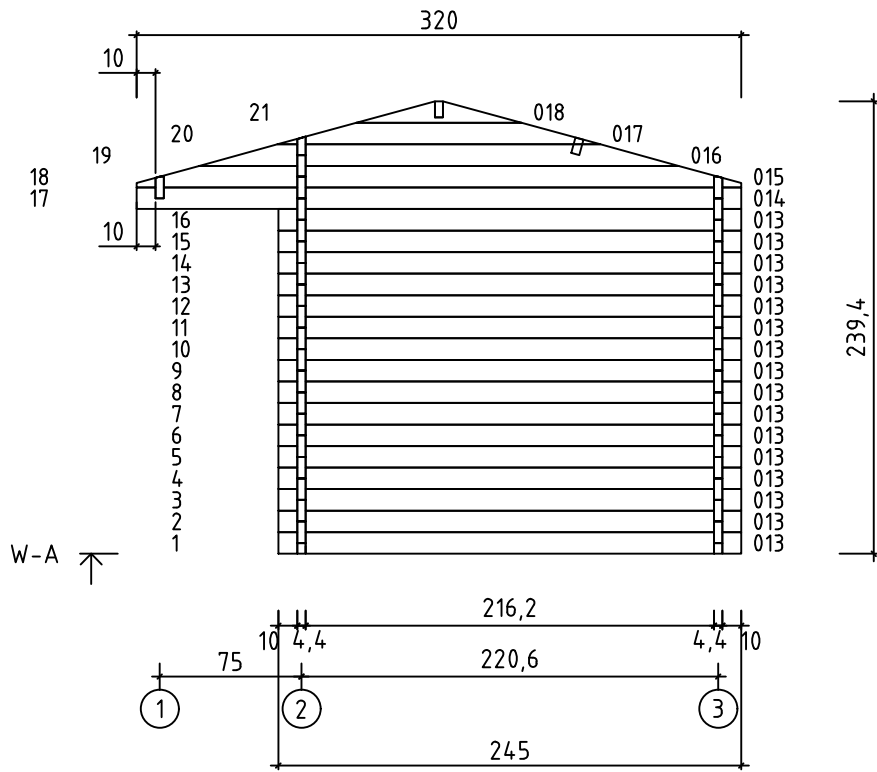
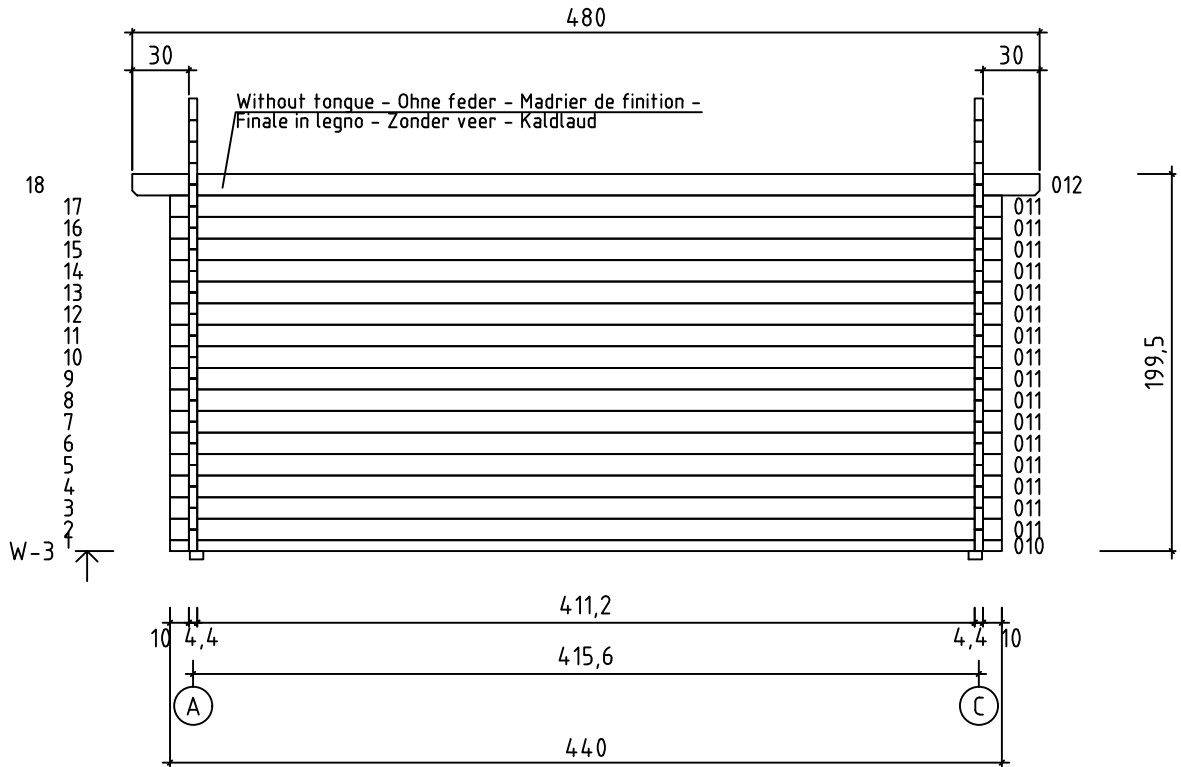

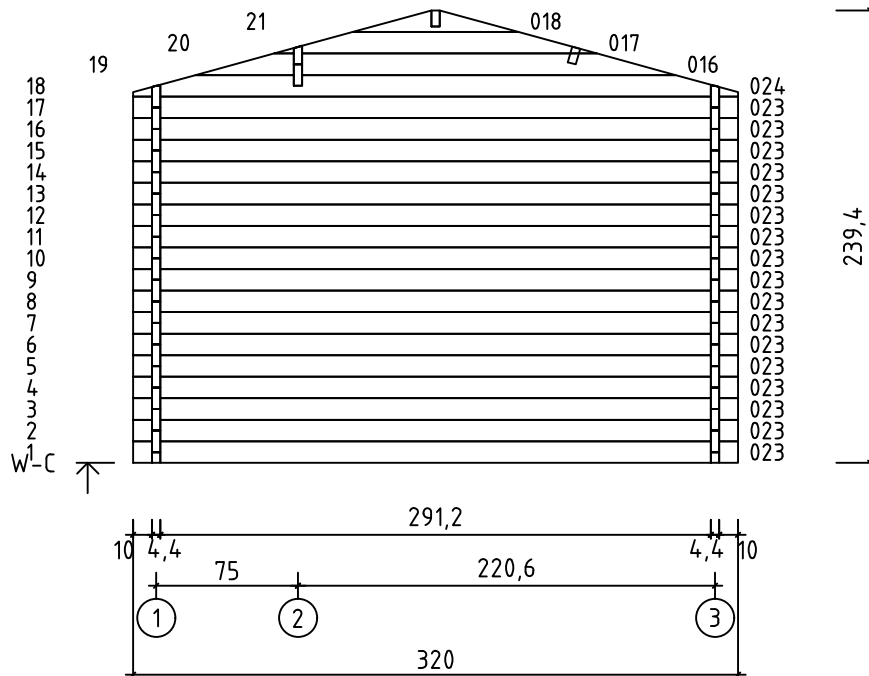
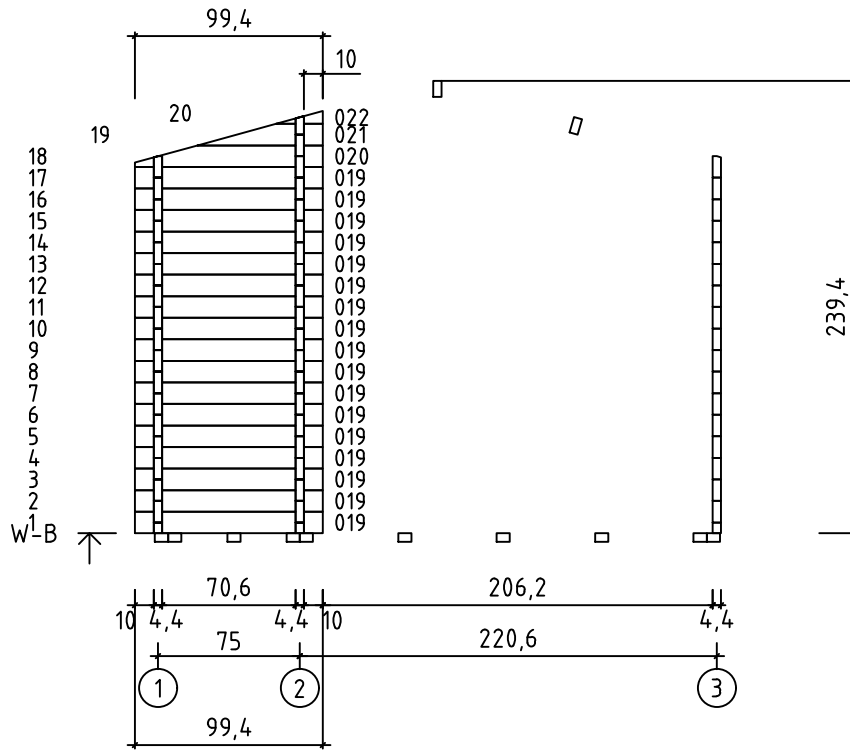

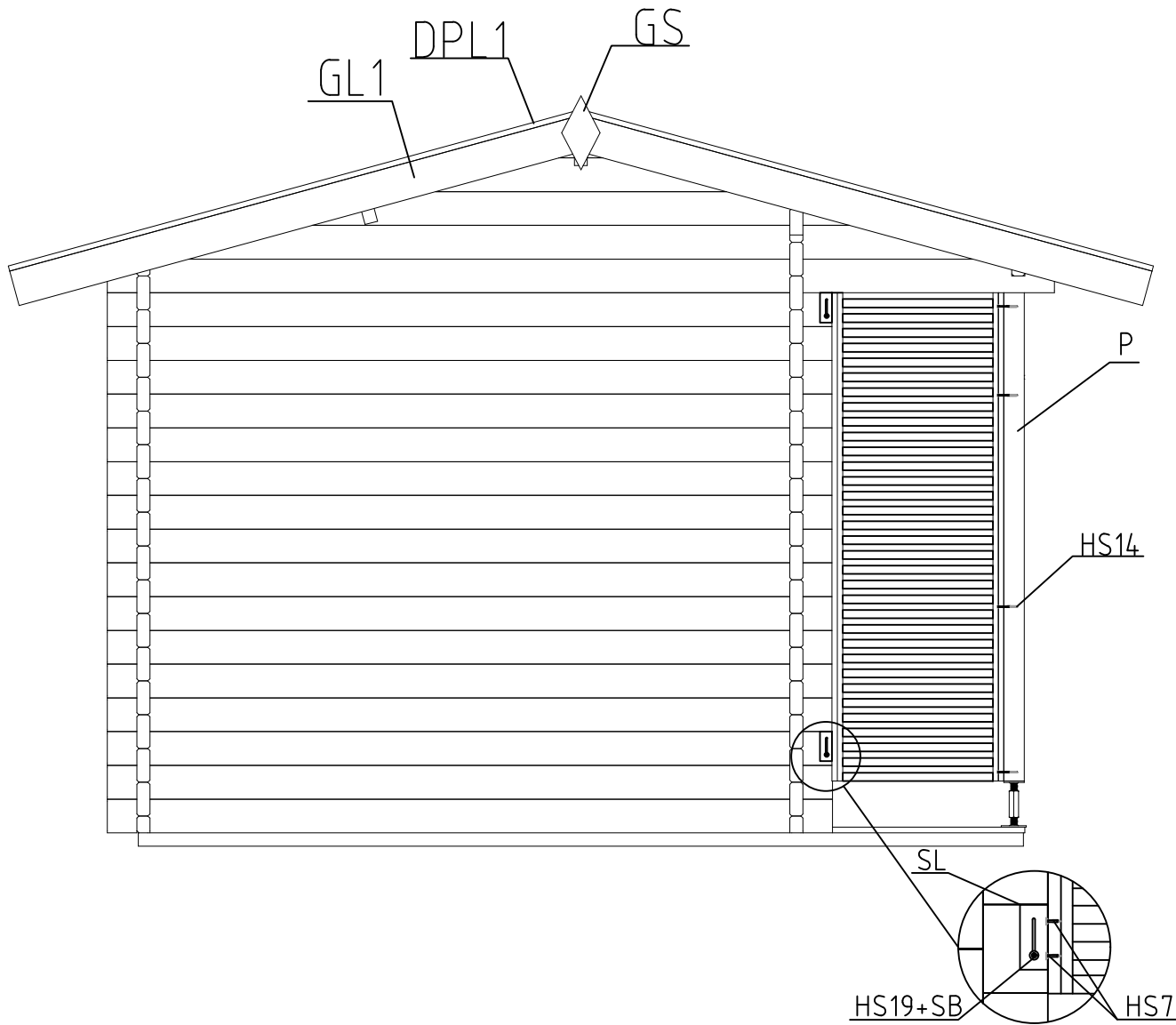



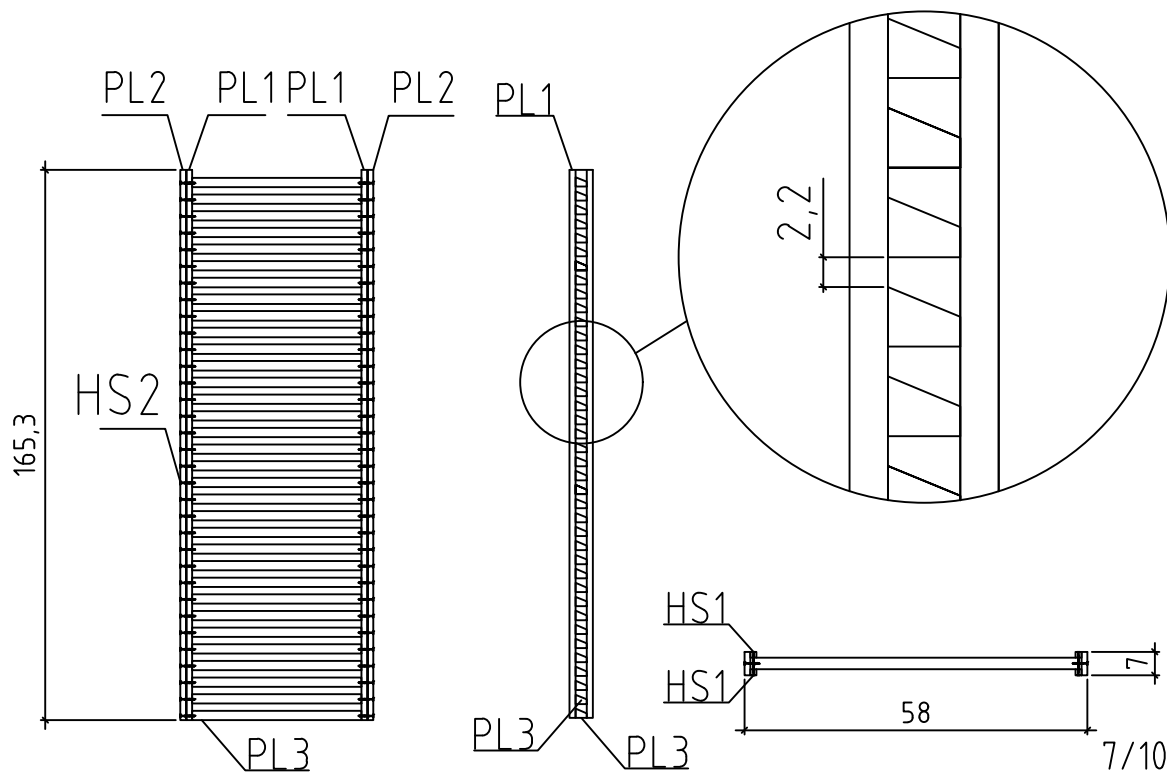

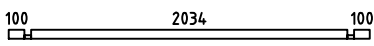

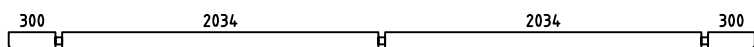

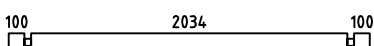
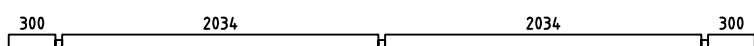
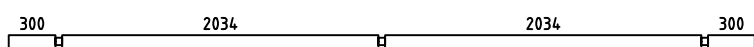
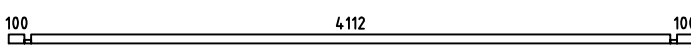
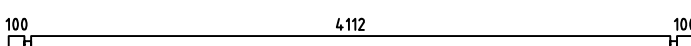
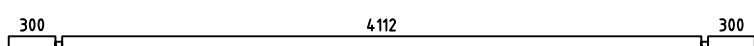
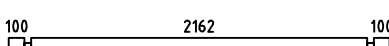
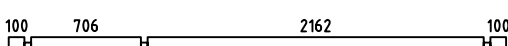
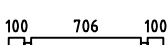
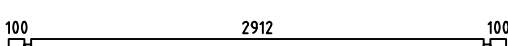
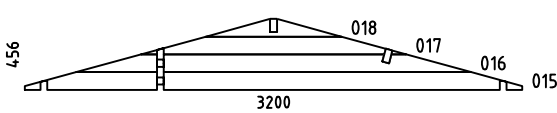
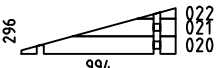
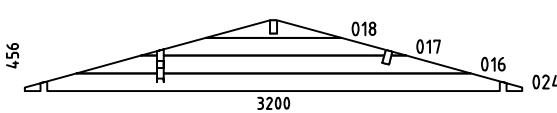



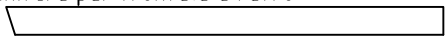







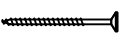



Terrace railing - Terrassenzaun - Garde-corps de terrasse - Ringhiera per terrazza - Terras rails (leuning) - Piirdeaed

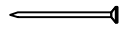
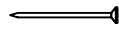
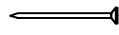
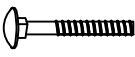

Pos	Piece list - Stückliste - Liste des pièces - Elementi - Stuklijst - Tükítabel 21.02.2018 Art.Nr. 4423202	8/10	Q	P (mm)	L (mm)
001			1	44x57	2322
002			32	44x114	398
003			16	44x114	398
004			1	44x120	4800
005			2	44x57	409
006			32	44x114	409
007			1	44x114	2322
008			1	44x114	4800
009			1	44x98	4800
010			1	44x57	4400
011			16	44x114	4400
012			1	44x120	4800
013			16	44x114	2450
014			1	44x114	3200
019			17	44x114	994
023			17	44x114	3200
WA-1			1		
WB-1			1		
WC-1			1		
IAR2	Foundation - Fundament - Fondation - Fondamenta - Fundering - Immutatud alusraam 		7	70x45	4050
IAR1	Foundation - Fundament - Fondation - Fondamenta - Fundering - Immutatud alusraam 		2	70x45	2990

Pos	Piece list - Stückliste - Liste des pièces - Elementi - Stuklijst - Tükitalabel 21.02.2018 Art.Nr. 4423202	9/10	Q	P (mm)	L (mm)
IAR3	Foundation - Fundament - Fondation - Fondamenta - Fundering - Immutatud alusraam 		1	70x45	2047
A-PR1	Roof beam - Dachbalken - Panne de toit - Perlina del tetto - Gordingen / dakbalk - Pärilin 300 412 300 		2	44x140	4800
	Floor boards - Fussbodenbretter - Lame de plancher - Pavimento - Vloerhout - Põrandalaud 		23	90x18	2908
	Floor boards - Fussbodenbretter - Lame de plancher - Pavimento - Vloerhout - Põrandalaud 		23	90x18	2158
	Terrace boards - Terrassenbretter - Plancher de terrasse - Piattaforme terrazzo - Terrasvloer - Terrassilaud 		22	90x19	750
	Roof boards - Dachbretter - Voliges - Perlina per tetto - Dakhout - Katuselaud 		108	90x18	1950
	Floor fillet - Fussbodenleiste - Corniere de finition du plancher - Finitura per pavimento (battisco pa) - Vloerafwerklijst - Põrandaliist 			18x18	14.03
DPL1	Roofing felt fillet - Dachpappenleiste - Baguette de fixation du feutre bitumeux - Asse per fissaggio guaina bituminosa - Afdeklijst asfaltpapier - Katusepapiiist 		4	18x58	2000
PL1	Fillet for terrace railing - Leiste für terrasse - Baguette pour corps de terrasse - Massellino di guarnizione per ringhiera - Terras lijst - Päärde liist 		4	18x18	1653
PL2	Fillet for terrace railing - Leiste für terrasse - Baguette pour corps de terrasse - Massellino di guarnizione per ringhiera - Terras lijst - Päärde liist 		2	18x70	1653
PL3	Fillet for terrace railing - Leiste für terrasse - Baguette pour corps de terrasse - Massellino di guarnizione per ringhiera - Terras lijst - Päärde liist 		33	28x34	544
P	Post - Pfosten - Poteau - Piede registrabile - Stijl - Post 		1	70x70	1710
TB-1	Fascia board - Traufbrett - Bandeau de toit - Finitura lati tetto - Gevellijst Räästalaud 		4	18x90	2400
DRV-1	Roof edge reinforcement - Dachrandverstärkung - Corniere de renfort de bord de toit - Rinforzo x tetto - Dakrand versterking - Räästatugevdus 		4	28x34	2400
KFS-1	Storm protection - Sturmleiste - Latte anti-tempete - Protezione anti vento - Stormverankering / beveiliging - Tormikinnitusliist 		4	22x45	2050
GL1	Gable moulding - Giebelleiste - Planche de rive - Finitura per frontale e retro del tetto - Gevellijst - Viitulaud 		4	18x120	2000
HS7	Screw for sliding wall tie - Schieberegler für wand - Sabot métallique pour fixation mur - Vite per fissare scorrimento a c su slitta fissata alla parete - Schuifdeur instellingen wand - Kruvi seinaliugurile 		8	3.5x20	
HS8	Screw for gable segment - Schrauben für deckblatt - Vis pour fixation losange de finition - Viti x frontali tetto - Schroef voor gevelpunt segment - Kruvi rombile 		4	3.5x35	
HS9	Screw for gable moulding - Schrauben für giebelleiste - Vis pour fixation planche de rive - Vite per fissare finiture davanti e dietro del tetto - Schroef voor gevellijst - Kruvi viitulauale 		24	3.5x50	
HS14	Screw for fixing terrace railing - Schraube für terrasse - Vis de fixation de garde-corps de terrasse - Vite per fissaggio della ringhiera al terrazzo - Schroef voor terras - Kruvi piirdeaia kinnituseks 		4	4.5x80	
HS12	Screw for covering moulding - Schrauben für deckungsprofil - Vis de fixation profils horizontaux haut inférieure et extérieur d'encadrement de porte - Vite per cornice di copertura - Schroef voor afdekprofiel - Kruvi piirdelauale 		66	4x40	
HS12	Screw for fascia boards - Schrauben für traufbretter - Vis pour fixation bandeau de toit - Viti x striscia del tetto - Schroef voor gevellijst - Kruvi räästalauale 		24	4x40	
HS12	Screw for roof edge reinforcement - Schrauben für dachrandverstärkung - Vis pour fixation corniere renfort de bord de toit - Viti x rinforzo bordo tetto - Schroef voor dakrand versterking - Kruvi räästatugevdusele 		24	4x40	

Pos	Piece list - Stückliste - Liste des pièces - Elementi - Stuklijst - Tükítabel 21.02.2018 Art.Nr. 4423202	10/10	Q	P (mm)	L (mm)
HS13	Screw for post - Schrauben für pfosten - Vis de fixation des poteaux - Viti per inviare - Schroef voor stijlen - Kruvi postile		2	4x60	
HS18	Screw for foundation - Schrauben zur befestigung fundament - Vis de fixations des poutrelles de fondations - Viti x fundamenta - Schroef voor fundering - Kruvi alusraamile		15	5x120	
HS18	Screw for roof beams - Schrauben für dachbalken - Vis pour fixation pannes de toit - Viti per perline del tetto - Schroef voor gordingen / dakbalken - Kruvi pärlinitel		4	5x120	
HS18	Screw for foundation - Schrauben zur befestigung fundament - Vis de fixations des poutrelles de fondations - Viti x fundamenta - Schroef voor fundering - Kruvi alusraamile		3	5x120	
HS18	Screw for gable - Schrauben für giebel - Vis pour fixation des pignons - Viti per timpano - Schroef voor gevelpunt - Kruvi viilude kinnitamiseks		6	5x120	
HS16	Screw for 1. wall beam - Schraube für 1. bohlenreihe - Vis de fixations 1ere rangée de madriers avec poutrelles de fondations - Vite fissaggio alle fondamenta - Schroef voor 1 wandbalk - Kruvi poollauale		10	5x90	
HS19	Screw for sliding wall tie - Schieberegler für wand - Sabot métallique pour fixation mur - Vite per fissare scorrimento a c su slitta fissata alla parete - Schuifdeur instellingen wand - Kruvi seinaliugurite		2	6x40	
HS20	Screw for post height adjustment - Schrauben für regulierungsschraube für pfosten - Vis de fixation de support réglable de poteau - Viti per fissare ed aggiustare l'altezza del palo verticale - Schroef voor hoogte instelling stijlen - Kruvi vajumispolidile		8	6x50	
NF2	Zn nail for floor fillet - Zn nagel für fussbodenleiste - Pointe pour corniere de finition du plancher - Chiodi x fissaggio pavimento - Spijker(nagel) voor vloer afdeklijst - Nael põrandaliistule		29	1.4x40	
SH44	Hammer block - Schlagholz - Calle de frappe - Blocco di legno da usare come cuscinetto quando si usa il martello - Slagklos - Löögiklots		1		
SFS	Nut for storm protection - Schraubenmutter für sturmleiste - Ecrou pour latte anti-tempete - Dado x asta protezione vento - Moer voor stromverankering - Mutter tormikinnitusliistule		8	D8	
NF3	Zn nail for terrace - Zn nagel für terrassenbretter - Pointe pour plancher de terrasse - Chiodo zincato per terrazza - Spijker(nagel) voor terrasvloer - Nael terrasilauale		132	2.1x50	
NF4	Zn nail for roof - Zn nagel für dachbretter - Pointe pour fixation voliges de toit - Chiodi x perline tetto - Spijker(nagel) voor dakhout - Nael katuselauale		338	2x50	
NF4	Zn nail for floor - Zn nagel für fussbodenbretter - Clous pour plancher - Chiodi x perline pavimento - Spijker(nagel) voor vloer - Nael põrandalauale		287	2x50	
NF5	Zn nail for roofing felt fillet - Zn nagel für dachpappenleiste - Pointe pour baguette de fixation feutre bitumeux - Chiodi x carta bituminosa x tetto - Spijker(nagel) voor asfaltpapier afdeklijst - Papiilistunael		20	2x40	
BFS	Bolt for storm protection - Bolzen für sturmleiste - Boulon pour latte anti-tempete - Bullone x asta protezione vento - Bout voor stormankerlat - Puidupolt tormikinnitusliistule		8	8x80	
GS	Gable segment - Deckblatt - Losange de finition - Decorazione in legno x frontale tetto - Gevelpunt segment - Romb		2		
DFS	Washer for storm protection - Dichtscheibe für sturmleiste - Rondelle pour latte anti-tempete - Rondella x asta protezione vento - Afdichting voor storm strip - Seib tormikinnitusliistule		8	D8	
SB	Plain washer - Unterlegscheibe - Rondelle plate - Rondella piana - Sluitring - Seib sein ja sarikaliugurite 6 mm		2		
SL	Sliding wall tie - Schieberegler für wand - Sabot métallique pour fixation mur - Cravatta parete scorrevole - Schuifregelaar voor wand - Seinaliugur		2	35x35x130	
	Post height adjustment - Pfostenträger verstellbar - Support réglable de poteau - Piede registrabile in altezza - Stelschroef voor stijlpost - Vajumispoltt		1	D20	
	Window - Fenster - Fenetre - Finestra - Raam - Aken	560x1780 AK.1.100.TPSP DGP+	1		
	Window - Fenster - Fenetre - Finestra - Raam - Aken	560x1780 AK.1.100.TPSV DGP+	1		
	Door - Tür - Porte - Porte - Deur - Uks	1494x1850 TUK.1.100.TPVP.MMc DGP+	1		



Pos	10.11.2017	Piece list - Stückliste - Liste des pièces - Elementi - Stuklijst - Tükítabel 560x1780 AK.1.100.TPSP DGP+	1/1	Q	P (mm)	L (mm)
-----	------------	--	-----	---	-----------	-----------

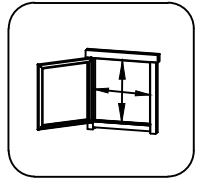
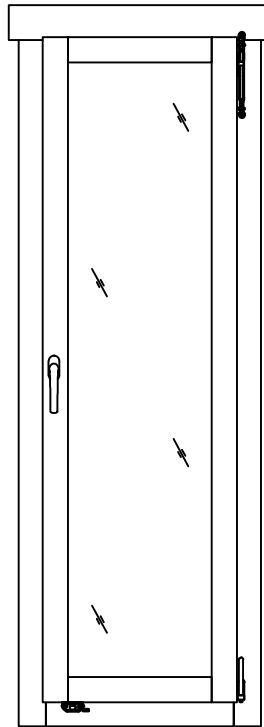



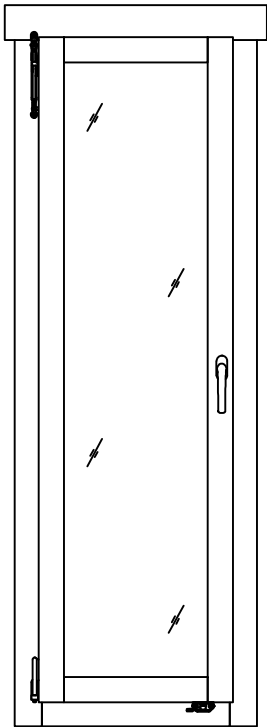
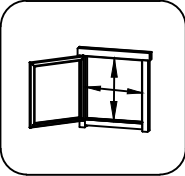

Glass size - Glasgröße - Taille de la vitre - Misura del vetro - Glas afmeting - Klaasi mõõt: 390x1602 mm

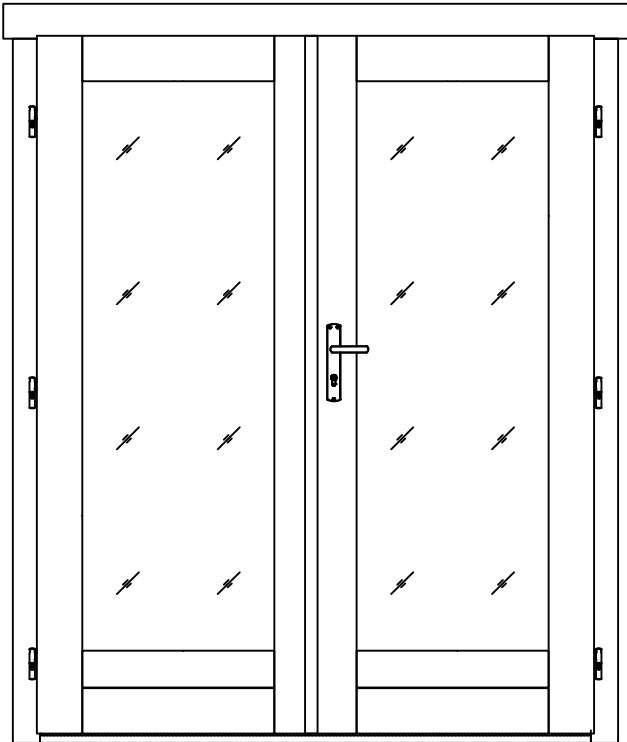
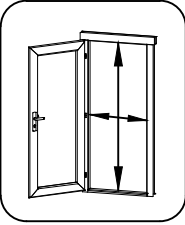
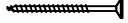
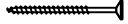
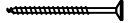

460x1684 mm

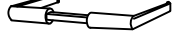
FS2	Window handle fittings - Fenstergriff - Poignée de fenetre - Maniglia c/ferramenta - Raamhendel -/grendel -/klink - Aknalink		1		
-----	---	---	---	--	--

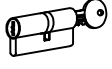
Pos	10.11.2017 Piece list - Stückliste - Liste des pièces - Elementi - Stuklijst - Tükitalabel 560x1780 AK.1.100.TPSV DGP+	1/1	Q	P (mm)	L (mm)
	<p data-bbox="256 152 1289 183">Glass size - Glasgröße - Taille de la vitre - Misura del vetro - Glas afmeting - Klaasi mõõt: 390x1602 mm</p>   <p data-bbox="1362 349 1497 376">460x1684 mm</p>				
FS2	<p data-bbox="261 2130 1023 2186">Window handle fittings - Fenstergriff - Poignée de fenetre - Maniglia c/ferramenta - Raamhendel -/grendel -/klink - Aknalink</p>		1		

Pos	21.02.2018	Piece list - Stückliste - Liste des pièces - Elementi - Stuklijst - Tükítabel 1494x1850 TUK.1.100.TPVP.MMc DGP+	1/1	Q	P (mm)	L (mm)
	Glass size - Glasgröße - Taille de la vitre - Misura del vetro - Glas afmeting - Klaasi mõõt: 514x1486 mm				  1394x1768 mm	
HS4	Screw for door fillet - Schraube zur Befestigung türleiste - Vis pour fixation baguette d'arrêt de porte - Viti per massellino della porta - Schroef voor deurlijst - Kruvi ukse kokkuvaltšiliistule				5	3x30
HS16	Screw for door jamb - Schraube für Türrahmen - Vis de fixation partie haute avec montants du cadre de porte - Viti x fissaggio montanti porte - Schroef voor deurkozijn - Kruvi ukse lengile				4	5x90
HS25	Screw for doorstep - Schrauben für swelle - Vis pour fixation barre de seuil - Vite per soglia della porta - Schroef voor deurdorpel - Kruvi lävepakule				3	4.5x65
MH	Male bolt hinge for door - Türband - Partie male de paumelle de porte - Cerniera anube x porta - Scharnier bout - Reguleeritav polthing isane				6	14x80
HC	Covers for door hinges - Schutzkappe für Türband - Couverture de paumelle de porte - Copertura delle cerniere della porta - Afdek kap voor deurscharnier - Reguleeritava polthinge kate				12	
TL4	Door handle fittings - Türgriff - Poignée de porte - Maniglie - Deurhendel / klink - Ukse käepide				1	
TL5	Set of door lock covers - Schlossblenden - Set de garnitures de porte - Copertura serrature - Slot sluitplaat set - Ukse lukuplaat				1	
	Cylinder lock - Zylinderschloss - Barillet de porte - Serratura - Cylinder slot - Ukse lukusüdamik				1	30x35
	Striker for barrel bolt - Hülse für Grendelriegel - Gache au sol du targette - Boccola per fermo della porta - Huls voor vergrendelingsschuif - Vasturaud ukse servariivile				2	