

Oswestry  
Art. Nr. 2852300  
1/13

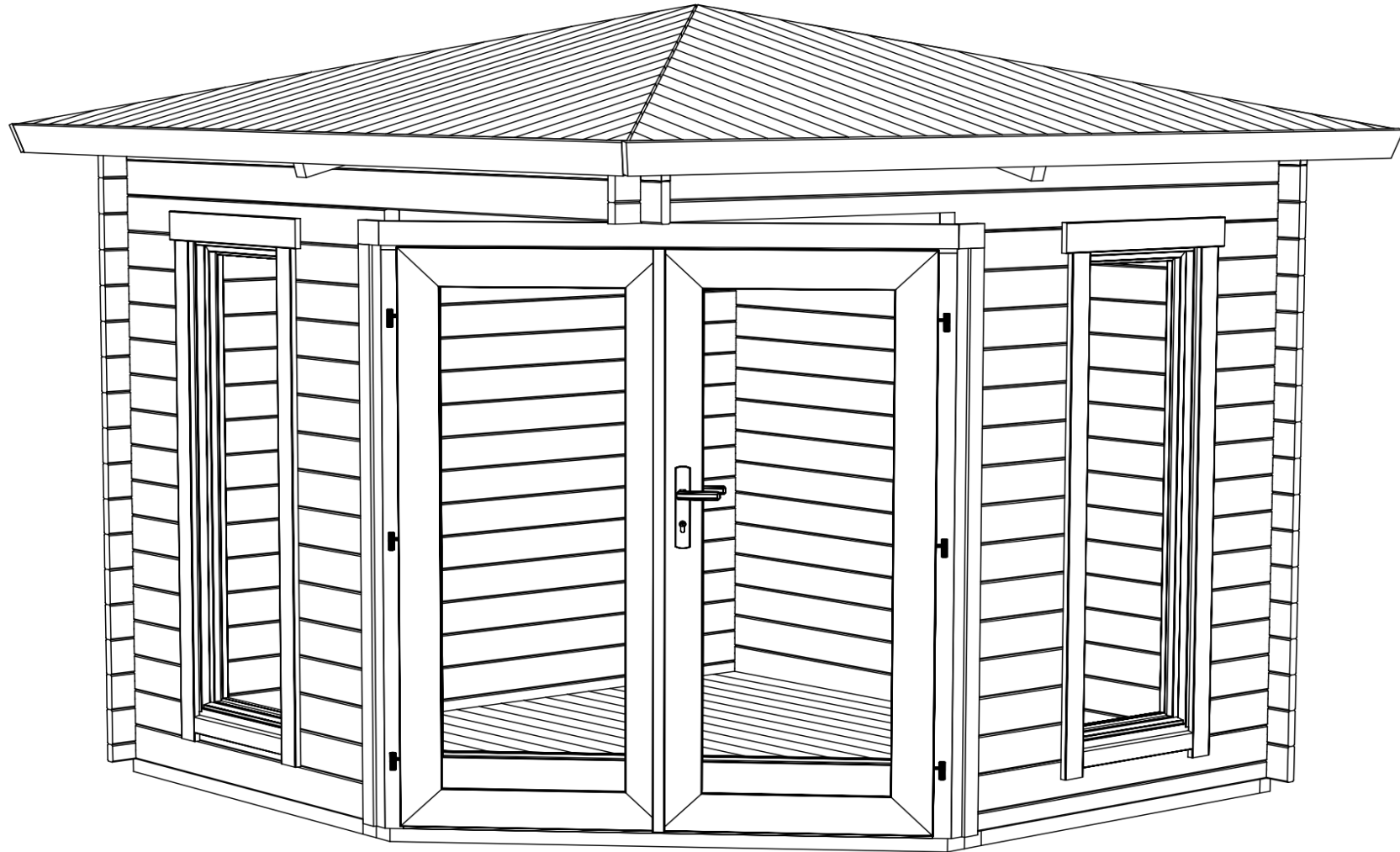

Art. Nr. 2852300

Groundplan - Grundplan - Plan de masse - Planimetria -  
Plattegrond - Põhiplaan

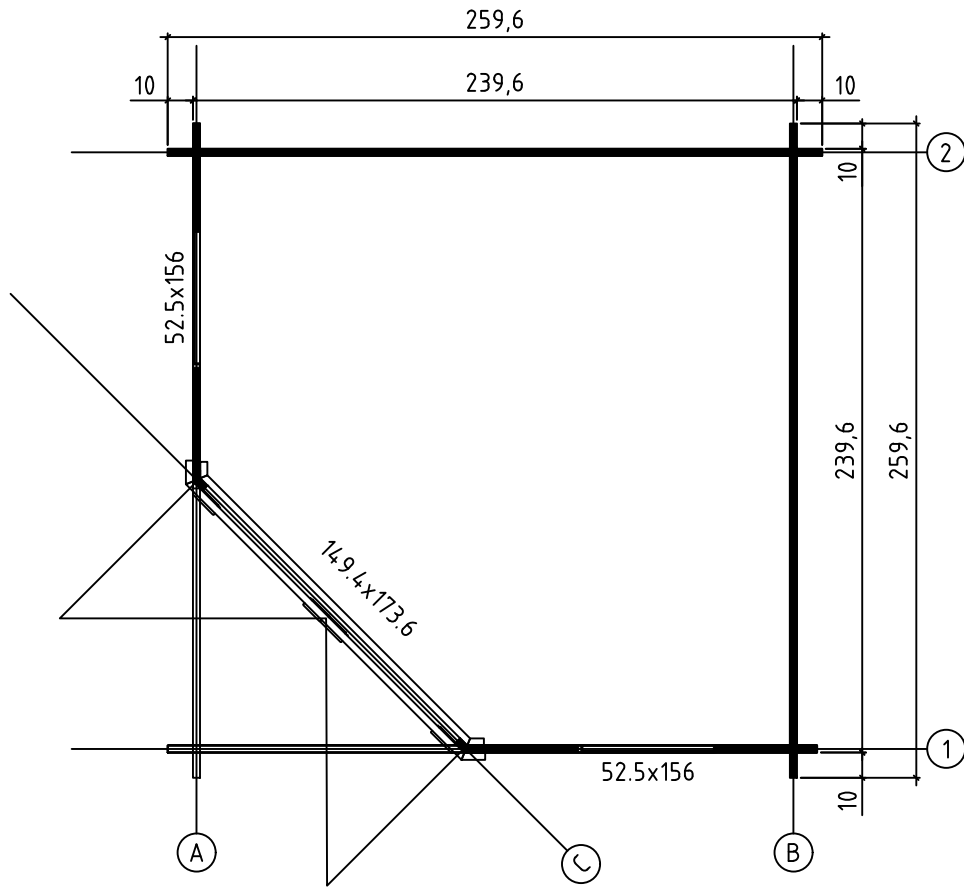

Foundation - Fundament - Fondation - Fondamenta - Fundering -  
Immutatud alusraam

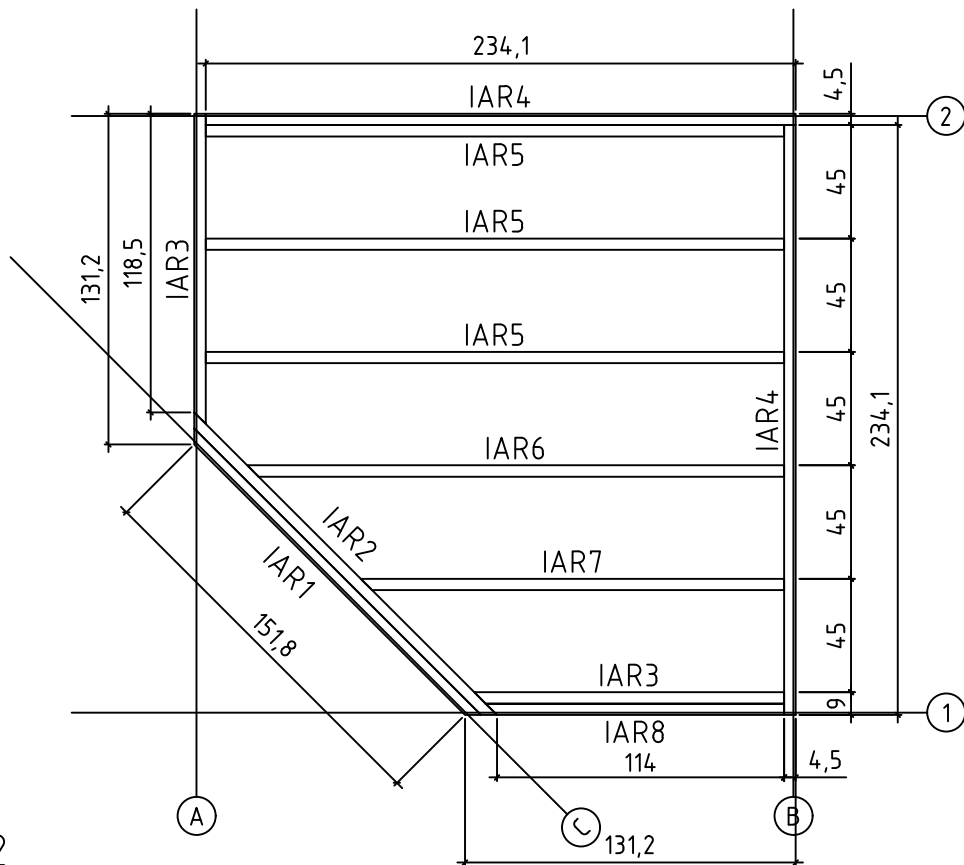

Art. Nr. 2852300

Floor boards - Fussbodenbretter - Plan pose plancher - Pavimento -  
Vloerhout - Põrandalaudis

Mounting direction - Aufbauschrütte - Instruction de montage - Modo di  
montaggio - Montage richting - Laudise ladumise suund

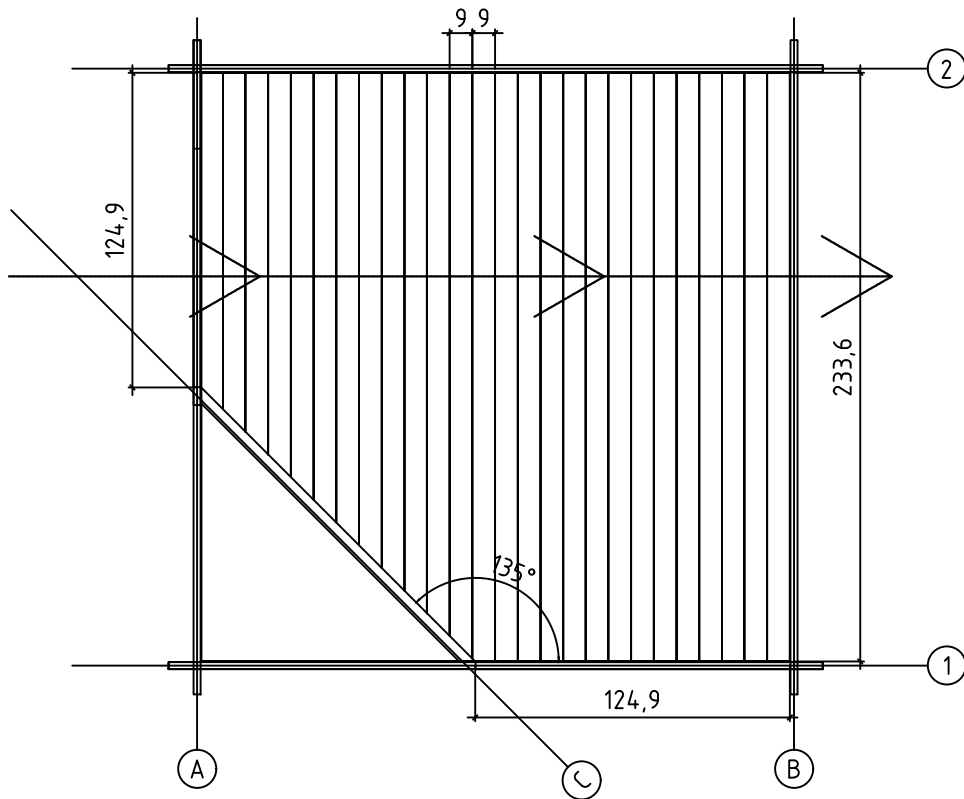

Overhead beams - Deckenbalken - Solives - Travi a vista -  
Overlopende balken - Laetalade konstruksioon

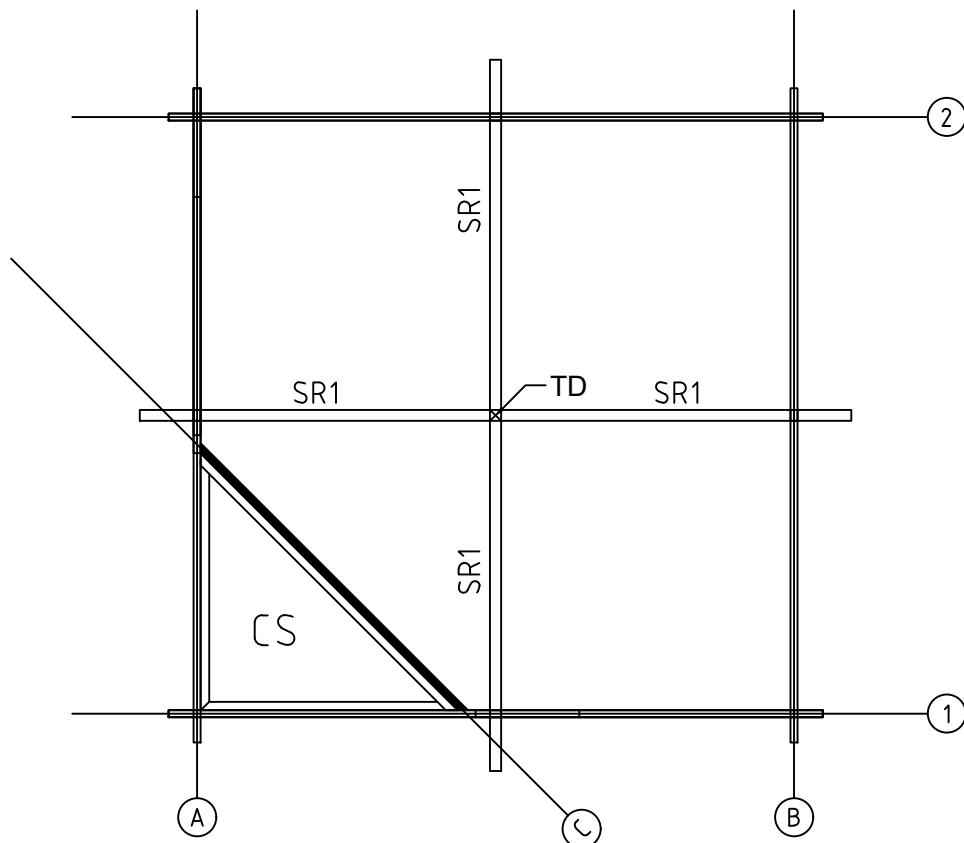

Art. Nr. 2852300

- Diagonals must be equal - Prüfung diagonale Austrichtung A=B
- Controle des diagonales A=B - Le diagonali devono essere eguali
- Gelijkbenige diagonaal - Diagonaalid peavad olema võrdsed A=B

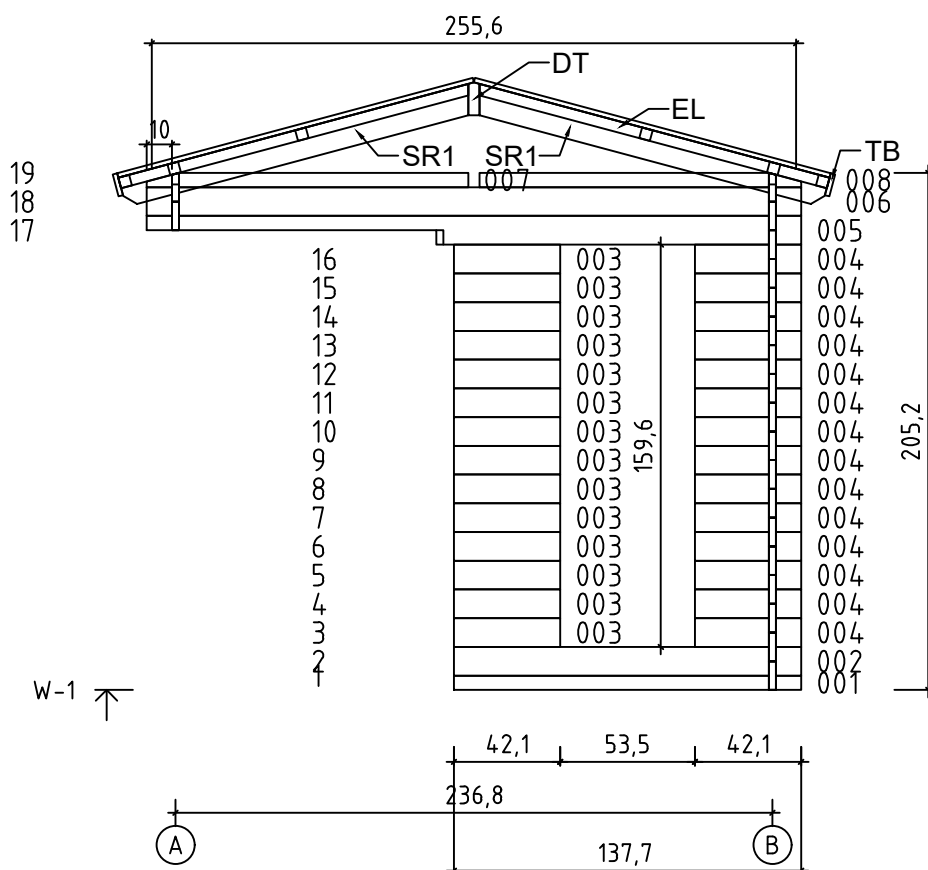
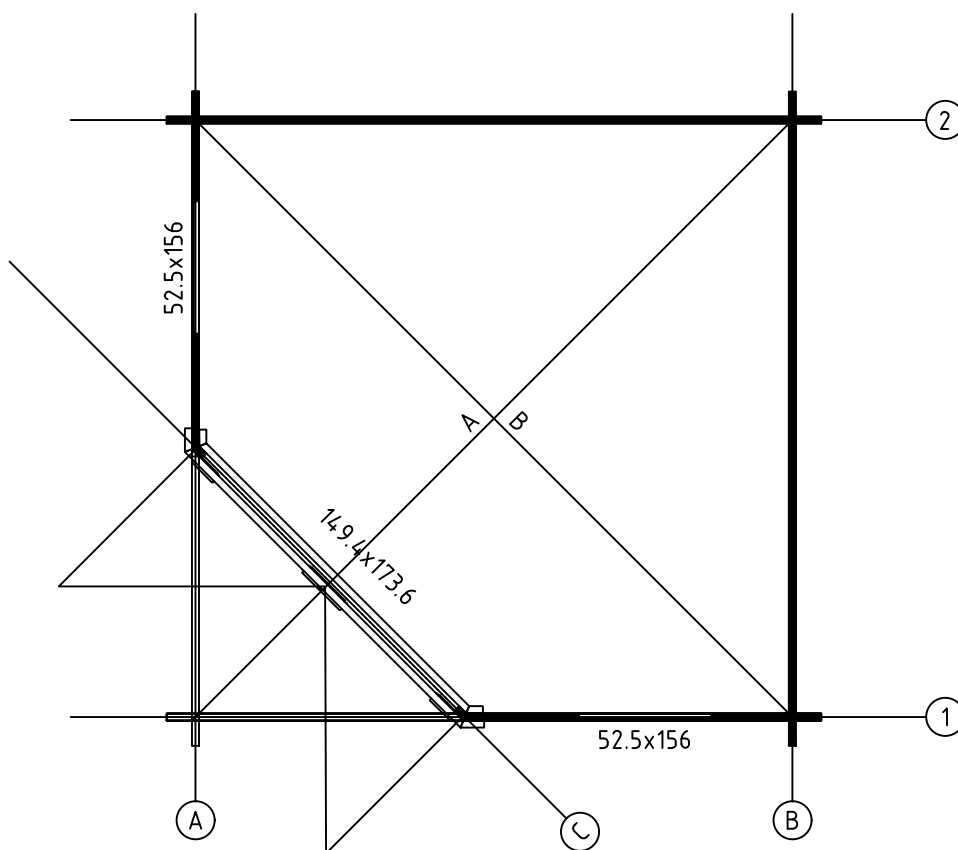

Art. Nr. 2852300

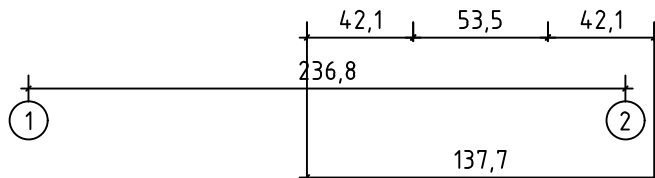
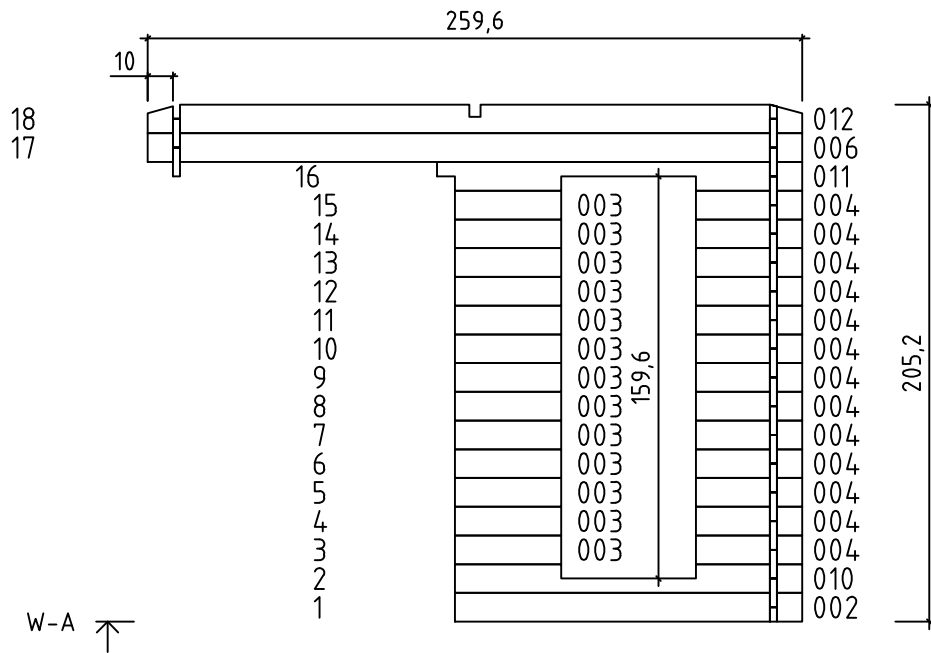
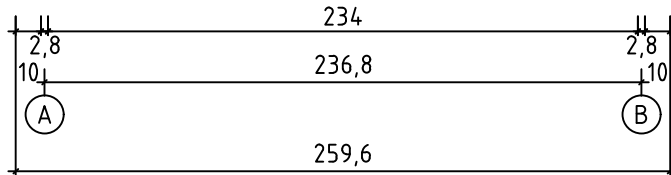
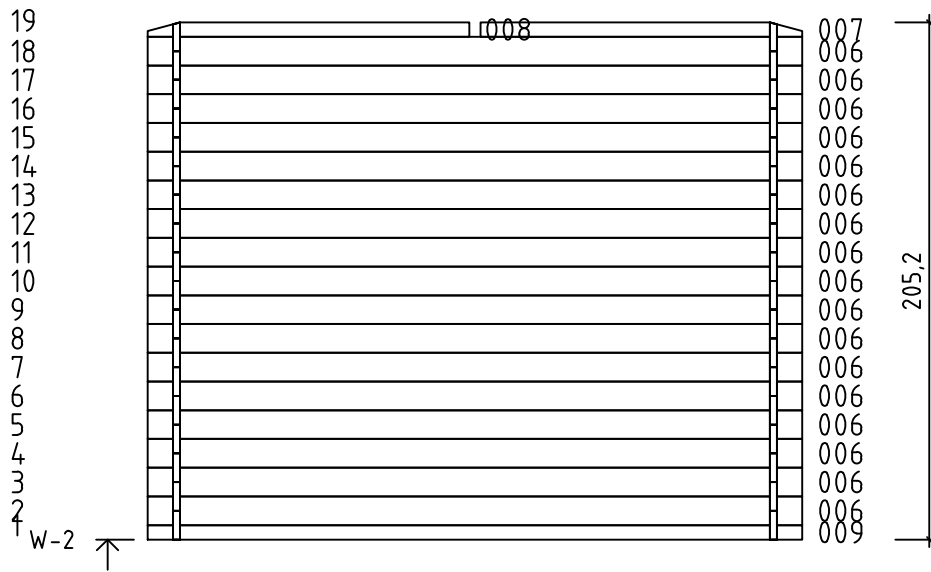

Art. Nr. 2852300

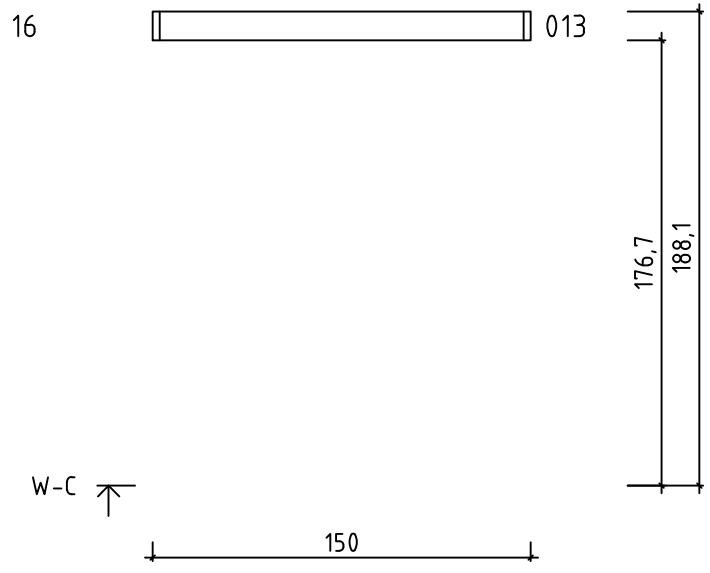
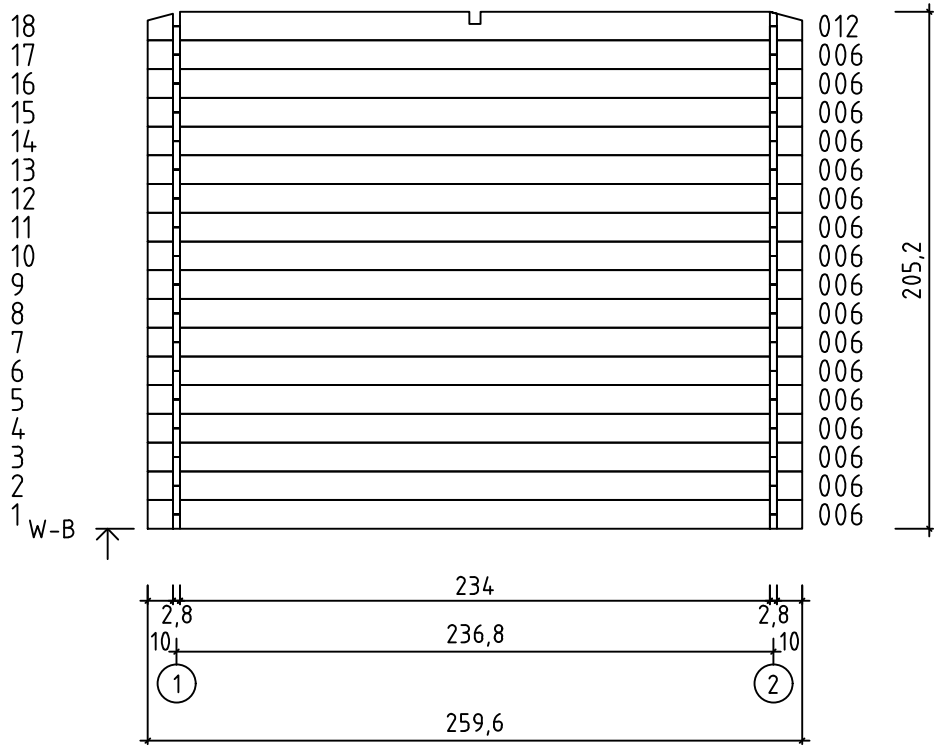

Art. Nr. 2852300

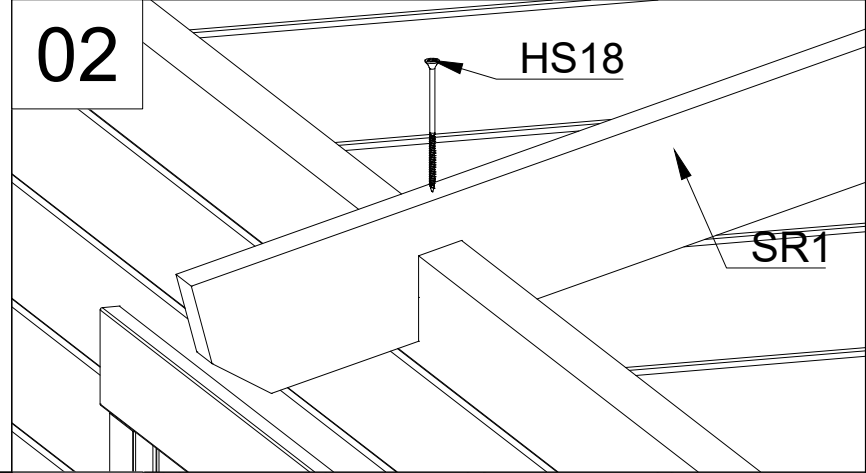
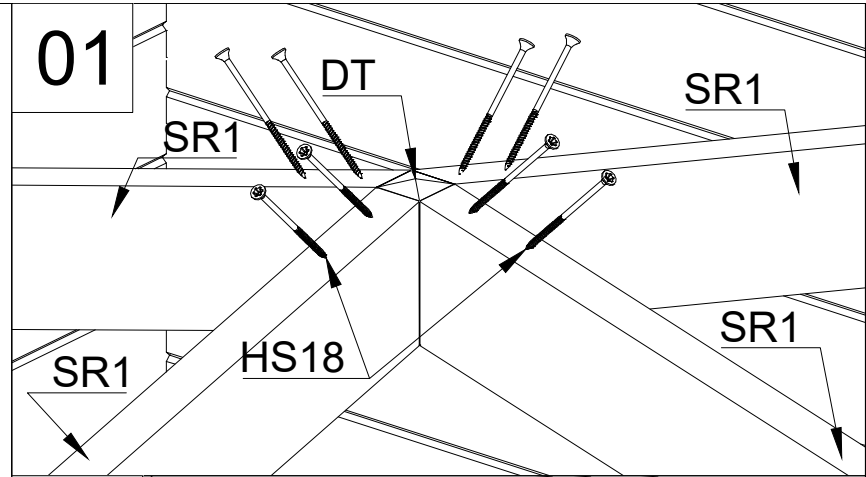
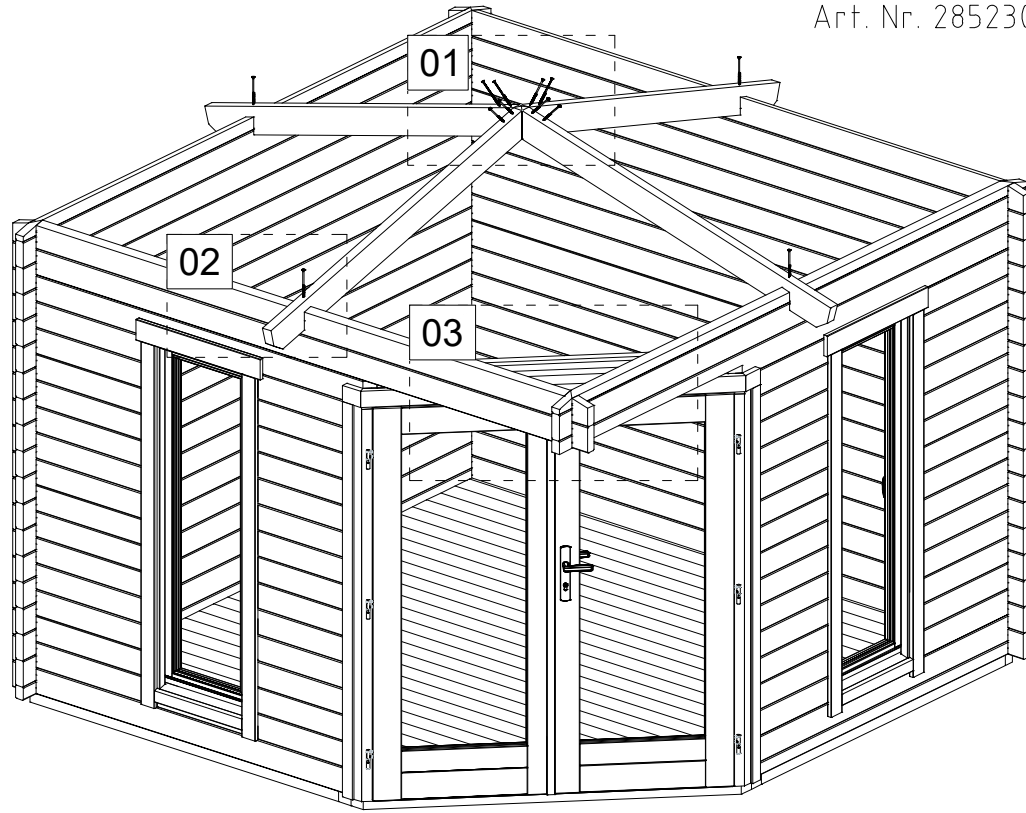

03

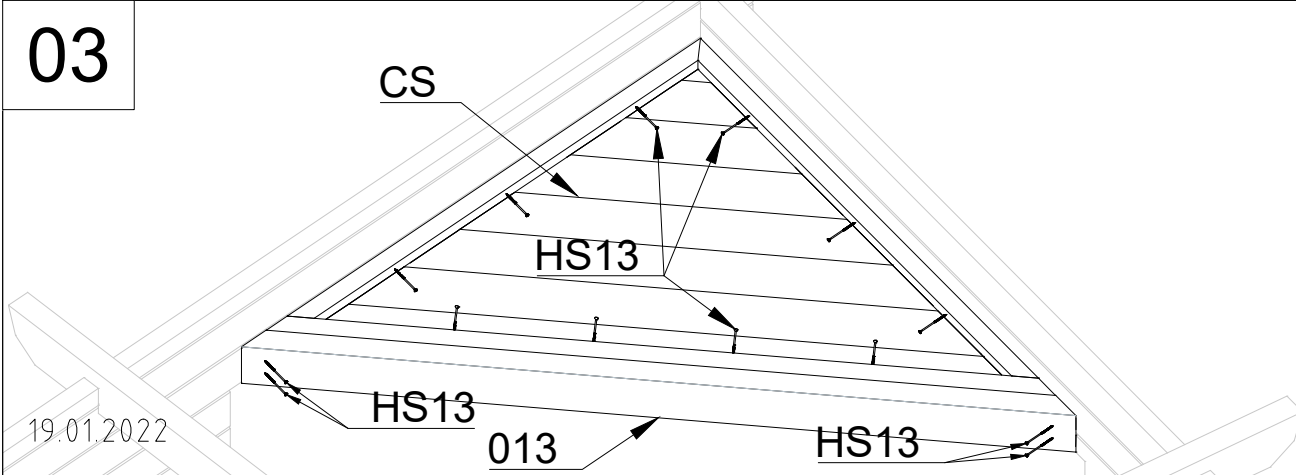

19.01.2022

03

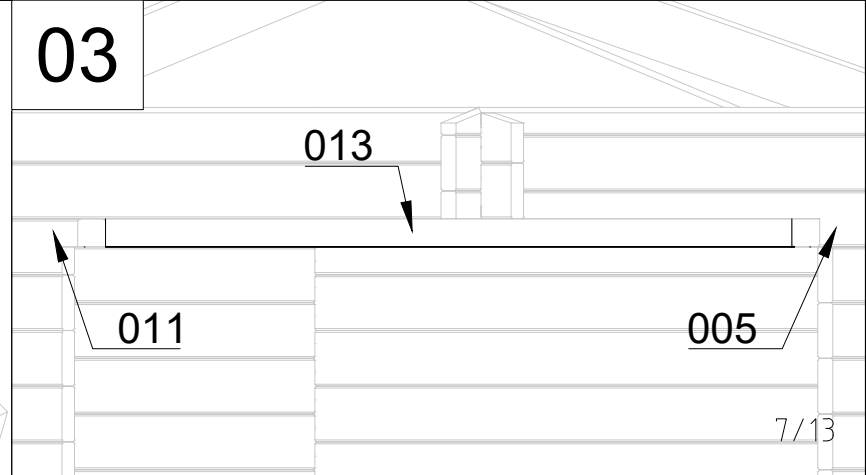

7/13

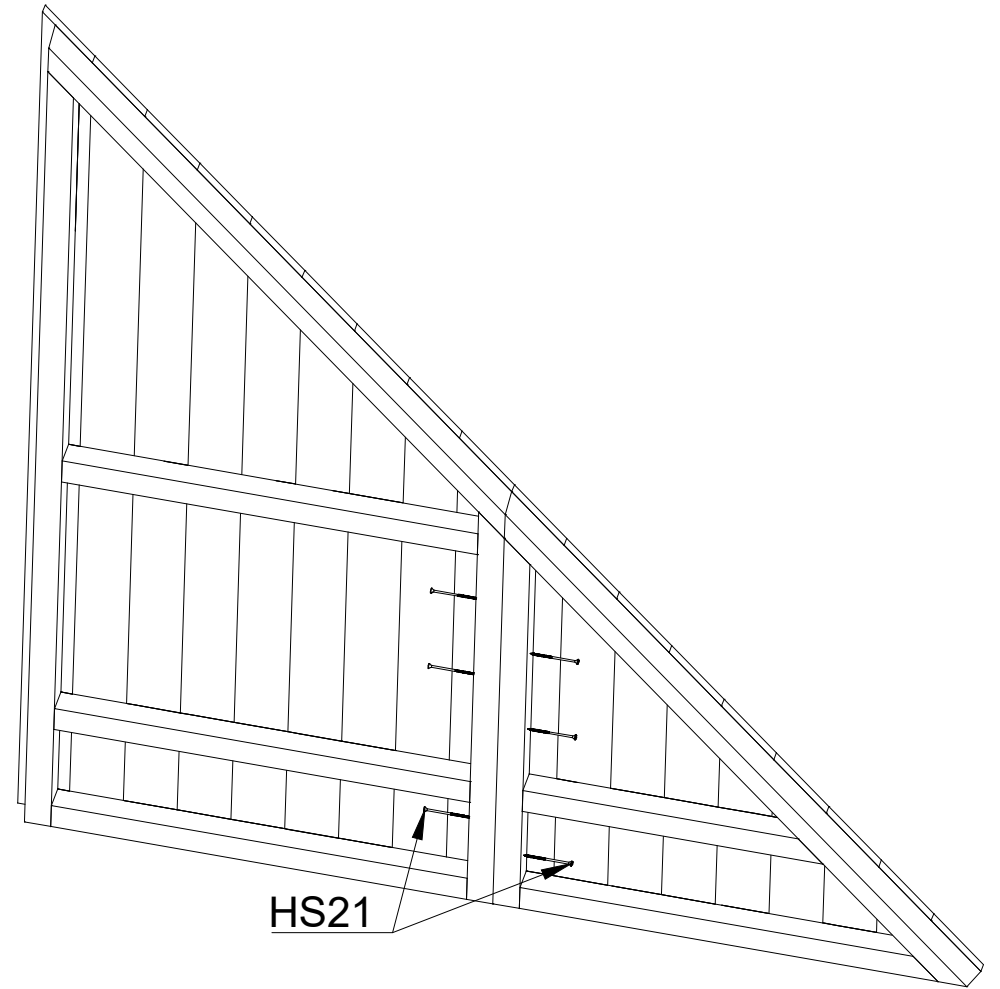
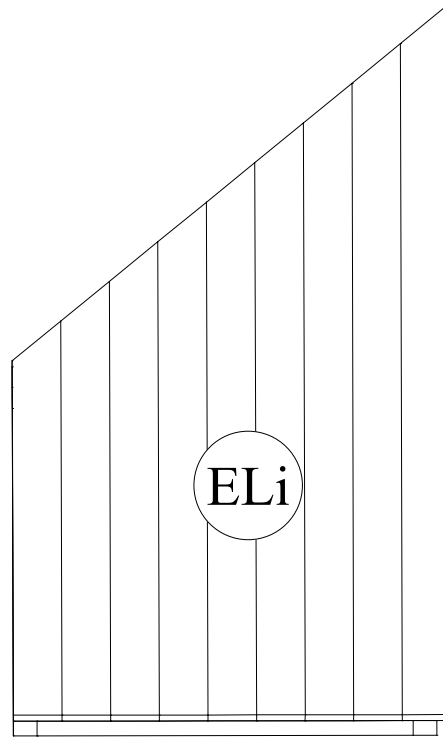
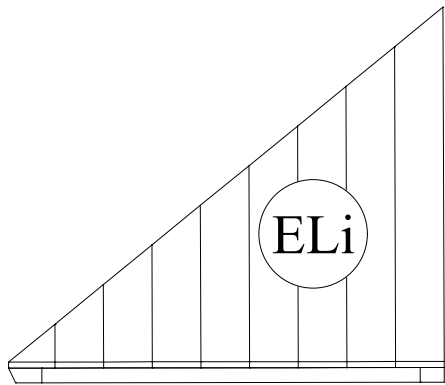



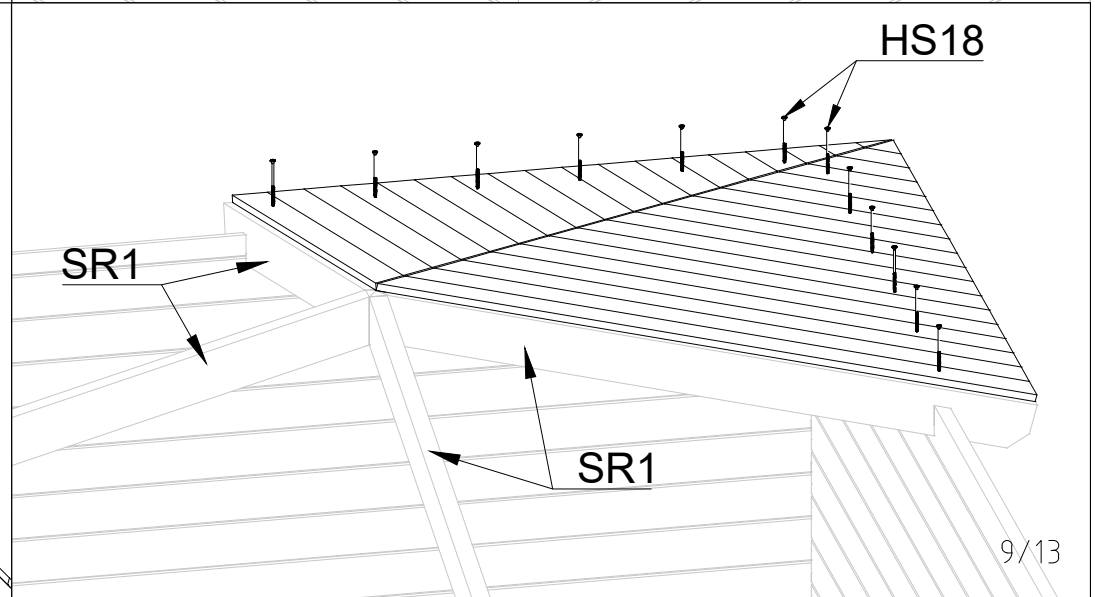
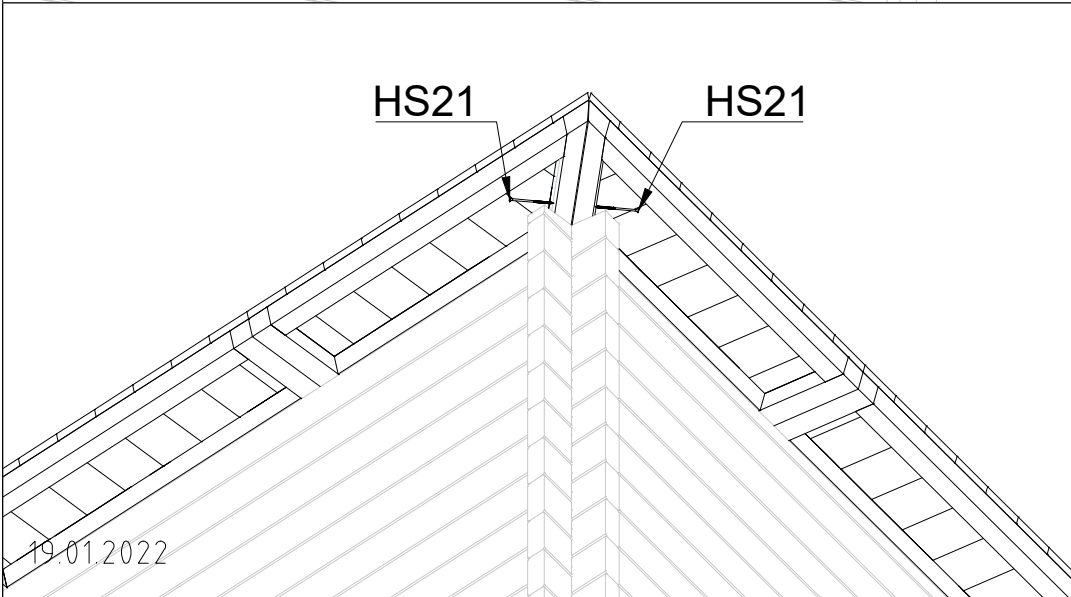
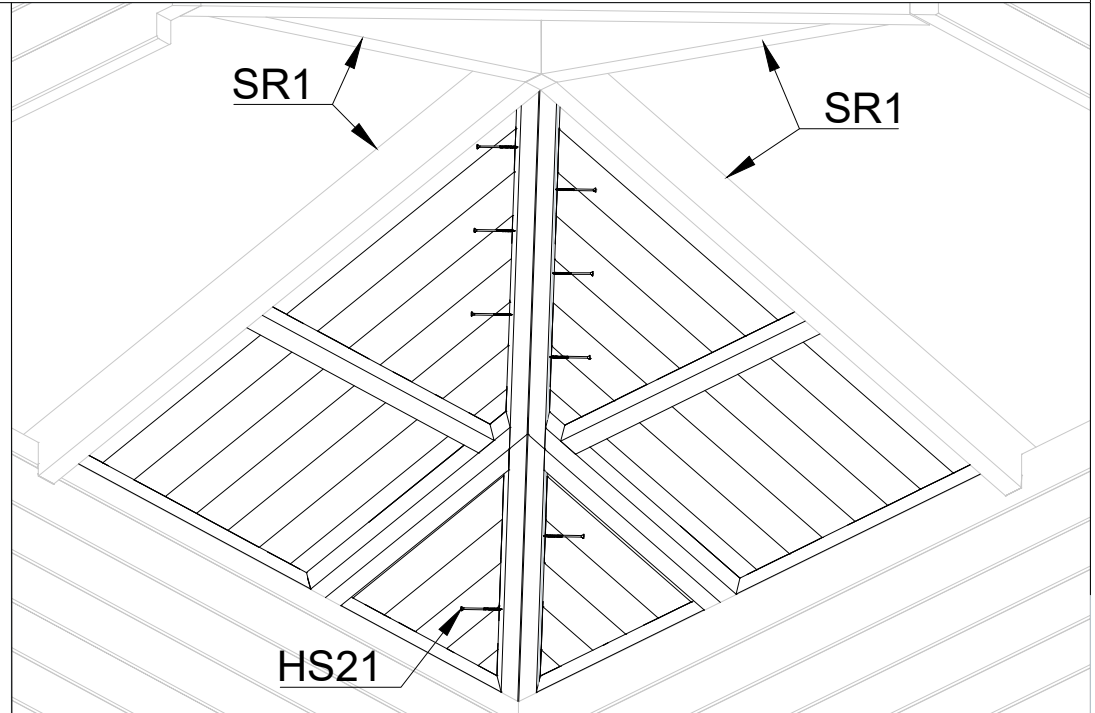
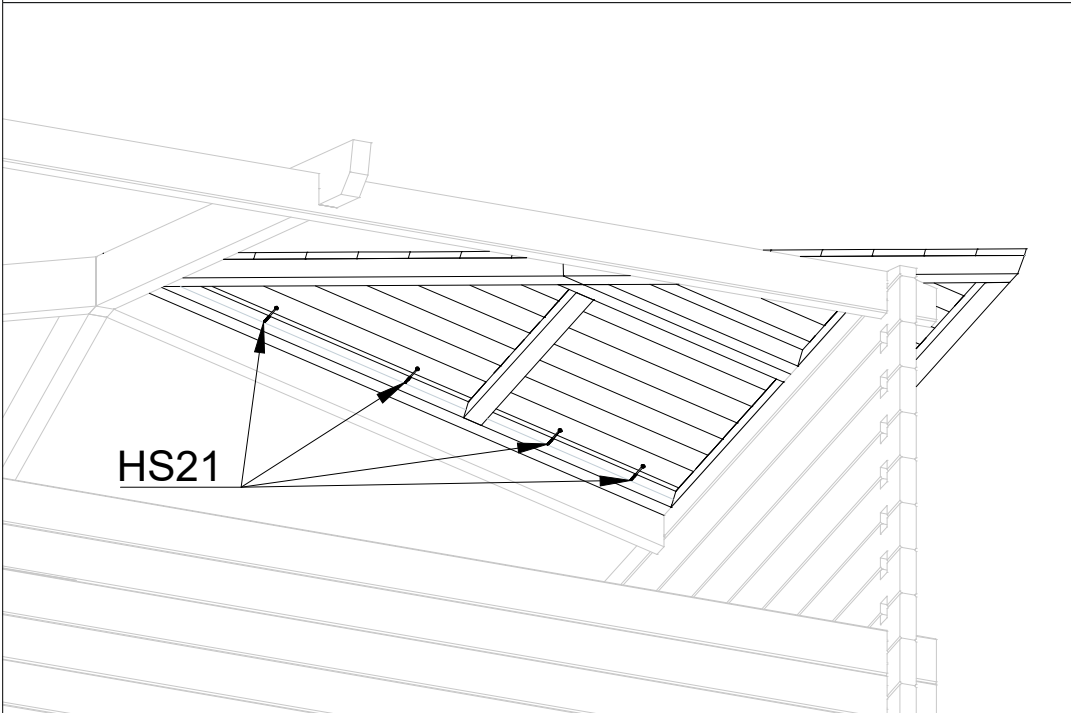

Art. Nr. 2852300

1

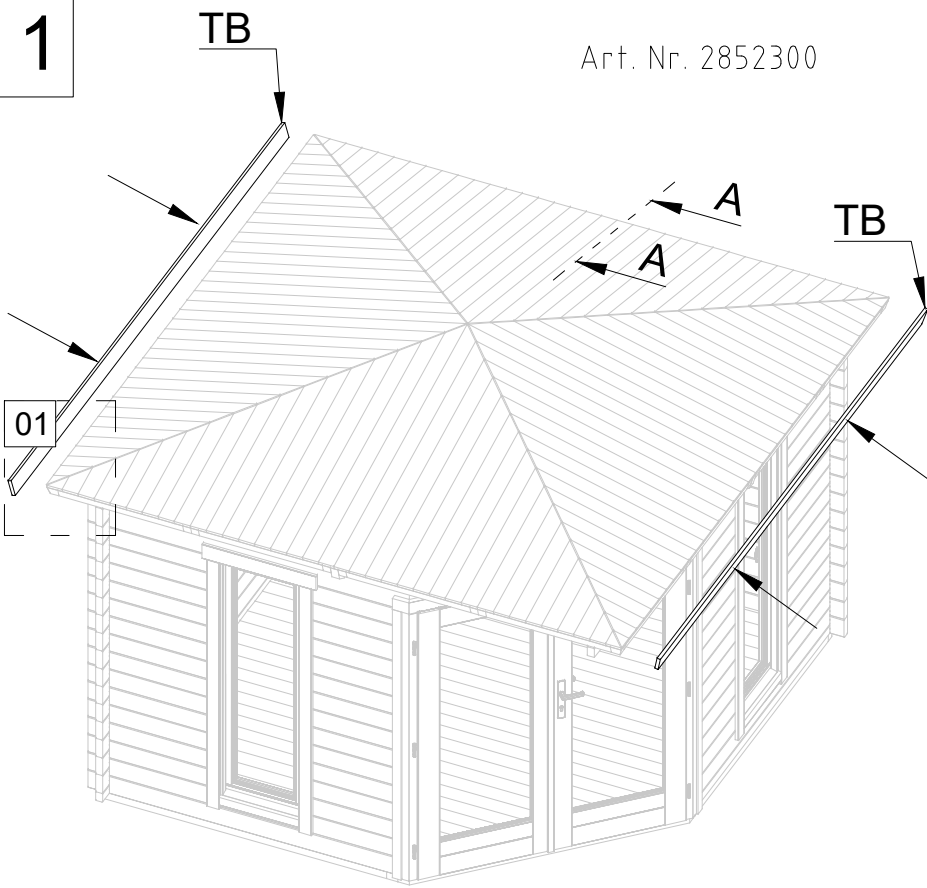

A-A

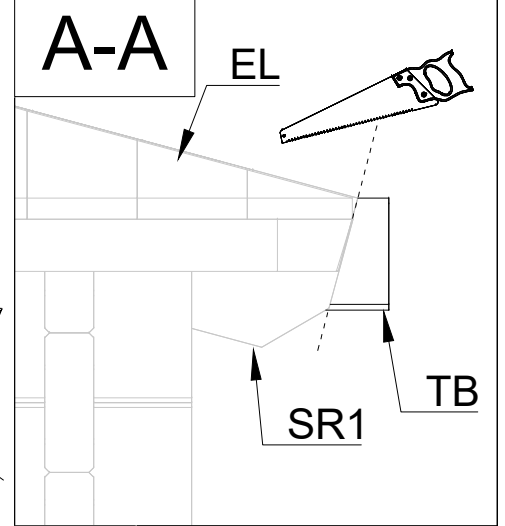

01

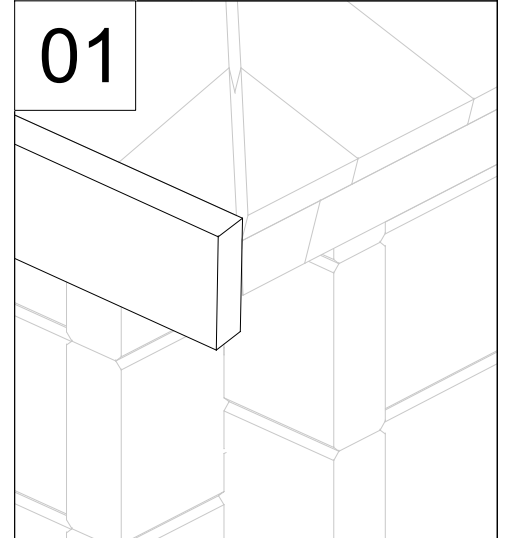

2

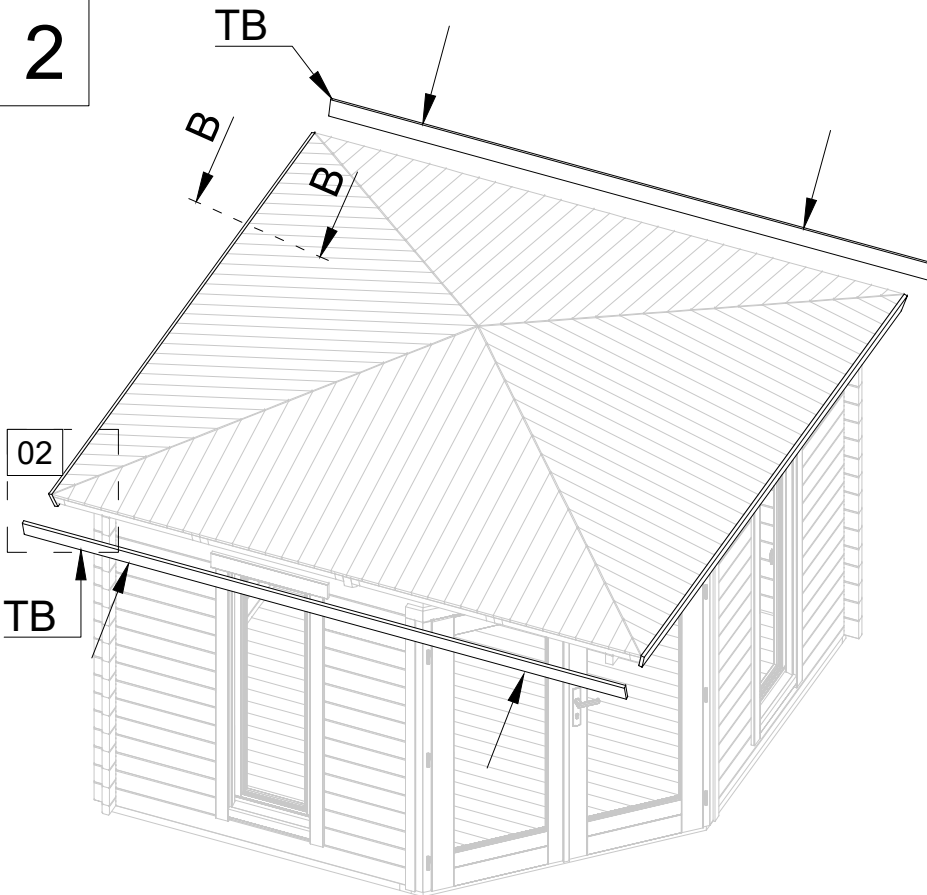



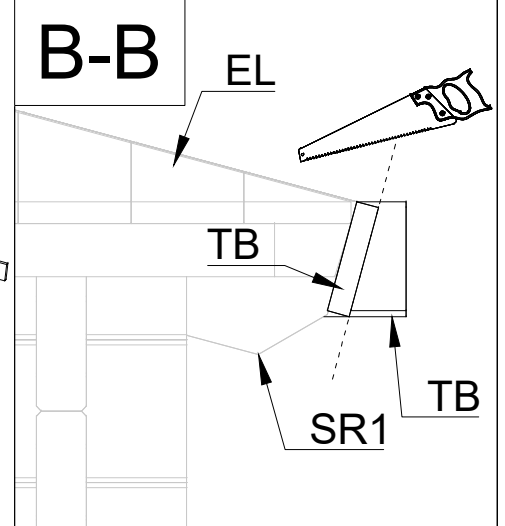



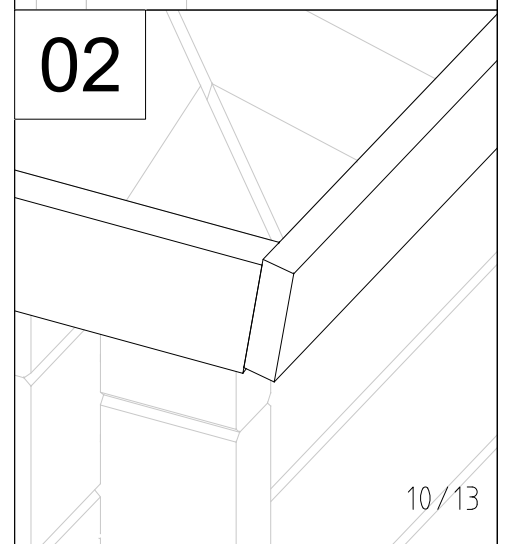

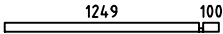
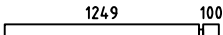

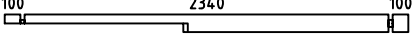
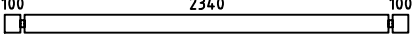
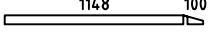
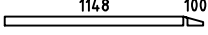
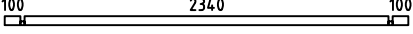
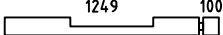
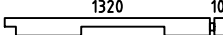
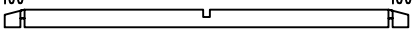









B-B

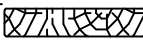
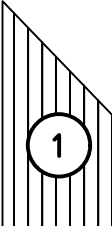
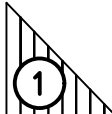
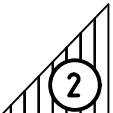
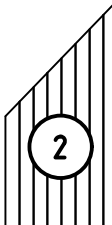
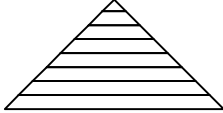
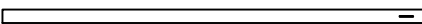

02

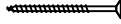
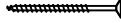
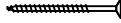
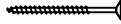
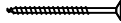

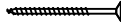
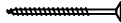
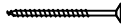





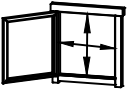
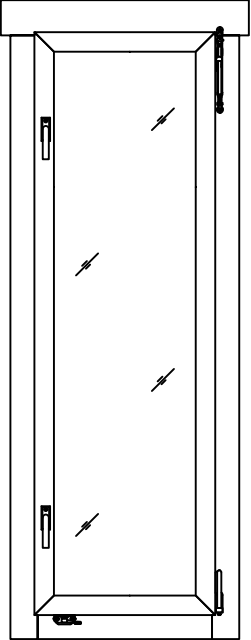
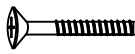

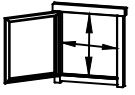
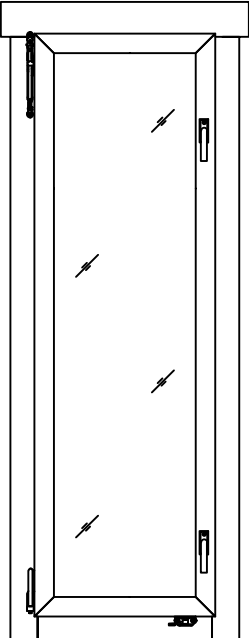
Pos	19.01.2022 Piece list - Stückliste - Liste des pièces - Elementi - Stuklijst - Tükitalabel Art. Nr. 2852300 11/13	Q	P (mm)	L (mm)
001		1	28x57	1377
002		2	28x114	1377
003		27	28x114	421
004		27	28x114	421
005		1	28x114	2596
006		36	28x114	2596
007		2	28x57	1276
008		2	28x57	1276
009		1	28x57	2596
010		1	28x114	1377
011		1	28x114	1448
012		1	28x114	2596
013		1	28x114	1500
IAR4	Foundation - Fundament - Fondation - Fondamenta - Fundering - Immutatud alusraam 	2	45x45	2341
IAR5	Foundation - Fundament - Fondation - Fondamenta - Fundering - Immutatud alusraam 	3	45x45	2296
IAR6	Foundation - Fundament - Fondation - Fondamenta - Fundering - Immutatud alusraam 	1	45x45	2130
IAR2	Foundation - Fundament - Fondation - Fondamenta - Fundering - Immutatud alusraam 	1	45x45	1698
IAR7	Foundation - Fundament - Fondation - Fondamenta - Fundering - Immutatud alusraam 	1	45x45	1680
IAR1	Foundation - Fundament - Fondation - Fondamenta - Fundering - Immutatud alusraam 	1	45x45	1608
IAR3	Foundation - Fundament - Fondation - Fondamenta - Fundering - Immutatud alusraam 	2	45x45	1230
IAR8	Foundation - Fundament - Fondation - Fondamenta - Fundering - Immutatud alusraam 	1	45x45	1185
SR1	Rafter - Dachsparren - Chevron - Trave - Dak spar - Sarikas 	4	44x120	1438
	Floor boards - Fussbodenbretter - Lame de plancher - Pavimento - Vloerhout - Põrandalaud 	26	90x18	2336

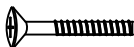
Pos	19.01.2022 Piece list - Stückliste - Liste des pièces - Elementi - Stuklijst - Tükítabel Art. Nr. 2852300	12/13	Q	P (mm)	L (mm)
	Floor fillet - Fussbodenleiste - Corniere de finition du plancher - Finitura per pavimento (battisco pa) - Vloerafwerkljst - Põrandaliist 			18x18	10
TB	Fascia board - Traufbrett - Bandeau de toit - Finitura lati tetto - Gevellijst - Räästalaud 		4	18x90	3000
EL	Roof shield detail - Element - Panneau de toiture - Elementi della - copertura superiore del tetto - Roof element - Dachelement - Panneau de toit prémonté - Componente del tetto - Dakelement - Katusekilp  		4	1461x1411	
EL	Roof shield detail - Element - Panneau de toiture - Elementi della - copertura superiore del tetto - Roof element - Dachelement - Panneau de toit prémonté - Componente del tetto - Dakelement - Katusekilp  		4	1461x1411	
CS	Roof element - Dachelement - Panneau de toit prémonté - Componente del tetto - Dakelement - Katusekilp 		1	1444x722	
KFS-1	Storm protection - Sturmleiste - Latte anti-tempete - Protezione anti vento - Stormverankering / beveliging - Tormikinnitusliist 		5	22x45	2050
DT	Roof support - Dach träger - Support de toit - Supporto del tetto - Dak ondersteuning - Katusetugi 		1	44x44	130
HS12	Screw for fascia boards - Schrauben für traufbretter - Vis pour fixation bandeau de toit - Viti x striscia del tetto - Schroef voor gevellijst - Kruvi räästalauale 		28	4x40	
HS13	Screw for triangular fixing - Montagschraube für dreieckige - Vis d'assemblage pour triangle - Vite per fissaggio triangolare - Schroef voor driehoekig afdekljst - Kruvi kolmnurga monteermiseks seinale 		10	4x60	
HS13	Screw for wall details - Schraube für wand details - Vis pour mur details - Viti per elementi della porta - Schroef voor wand details - Kruvi seinadetailile 		4	4x60	
HS18	Screw for fixing roof elements - Schraube für befestigung dachelementen - Vis de fixation des panneaux de toit - Vite per fissare gli elementi del tetto - Schroef voor bevestiging dakelement - Kruvi kilpide kinnitamiseks seinaga 		48	5x120	
HS18	Screw for rafter - Schrauben für dachsparren - Vis pour chevron - Vite per trave - Schroef voor dakspar - Kruvi sarikatele 		12	5x120	
HS16	Screw for 1. wall beam - Schraube für 1. bohlenreihe - Vis de fixations 1ere rangée de madriers avec poutrelles de fondations - Vite fissaggio alle fondamenta - Schroef voor 1 wandbalk - Kruvi pooltauale 		4	5x90	
HS16	Screw for foundation - Schrauben zur befestigung fundament - Vis de fixations des poutrelles de fondations - Viti x fondamenta - Schroef voor fundering - Kruvi alusraamile 		23	5x90	
HS16	Screw for wall details - Schraube für wand details - Vis pour mur details - Viti per elementi della porta - Schroef voor wand details - Kruvi seinadetailidele 		2	5x90	
HS21	Screw for fixing roof elements - Schraube für befestigung - dachelementen - Vis de fixation des panneaux de toit - Vite per fissare gli elementi del tetto - Schroef voor bevestiging dakelement - Kruvi kilpide montaapiks 		120	6x80	
NF2	Zn nail for floor fillet - Zn nägel für fussbodenleiste - Pointe pour corniere de finition du plancher - Chiodi x fissaggio pavimento - Spijker(nagel) voor vloer afdekljst - Nael põrandaliistule 		19	1.4x40	
SH28	Hammer block - Schlagholz - Calle de frappe - Blocco di legno da usare come cuscinetto quando si usa il martello - Slagklos - Löögiklots 		1		

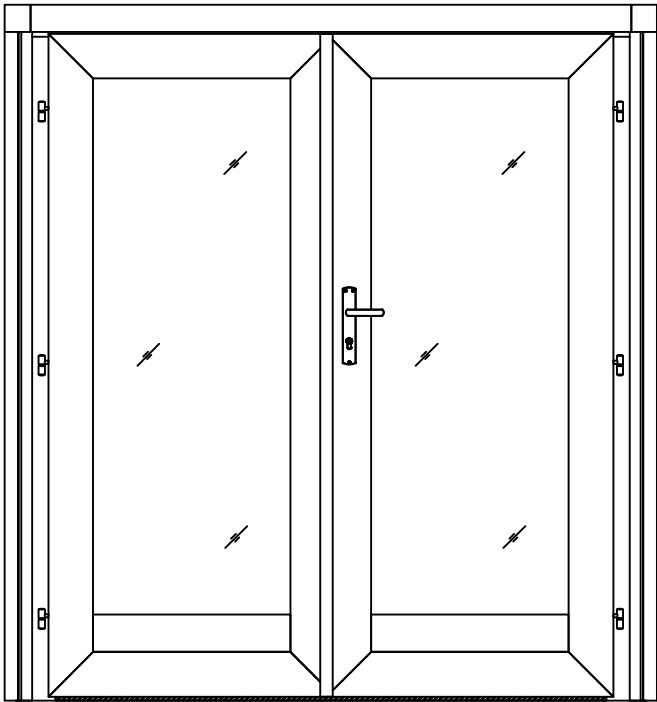
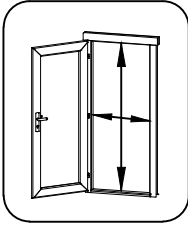

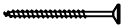
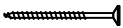
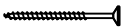
Pos	10.12.2021 Piece list - Stückliste - Liste des pièces - Elementi - Stuklijst - Tükítabel 525x1560 AK.1.100.SSP.j SGC	1/1	Q	P (mm)	L (mm)
	<p data-bbox="260 152 1284 183">Glass size - Glasgröße - Taille de la vitre - Misura del vetro - Glas afmeting - Klaasi mõõt: 381x1416 mm</p> <div data-bbox="1337 152 1524 331" style="border: 1px solid black; border-radius: 10px; padding: 5px; display: inline-block;">  </div> <p data-bbox="1364 347 1492 376" style="text-align: center;">425x1460 mm</p> <div data-bbox="730 470 981 1108" style="text-align: center;">  </div>				
FS1	<p data-bbox="260 2042 1021 2101">Window handle fittings - Fenstergriff - Poignee de fenetre - Maniglia c/ferramenta - Raamhendel -/grendel -/klink - Aknalink</p>		2		
FSP	<p data-bbox="260 2123 1101 2199">Bolt for window handle fittings - Bolzen für fenstergriff beschlag - Vis pour fixation poignee de fenetre - Bullone x apertura manuale finestra - Schroef voor raamhendel - Akna käepideme polt</p>		4		

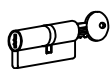
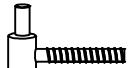
Pos	10.12.2021 Piece list - Stückliste - Liste des pièces - Elementi - Stuklijst - Tükítabel 525x1560 AK.1.100.SSV.j SGC	1/1	Q	P (mm)	L (mm)
	<p data-bbox="260 152 1284 183">Glass size - Glasgröße - Taille de la vitre - Misura del vetro - Glas afmeting - Klaasi mõõt: 381x1416 mm</p> <div data-bbox="1337 152 1522 327" style="border: 1px solid black; border-radius: 10px; padding: 5px; display: inline-block;">  </div> <p data-bbox="1362 344 1497 376">425x1460 mm</p> <div data-bbox="730 434 979 1070" style="text-align: center;">  </div>				
FS1	<p data-bbox="260 2042 1021 2096">Window handle fittings - Fenstergriff - Poignee de fenetre - Maniglia c/ferramenta - Raamhendel -/grendel -/klink - Aknalink</p>			2	
FSP	<p data-bbox="260 2119 1101 2195">Bolt for window handle fittings - Bolzen für fenstergriff beschlag - Vis pour fixation poignee de fenetre - Bullone x apertura manuale finestra - Schroef voor raamhendel - Akna käepideme polt</p>			4	

Pos	07.12.2021	Piece list - Stückliste - Liste des pièces - Elementi - Stuklijst - Tükitalabel 14.94x1736 TUK.1.100.SVP.MM5c SGC	1/1	Q	P (mm)	L (mm)
		Glass size - Glasgröße - Taille de la vitre - Misura del vetro - Glas afmeting - Klaasi mõõt: 524x1397 mm				
		  <p>1418x1679 mm</p>				
HS3	Screw for door fillet - Schraube zur Befestigung Türleiste - Vis pour fixation baguette d'arrêt de porte - Viti per massellino della porta - Schroef voor deurlijst - Krugi ukse kokkuvältsiliistule		5	3x30		
HS22	Screw for fixing door to the wall - Schraube zur Befestigung Tür - zarge mit wand - Vis de fixation partie basse dormant de porte au 1er rang de madrier - Viti per fissare la porta alla parete - Schroef voor bevestiging deur naar wand - Krugi ukseleugi kinnitamiseks seinale		2	3.5x50		
HS45	Screw for covering moulding - Schrauben für deckungsprofil - Vis de fixation profils horizontaux haut inférieur et extérieur d'encadrement de porte - Vite per cornice di copertura - Schroef voor afdekprofiel - Krugi piirdelauale		26	4x40		
HS41	Screw for door jamb - Schraube für Türrahmen - Vis de fixation partie haute avec montants du cadre de porte - Viti x fissaggio montanti porte - Schroef voor deurkozijn - Krugi ukse lengile		4	5x90		
HS59	Screw for doorstep - Schrauben für swelle - Vis pour fixation barre de seuil - Vite per soglia della porta - Schroef voor deurdorpel - Krugi lävepakule		3	4.5x65		
TL4	Door handle fittings - Türgriff - Poignée de porte - Maniglie - Deurhendel / klink - Ukse käepide		1			
TL5	Set of door lock covers - Schlossblenden - Set de garnitures de porte - Copertura serrature - Slot sluitplaat set - Ukse lukuplaat		1			
	Cylinder lock - Zylinderschloss - Barillet de porte - Serratura - Cylinder slot - Ukse lukusüdamik		1	30x35		
	Male bolt hinge for door - Türband - Partie male de paumelle de porte - Cerniera anube x porta - Scharnier bout - Ukse polthing isane		6			
	Striker for barrel bolt - Hülse für Grendelriegel - Gache au sol du targette - Boccola per fermo della porta - Huls voor vergrendelingsschuif - Vasturaud ukse servariivile		2			



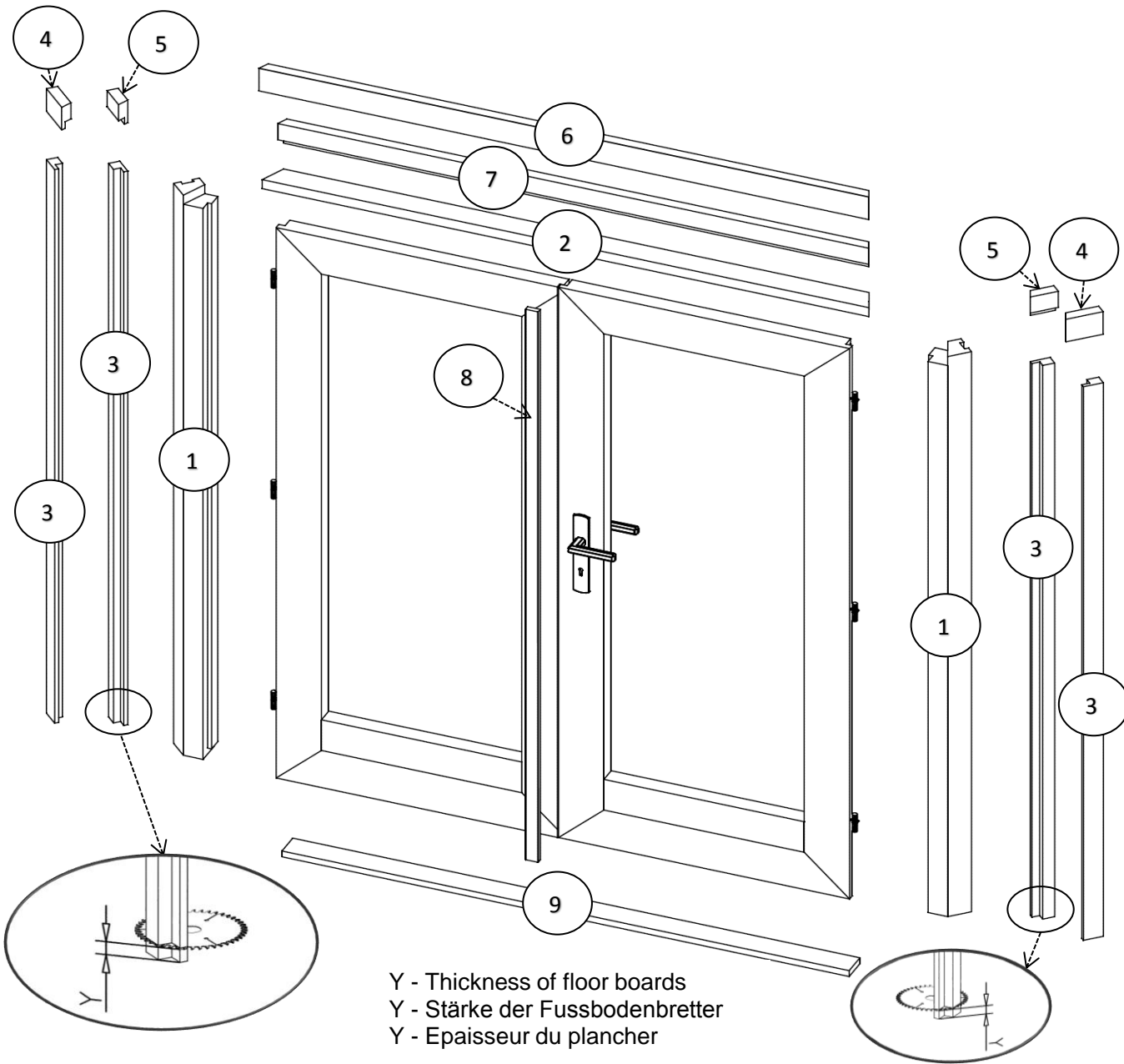

Allgemeine Montageanleitung - General assembly instructions - Instructions générales de montage

Pos	Piece list - Stückliste - Liste des pièces	Q.	P (mm)	L (mm)
1		2	65x60	1736
2		1	65x38	1538
3		4	28x50	1721
4		2	28x70	94
5		2	28x70	71
6		1	28x70	1546
7		1	28x70	1499
8		1	13x32	1706
9		1	18x65	1438

