

Assembly, installation and maintenance manual

Montage-, Aufbau- und Wartungsanleitung • Assemblage, manuel de montage et d'entretien • Montaje, instalación y mantenimiento • Manuale di montaggio, installazione e manutenzione • Monterings- og vedlikeholdsmanual • Monterings-, installations- och underhållsmanual • Kokoamis-, asennus- ja huolto-ohje • Vejledning for montering og vedligehold • Handleiding voor montage, installatie en onderhoud • Manual de montagem, instalação e manutenção • Návod k montáži, instalaci a údržbě • Instrukcja montażu, instalacji i konserwacji • Surinkimo, montavimo ir priežiūros vadovas • Montāžas, uzstādīšanas un apkopes rokasgrāmata • Руководство по сборке и обслуживанию • Montaaži-, paigaldus- ja säilitamise juhend



Pavilion **PA28-2929-2**

Treatment options, Item code

• Behandlungsoptionen, Artikel-Code • Traitement options, code de l'article • Opciones de tratamiento, código del artículo • Opzioni di trattamento, codice articolo • Behandlingsalternativer, artikkelnummer • Behandlingsalternativ, varukod • Käsittelevaihtoehdot, yksikön koodi • Behandlingsmuligheder, artikel nummer • Behandlingsopties, artikelnummer • Opções de tratamento, código do artigo • Povrchové úpravy, kód položky • Możliwości leczenia, kod produktu • Apdorojimo variantai, prekės kodas • Apstrādes iespējas, artikula kods • Варианты обработки, код изделия • Tõõtlusvõimalused, tootekood

NO 103744

<p>Factory inspection by • Werkskontrolle durch • Contrôle à partir de l'usine par • Inspector de fábrica • Collaudato da • Fabrikkkontroll utført av • Fabriksbesiktigat av • Tehtaan tarkastaja • Fabriks Kontrol udført af • Fabrikscontrole door • Inspeção de fábrica, por: • Zkontrolováno ve výrobním závodě • Kontrola fabryczna do • Apžiūra gamykloje atliko • Rūpnīcas pārbaudi veicis • Заводской контроль • Tehase kontroll teostatud:</p> <p>.....</p>	<p>Date • Datum • Date • Fecha • Data • Dato • Datum • Päiväys • Dato • Datum • Data • Datum • Data • Datums • Data • Дата • Kuupäev:</p> <hr/> <p>Pack number • Pack Nr. • Packet n° • Bulto N° • Pacco N. • Serienr • Produktionsnummer • Pakettinro • Pakke nr. • Pak nr. • Número de embalagem • Číslo balení • Numer opakowania • Pakuotės numeris • Iepakojuma numurs • Упаковочный номер • Pakinumber:</p>
---	---

Inspection Certificate

Kontrollschein • Bulletin de contrôle • Certificado de control • Certificato di controllo • Kontrollskjema • Besiktningsprotokoll • Tarkastustodistus • Kontrol Certifikat • Control Certificaat • Certificado de Inspeção • Kontrolní certifikát • Certyfikat kontrolny • Apžiūros pažyma • Pārbaudes akts • Акт осмотра • Kontrollakt

Art. Nr. PA28-2929-2

Please keep safely!

Bitte gut aufbewahren! • A bien conserver, s.v.p.! • ¡A conservar! • Da conservare! • Ta vare på denne! • Vänligen förvara säkert! • Ole hyvä ja säilytä huolella! • Opbevares sikkert! • Zorgvuldig te bewaren! • Por favor, guarde em segurança! • Prosím, pečlivě uschovejte! • Przechowywać w bezpiecznym miejscu! • Laikykite saugiai! • Lūdzu, glabājiet drošā vietā! • Хранить в надежном месте! • Palun säilitada hoolsalt!

English: The product you have purchased was manufactured in accordance with the high quality norms. The product unit has been carefully inspected and packed. In order to avoid possible problems during the assembly carried out by yourself or the building company of your choice, we recommend that you inspect the delivery for its completeness in accordance with the list of pieces before assembly. This inspection must be carried out within 14 days after delivery to your place. Warranty claims are limited to the exchange of defective materials. Defective product parts, which have already been used or painted, are excluded from being replaced. All further claims are excluded! In cases of complaints, please pay attention to the following procedures: Please present this inspection certificate along with the sales receipt to your place of purchase. Only in cases where these documents are presented will the complaint be dealt with quickly and without complications.

Deutsch: Der von Ihnen gekaufte Artikel wurde nach der hohen Qualitätsnorm gefertigt. Der Bausatz wurde sorgfältig geprüft und verpackt. Um etwaige auftretende Probleme während des Aufbaus durch Sie oder Ihre Aufbaufirma zu vermeiden, kontrollieren Sie bitte die Lieferung auf Vollständigkeit laut Stückliste vor dem Aufbau. Diese Kontrolle muss innerhalb 14 Tagen nach Anlieferung bei Ihnen erfolgen. Ansprüche auf Gewährleistung beschränken sich auf den Austausch von fehlerhaftem Material. Fehlerhafte Bauteile, die bereits verbaut oder gestrichen wurden, sind vom Umtausch ausgeschlossen. Alle weiteren Ansprüche sind ausgeschlossen! Sollte es zu einer Beanstandung kommen, beachten Sie folgende Vorgehensweise: Legen Sie Ihrem Fachhändler diesen Kontrollschein zusammen mit dem Einkaufsbeleg vor. Nur bei Vorlage dieser Unterlagen ist eine schnelle und problemlose Bearbeitung Ihrer Beanstandung möglich.

Français: Le produit que vous venez d'acheter a été fabriqué en respectant de hautes normes de qualité. Ce produit a été testé et emballé avec soin. Afin d'éviter des problèmes éventuels pendant la construction par vous-même ou par la société de construction mandatée, nous vous prions de bien vouloir vérifier que toutes les pièces ont été fournies selon la liste des pièces avant que vous ne commenciez la construction. Il vous incombe de faire ce contrôle dans les 14 jours après la fourniture. Les revendications en dédommagement se limitent à l'échange de matériel défectueux. Les pièces défectueuses, déjà construites ou peintes, ne font pas l'objet de l'échange. Toutes les revendications ultérieures ne sont pas prises en compte ! En cas d'une réclamation, veuillez respecter le déroulement suivant : il vous faudra présenter à votre commerçant agréé ce bulletin de contrôle avec le récépissé de l'achat. Ce ne sera que moyennant présentation de ces documents qu'un traitement rapide et sans problème de votre réclamation sera possible!

Español: El producto que ha adquirido ha sido fabricada de acuerdo con normas de alta calidad. Las piezas del producto han sido cuidadosamente inspeccionadas y embaladas. Con el fin de evitar posibles problemas durante el montaje, hecho por usted o por la empresa de construcción de su elección, le recomendamos revisar el paquete entregado, con la lista de piezas, antes de armar el producto. Haga la revisión dentro de 14 días después de recibir el paquete. La garantía se limita a reemplazar las piezas defectuosas. No se reemplazarán las partes defectuosas que ya hayan sido utilizadas o pintadas. ¡No se aceptan otras reclamaciones! En casos de queja, por favor, presente este certificado junto con la factura en el lugar donde hizo la compra. Sólo presentando estos documentos podremos resolver su problema rápidamente y sin complicaciones.

Italiano: Il prodotto che avete acquistato è stata prodotta secondo la norma di alta qualità. Il kit è stato controllato ed imballato con cura. Per evitare eventuali inconvenienti durante il montaggio, si prega di verificare, prima del montaggio, la completezza della fornitura in base alla distinta dei pezzi. Tale verifica deve essere effettuata entro 14 giorni dalla consegna. Eventuali diritti di garanzia si limitano alla sostituzione di materiale difettoso. Gli elementi difettosi già montati o verniciati sono esclusi dal diritto alla sostituzione. Ogni altro diritto resta escluso! In caso di reclamazione, procedere nel modo seguente: presentare questo certificato di controllo unitamente alla prova d'acquisto al rivenditore. Solo in questo modo la Sua reclamazione potrà essere evasa rapidamente e senza problemi.











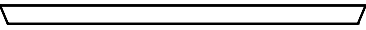
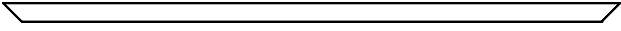
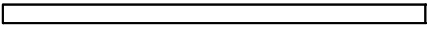
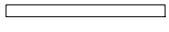

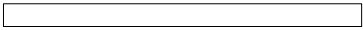

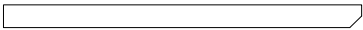
Norsk: Produktet du har kjøpt, ble produsert i henhold til høye kvalitetskrav. Produktet har blitt kontrollert nøye og deretter omhyggelig pakket. For å unngå mulige problemer under monteringen, uansett om du gjør det selv eller får en godkjent håndverker til å gjøre det, anbefaler vi at du kontrollerer leveransen mot delelisten for å se om alle delene er inkludert. Denne kontrollen må gjøres innen 14 dager etter at delene ble levert til din adresse. Garantikrav begrenser seg til bytte av defekte deler. Defekte elementer som allerede har blitt brukt eller malt/beiset/limt, vil ikke bli erstattet. Alle andre krav er utelukket! Dersom du har en reklamasjon, vennligst gjør som følger: Lever dette kontrollskjema med kvitteringen til salgsstedet. Bare når du har med disse dokumentene kan klagen behandles raskt og uten komplikasjoner.

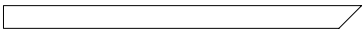
Svenska: Produkten du köpt har tillverkats i enlighet med de högsta kvalitetsstandarderna. Produktens delar har noggrant besiktigats och förpackats. För att undvika eventuella problem under monteringen som du utför själv eller låter en hantverkare att utföra, rekommenderar vi att du, innan monteringen påbörjas, besiktigar leveransen för att säkerställa att den är komplett enligt förteckningen över ingående delar. Denna besiktning måste utföras inom 14 dagar efter att du tagit emot leveransen. Garantianspråk är begränsade till ersättning av defekt material. Defekta produkt delar, vilka redan har använts eller målats, ersätts inte. Alla vidare anspråk avvisas! I händelse av reklamationer, vänligen uppmärksamma följande: uppvisa detta besiktningsprotokoll tillsammans med inköpsbeviset till ditt inköpsställe. Endast om dessa dokument uppvisas kan vi garantera att reklamationen behandlas skyndsamt och utan krångel.

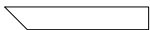







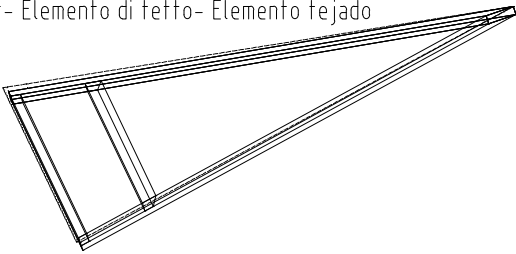
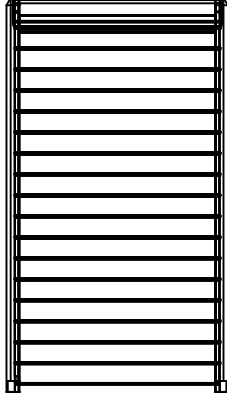
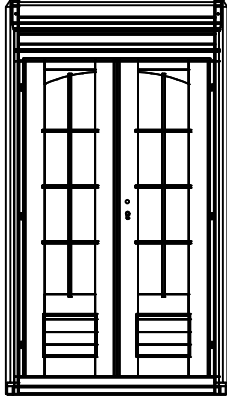
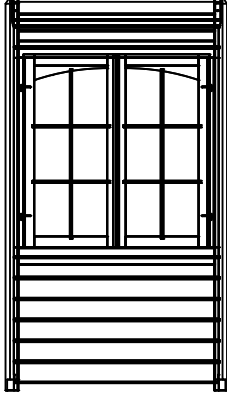
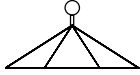

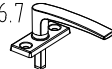

Suomi: Ostamasi tuote on valmistettu korkeita laatuvaatimuksia noudattaen, huolella tarkastettu ja pakattu. Jotta pystytys joko itsesi tai valitsemasi rakennusliikkeen toimesta sujuisi ongelmitta, suosittelimme, että tarkistat toimituksen sisällön osaluettelon avulla ennen kokoamisen aloittamista. Tämä tarkistus tulee tehdä 14 päivän kuluessa toimituksesta. Takuuvaateet rajoittuvat viallisten materiaalien vaihtamiseen. Viallisia osia, joita on jo käytetty ja jotka on maalattu, ei vaihdeta uusiin. Lisävaatimuksia ei huomioida! Mahdollisissa valitustapauksissa toimi seuraavasti: Esitä oheinen tarkastustodistus ja kassakuitti ostopaikassa. Valituksen nopea ja mutkaton käsittely edellyttää näiden asiakirjojen esittämistä.



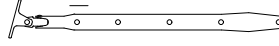





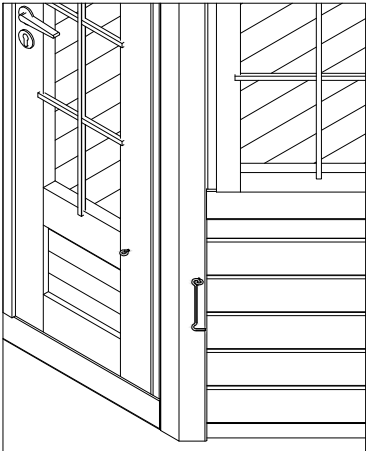

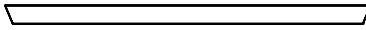
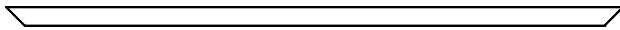
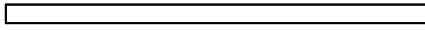
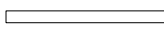

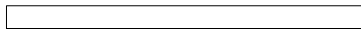



<p>Dansk: Det købte produkt fremstillet i overensstemmelse med de høje kvalitets krav. Produktet er blevet omhyggeligt inspiceret og pakket. For at undgå eventuelle problemer i løbet af monteringen udført af dig selv eller håndværker af dit eget valg, anbefaler vi, at du undersøger leverancen for fuldstændighed i overensstemmelse med listen over dele før samling. Denne inspektion skal foretages inden 14 dage efter levering til din plads. Garantikrav er begrænset til udveksling af defekte materialer. Defekte produkter, som allerede er brugt eller malet, er udelukket fra at blive erstattet. Alle yderligere krav er udelukket! I tilfælde af klager, skal du være opmærksom på følgende procedurer: Venligst præsenterer denne kontrol certifikat sammen med kvitteringen til det sted hvor produktet er købt. Kun i de tilfælde, hvor disse dokumenter er forelagt kan klagen behandles hurtigt og uden komplikationer.</p>
<p>Dutch: Het door U gekochte product werd vervaardigd overeenkomstig hoge kwaliteitsnormen. Het product werd zorgvuldig gecontroleerd en verpakt. Om tijdens de montage, uitgevoerd door Uzelf of een door U gekozen aannemer, problemen te vermijden, raden we U aan, vóór de montage de levering te controleren op volledigheid in overeenstemming met de onderdelenlijst. Deze controle dient te gebeuren binnen 14 dagen na levering bij U thuis. Garantieclaims zijn beperkt tot het vervangen van defecte onderdelen. Defecte onderdelen die al gebruikt of geschilderd zijn, zijn uitgesloten van vervanging. Alle latere claims zijn uitgesloten! In geval van klachten dient u als volgt te handelen: Toon dit controlecertificaat, samen met Uw aankoopbewijs aan Uw verkoper. Alleen wanneer deze documenten getoond worden, zal de klacht snel en zonder complicaties in behandeling worden genomen.</p>
<p>Português: O produto que comprou foi fabricado em conformidade com as normas de alta qualidade. A unidade do produto foi cuidadosamente inspecionada e embalada. Para evitar possíveis problemas durante a montagem realizada por si ou pela empresa de construção à sua escolha, recomendamos que inspecione a entrega na íntegra, em conformidade com a lista de peças antes da montagem. Esta inspeção deve ser realizada no prazo de 14 dias após a entrega. As reclamações de garantia limitam-se à troca de materiais defeituosos. As peças do produto com defeito, que já tenham sido utilizadas ou pintadas, excluem-se da substituição. Excluem-se todas as outras reclamações! Em caso de reclamações, por favor, tome atenção aos seguintes procedimentos: Por favor, apresente este certificado de inspeção, juntamente com o recibo de venda no seu local de compra. Apenas nos casos em que estes documentos sejam apresentados a queixa será tratada com rapidez e sem complicações.</p>
<p>Čeština: Produkt, který jste zakoupil, byl vyroben v souladu s normami stanovujícími vysokou kvalitu. Produkt byl výrobcem pečlivě prohlédnutý a zabalený. Aby se předešlo možným problémům při montáži prováděné svépomocí nebo stavební firmou dle vašeho výběru, doporučujeme vám před montáží zkontrolovat dodávku na úplnost v souladu se seznamem dílů. Tato prohlídka musí být provedena do 14 dnů (!) od doručení do místa určení. Záruční nároky jsou omezeny na výměnu vadných materiálů. Vadné produkty, které již byly použity nebo které jsou již opatřeny nátěrem, nemohou být nahrazeny. Všechny další nároky jsou vyloučeny! V případě reklamace věnujte prosím pozornost tomuto postupu: Předložte svému prodejci tento kontrolní certifikát spolu s prodejním dokladem. Pouze v případě, kdy jsou předloženy oba tyto dokumenty, lze reklamaci řešit rychle a bez komplikací.</p>
<p>Polski: Produkt, który Państwo zakupili, wykonano według najwyższych norm jakości. Elementy konstrukcyjne przed zapakowaniem przeszły dokładną kontrolę jakości. Aby uniknąć problemów podczas samodzielnego montażu, bądź montażu zleconego firmie budowlanej, przed montażem zalecamy sprawdzenie zawartości przesyłki zgodnie z listą części zamieszczonych w zestawie. Kontrola kompletności zestawu należy dokonać w ciągu 14 dni od dostarczenia przesyłki. Reklamacje objęte gwarancją ograniczają się do wymiany wadliwych elementów. Wadliwe elementy, które zostały użyte lub pomalowane nie będą podlegały wymianie ani dalszym reklamacjom. W przypadku potrzeby zgłoszenia reklamacji, prosimy przestrzegać poniższych procedur: prosimy przedłożyć Certyfikat kontrolny wraz z paragonem zakupu i adresem dostawy. Reklamacje będą rozpatrywane wyłącznie po dostarczeniu powyższych dokumentów.</p>
<p>Lietuviškai: Produktas, kurį įsigijote, pagamintas pagal aukštos kokybės standartus. Produkto blokas, kurį reikia surinkti, buvo atidžiai patikrintas ir supakuotas. Siekiant išvengti galimų problemų surenkant produktą patiems arba pasirinkus tam norimą statybos bendrovę, prieš surenkant rekomenduojame patikrinti pristatymo komplektaciją pagal dalių sąrašą. Ši patikra turi būti atlikta per 14 dienų nuo pristatymo į jūsų namus vietą. Garantinės sąlygos taikomos tik brokuotoms dalims. Brokuotos produkto dalys, kurios buvo panaudotos arba nudažytos, nebekeičiamos. Visos kitos pretenzijos nesvarstomos! Jei teikiate pretenziją, atkreipkite dėmesį į šias procedūras: į produkto įsigijimo vietą turite pristatyti apžiūros pažymėjimą bei pirkimo kvitą. Tik tais atvejais, kai pristatomi minėti dokumentai, pretenzija gali būti nagrinėjama greitai ir be komplikacijų.</p>
<p>Latviešu: Produkts, kuru esat iegādājies, ir ražota saskaņā ar augstām kvalitātes normām. Šī produkta vienība ir rūpīgi pārbaudīta un iepakota. Lai izvairītos no iespējamiem sarežģījumiem montāžas laikā, kuru veicat jūs pats vai jūsu izvēlēts celtniecības uzņēmums, pirms montāžas iesakām pārbaudīt, vai piegādātajam izstrādājumam nekas netrūkst, izmantojot detaļu sarakstu. Šī pārbaude jāveic 14 dienu laikā pēc piegādāšanas. Garantija paredz tikai defektīvo materiālu apmaiņu. Defektīvas produkta detaļas, kuras jau ir izmantotas vai nokrāsotas, netiks mainītas. Visas turpmākās pretenzijas tiks noraidītas! Sūdzību gadījumā, lūdzu, ievērojiet šādu kārtību: lūdzu, uzrādiet šo pārbaudes aktu kopā ar pirkuma čeku izstrādājuma iegādāšanās vietā. Sūdzība tiks atrisināta ātri un bez sarežģījumiem tikai tad, ja tiks uzrādīti šie dokumenti.</p>
<p>Русский: Приобретенное вами изделие изготовлено по высоким стандартам качества. Изделие внимательно проверено и упаковано. Во избежание возможных проблем в процессе сборки, выполняемой самостоятельно или привлеченной вами строительной компанией, рекомендуем перед сборкой проверить комплектность поставки по комплектвочной ведомости. Такую проверку следует провести в течение 14 дней после доставки товара. Претензии по гарантии ограничиваются заменой дефектных материалов. Дефектные части изделия, которые уже были использованы или окрашены, замене не подлежат. Все прочие претензии не принимаются! Порядок подачи претензии: Претензия подается с настоящим актом осмотра и товарным чеком по месту покупки товара. Только при наличии всех указанных документов претензия будет рассмотрена быстро и без сложностей.</p>
<p>Eesti: Ostetud toode on toodetud vastavuses kõrgete kvaliteedi normidega. Toote ühik on hoolikalt kontrollitud ja pakendatud. Et vältida võimalikke probleeme paigaldamisel, mida teostate ise või teostab teie poolt valitud paigaldusettevõte, soovime enne paigaldama asumist kontrollida toote kompleksust detailide nimekirja alusel, mille leiате kaasas olevast juhendist. See kontroll tuleb teostada 14 päeva jooksul pärast tarnet. Garantii alla kuuluvad kaebused on piiratud defektsete detailide välja vahetamisega. Defektsed detailid, mida on juba kasutatud või värvitud, ei kuulu garantiikorras välja vahetamisele. Kõik edasised kaebused on välistatud! Kaebuste korral palun pöörake tähelepanu järgnevale: palun hoidke see kontrollakt koos müügiarvega alles. Ainult nende dokumentide esitamisel lahendatakse kaebused kiiresti ja ilma komplikatsioonideta.</p>

The producer shall have the right to make technical changes to the product. • Technische Änderungen vorbehalten. • Le producteur réserve le droit d'effectuer des modifications techniques au produit. • Reservado el derecho a modificaciones técnicas. • Il produttore mantiene il diritto di apportare modifiche tecniche al prodotto. • Producent forbeholder seg retten til å endre tekniske egenskaper ved produktet. • Tillverkaren har rätt att utföra tekniska förändringar för produkten. • Valmistaja pidättää oikeuden tehdä tuoteeseen teknisiä muutoksia. • Producenten har ret til at foretage tekniske ændringer ved produktet. • Alle rechten en technische wijzigingen voorbehouden. • O fabricante reserva-se o direito de realizar alterações técnicas ao produto. • Výrobce je oprávněn provádět technické úpravy produktu. • Producent zastrzega sobie prawo do dokonywania zmian technicznych produktu. • Gamintojas turi teisę atlikti techninius gaminio pakeitimus. • Ražotājs patur tiesības veikt tehniskas produkta izmaiņas. • Производитель оставляет за собой право вносить в изделие технические изменения. • Tootja jätab endale õiguse muuta toote tehnilisi omadusi.

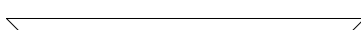







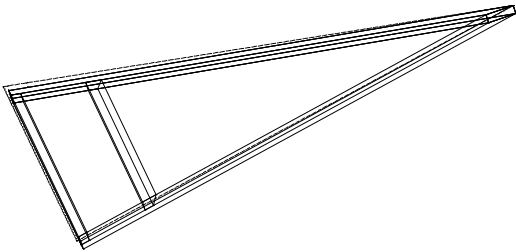
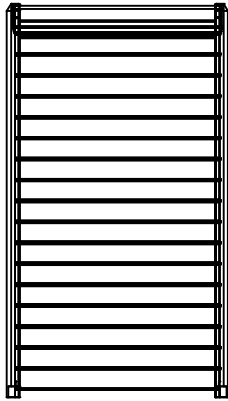
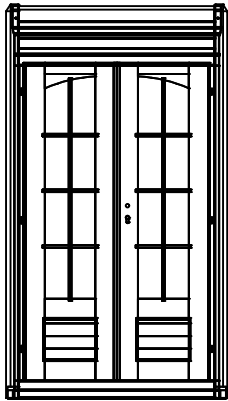
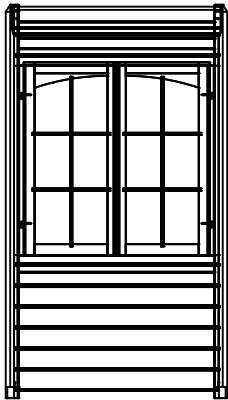
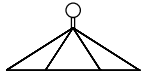

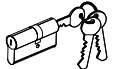
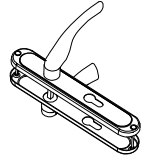
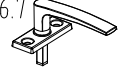

Pos	SPECIFICATION - STÜCKLISTE - NOMENCLATURE - ELEMENTI "PAP28-2929"/"PA28-2929-1"	Pcs	Profile (mm)	Length (mm)
1	Foundation- Fundament- Fondation- Fondazione- Vigas de cimentación 	8	45x70	1185
2	Foundation- Fundament- Fondation- Fondazione- Vigas de cimentación 	2	45x70	1994
3	Foundation- Fundament- Fondation- Fondazione- Vigas de cimentación 	6	45x70	1360
4	Foundation- Fundament- Fondation- Fondazione- Vigas de cimentación 	3	45x45	600
5	Floor board- Fussbodenbrett- Madrier du plancher - Tavola pavimento- Tabla de suelo 			
5.1		13	19x89	1959
5.2		13	19x89	902
5.3		2	19x89	1959
5.4		2	19x89	902
5.5		2	19x89	1884
5.6		2	19x89	827
5.7		2	19x89	1795
5.8		2	19x89	738
5.9		2	19x89	2355
5.10		2	19x89	2177
5.11		2	19x89	1999
5.12		2	19x89	1821
5.13		2	19x89	1643
5.14		2	19x89	1465
5.15		2	19x89	1287
6	Fitting slat- Montagebrett- Tableau de montage- Tavola di montaggio- Tabla de montaje 	3	6x12	1200
7	Floor beading- Fussbodenleiste- Baguette du plancher - Listello pavimento- Listón de suelo 	7	19x40	1075
8	Wall batten- Wandleiste- Baguette du mur - Listello di muro- Liston de pared 	8+8	19x65	2056
9	Roof support brace- Dachstützleiste- Baguette de support de toit - Listello supporto tetto- Listón soporte tejado 	8	19x95	1075
10	Eave edging- Dachrandbrett- Madrier en bordure du toit - Tavola bordo tetto- Tabla de valadizo 	8	19x95	1482

Pos	SPECIFICATION - STÜCKLISTE - NOMENCLATURE - ELEMENTI "PAP28-2929"/"PA28-2929-1"	Pcs	Profile (mm)	Length (mm)
11	Roof element- Dachelement- Panneau de toit- Elemento di tetto- Elemento tejado 	8	61x1441	2185
12	Wall element- Wandelement- Panneau du mur- Elemento di muro- Elemento pared 	Veronica 2_6.7 5 Veronica 4_6.7 3	55x1196	2091
13	Door element- Türelement- Panneau du porte- Elemento di porta- Elemento puerta 	1	55x1196	2091
14	Window element- Fensterelement- Panneau de la fenêtre- Elemento di finestra- Elemento ventana 	Veronica 2_6.7 2 Veronica 4_6.7 4	55x1196	2091
15	Roof cap- Dachkappe- Finition métallique- Finitura di tetto- Caballete de tejado QK08-2 	1		
16	Wind brace- Windbrett- Madrier contre le vent- Tavola vento- Tabla contra el viento Veronica 2_6.7 5 Veronica 4_6.7 9	5 9	19x70	1075

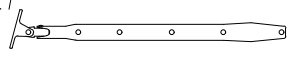
Pos	SPECIFICATION - STÜCKLISTE - NOMENCLATURE - ELEMENTI "PAP28-2929"/"PA28-2929-1"	Pcs	Profile (mm)	Length (mm)
17	Fixing kit- Befestigungsset- Moyens de fixation- Materiale di fissaggio- Kit de fijación	1		
QULS130x 40	Cylinder- Zylinderschloss- Serrure a mortaiser- Serratura a cilindro- Bombin- 30.40	1		
QLIU KAPal	Door fittings- Türbeschlag- Ferrure- Ferramenta porta- Manilla puerta	1		
QLIA	Window fittings- Fenstergriff- Poigne de la fenêtre- Maniglia finestra- Manilla (ventana)	Veronica 2_6.7 / Veronica 4_6.7 2/4		
QKRPP4 _5x50Zn	Screw- Schraube- Vis- Vite- Tornillo- 4.5x50mm		210	
QKRPP4 _5x70Zn	Screw- Schraube- Vis- Vite- Tornillo- 4.5x70mm		68	
QKRPP5x 90Zn	Screw- Schraube- Vis- Vite- Tornillo- 5x90mm		40	
QKRPP6x 120Zn	Screw- Schraube- Vis- Vite- Tornillo- 6x120mm		22	
QNA1_4x 40Me	Nail- Nagel- Clou- Chiodo- Clavo- 1.4x40mm		28	
QNA2_2 x50Zn	Nail- Nagel- Clou- Chiodo- Clavo- 2.5x50mm		300	
QAF240Zn	Window stop- Fensterfeststelle- Crémaillere- Fissativo finestra- Fijador de ventana- QFK240Zn	Veronica 2_6.7 / Veronica 4_6.7 	4/8	
QRV120	Keeper- Schllessblech- Tole- Lamiera- Aldaba de candado	Veronica 2_6.7 / Veronica 4_6.7 	5/9	
QKRPP2 _5x16kZ n	Screw- Schraube- Vis- Vite- Tornillo- 2.5x16mm	Veronica 2_6.7 / Veronica 4_6.7 	12/20	
QKRPP3x 20Zn	Screw- Schraube- Vis- Vite- Tornillo- 3x20mm	Veronica 2_6.7 / Veronica 4_6.7 	48/72	
QT15_5x 9PR-2	Seal- Gummidichtung- Joint d'isolation- Guarnizione- Burlete- QT15_5x9PR	Veronica 2_6.7 / Veronica 4_6.7 	1/1	8000
QT15_5x 9PR-2	Seal- Gummidichtung- Joint d'isolation- Guarnizione- Burlete- QT15_5x9PR	Veronica 2_6.7 / Veronica 4_6.7 	2/4	6000
QHA150Z n	Hook- Haken- Crochet- Ganzio- Pestillo QHA150Z n	 	2	Door+Wall

Pos	SPECIFIKATION - MÄÄRITYS "PAP28-2929"/"PA28-2929-1"	Pcs	Profile (mm)	Length (mm)
1	Grund-Perustus 	8	45x70	1185
2	Grund- Perustus 	2	45x70	1994
3	Grund- Perustus 	6	45x70	1360
4	Grund- Perustus 	3	45x45	600
5	Golvbräda- Lattialauta 			
5.1		13	19x89	1959
5.2		13	19x89	902
5.3		2	19x89	1959
5.4		2	19x89	902
5.5		2	19x89	1884
5.6		2	19x89	827
5.7		2	19x89	1795
5.8		2	19x89	738
5.9		2	19x89	2355
5.10		2	19x89	2177
5.11		2	19x89	1999
5.12		2	19x89	1821
5.13		2	19x89	1643
5.14		2	19x89	1465
5.15		2	19x89	1287
6	Passbit- Asennuslista 	3	6x12	1200
7	Golvllster- Lattialista 	7	19x40	1075
8	Spikläkt- Seinärima 	8+8	19x65	2056
9	Takstol- Katon jäykistystuki 	8	19x95	1075
10	Takfotsbräda- Räystään reuna 	8	19x95	1482

Pos	SPECIFIKATION - MÄÄRITYS "PAP28-2929"/"PA28-2929-1"	Pcs	Profile (mm)	Length (mm)
11	Takelement- Kattoelementti 	8	61x1441	2185
12	Väggelement- Seinäelementti 	Veronica 2_6.7 Veronica 4_6.7 5 3	55x1196	2091
13	Dörrelement- Ovielementti 	1	55x1196	2091
14	Fönsterelement- Ikkunaelementti 	Veronica 2_6.7 Veronica 4_6.7 2 4	55x1196	2091
15	Takåstäckning- Tuuletusputken hatt- QK08-2 	1		
16	Vindskiva- Tuulside Veronica 2_6.7 Veronica 4_6.7	5 9	19x70	1075

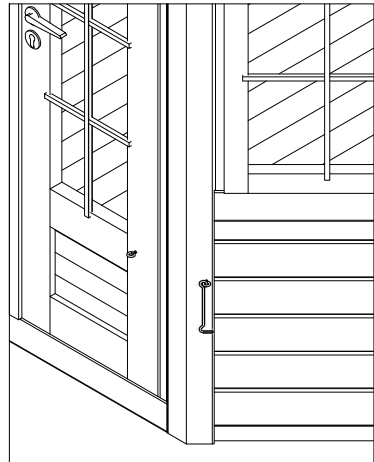
Pos	SPECIFIKATION - MÄÄRITYS "PAP28-2929"/"PA28-2929-1"		Pcs	Profile (mm)	Length (mm)
17	Infästningssats- Kiinnityssarja		1		
QULSI30x 40	Cylinder- Sylinteri		1		
QLIU KAPal	Dörrbeslag- Ovihelat		1		
QLIA	Fönsterbeslag- Ikkunahelat	Veronica 2_6.7 / Veronica 4_6.7 	2/4		
QKRPP4 _5x50Zn	Skruv- Ruuvi 4.5x50mm		210		
QKRPP4 _5x70Zn	Skruv- Ruuvi 4.5x70mm		68		
QKRPP5x 90Zn	Skruv- Ruuvi 5x90mm		40		
QKRPP6x 120Zn	Skruv- Ruuvi 6x120mm		22		
QNA1_4x 40Me	Spik- Naula 1.4x40mm		28		
QNA2_2 x50Zn	Spik- Naula 2.5x50mm		300		
QAF240Zn	Fönsterstopp- Ikkunan rajoitin	Veronica 2_6.7 / Veronica 4_6.7 	4/8		
QRV120	Hållare- Pidike	Veronica 2_6.7 / Veronica 4_6.7 	5/9		
QKRPP2 _5x16kZ n	Skruv- Ruuvi 2.5x16mm	Veronica 2_6.7 / Veronica 4_6.7 	12/20		
QKRPP3x 20Zn	Skruv- Ruuvi 3x20mm	Veronica 2_6.7 / Veronica 4_6.7 	48/72		
QT15_5x 9PR-2	Tiiviste- Tätning- QT15_5x9PR	Veronica 2_6.7 / Veronica 4_6.7 	1/1		8000
QT15_5x 9PR-2	Tiiviste- Tätning- QT15_5x9PR	Veronica 2_6.7 / Veronica 4_6.7 	2/4		6000
QHA150Z n	Krok- Koukku	 	2	Dörr+Vägg Ovi+Seinä	

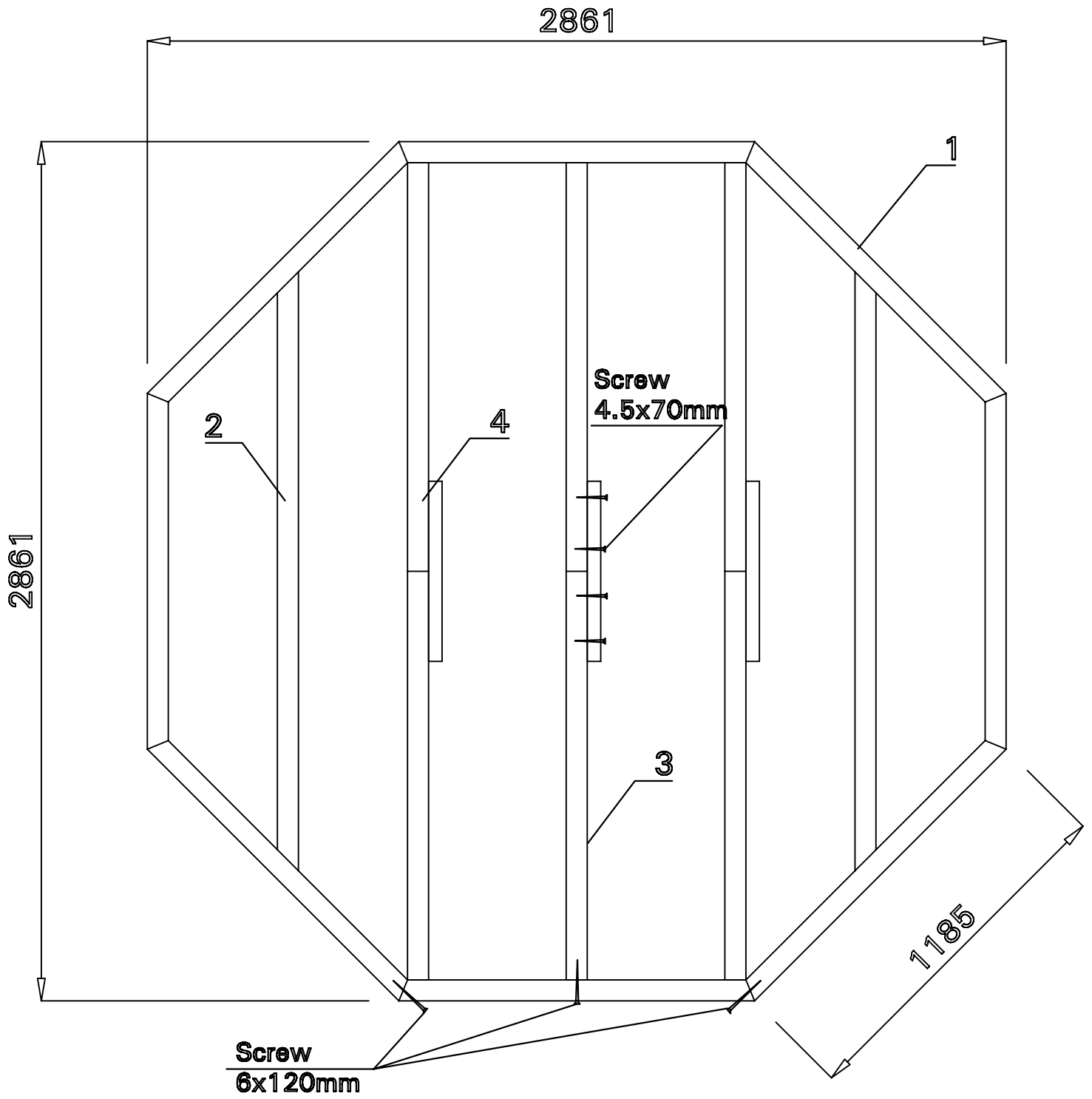

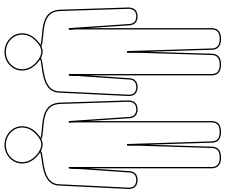

Ø4

Ø3

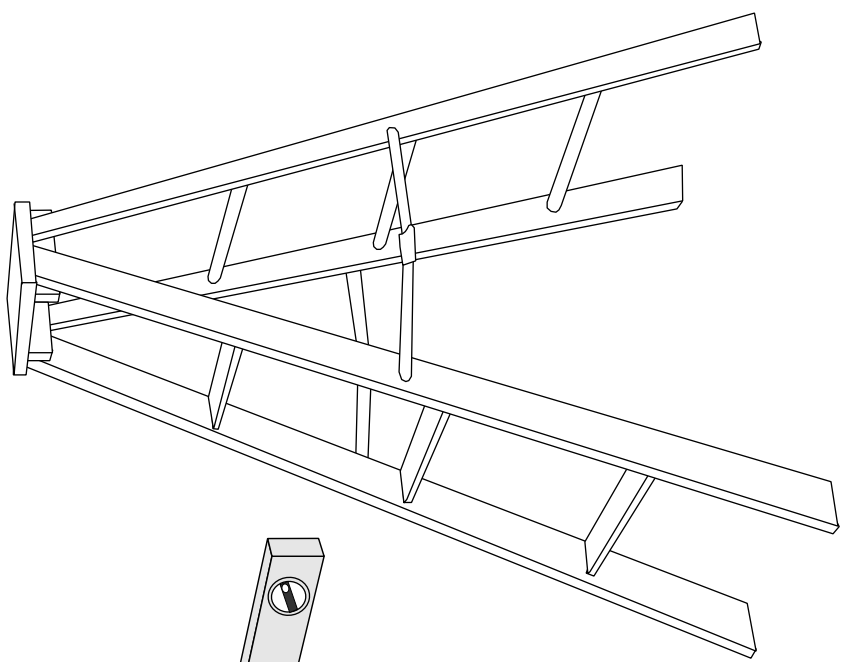
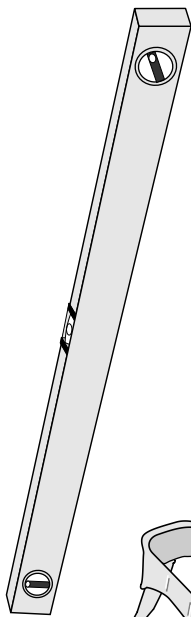
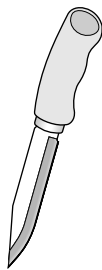
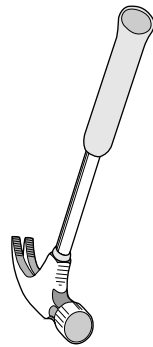
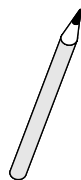
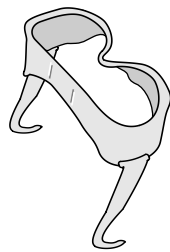
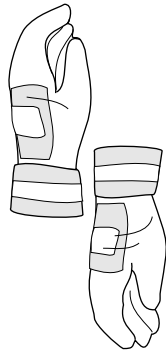
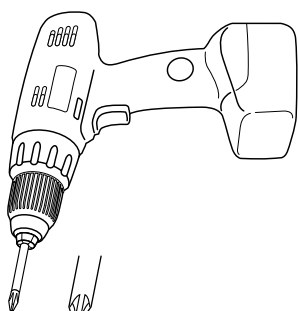
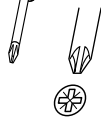

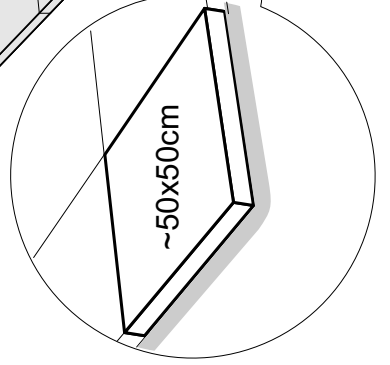
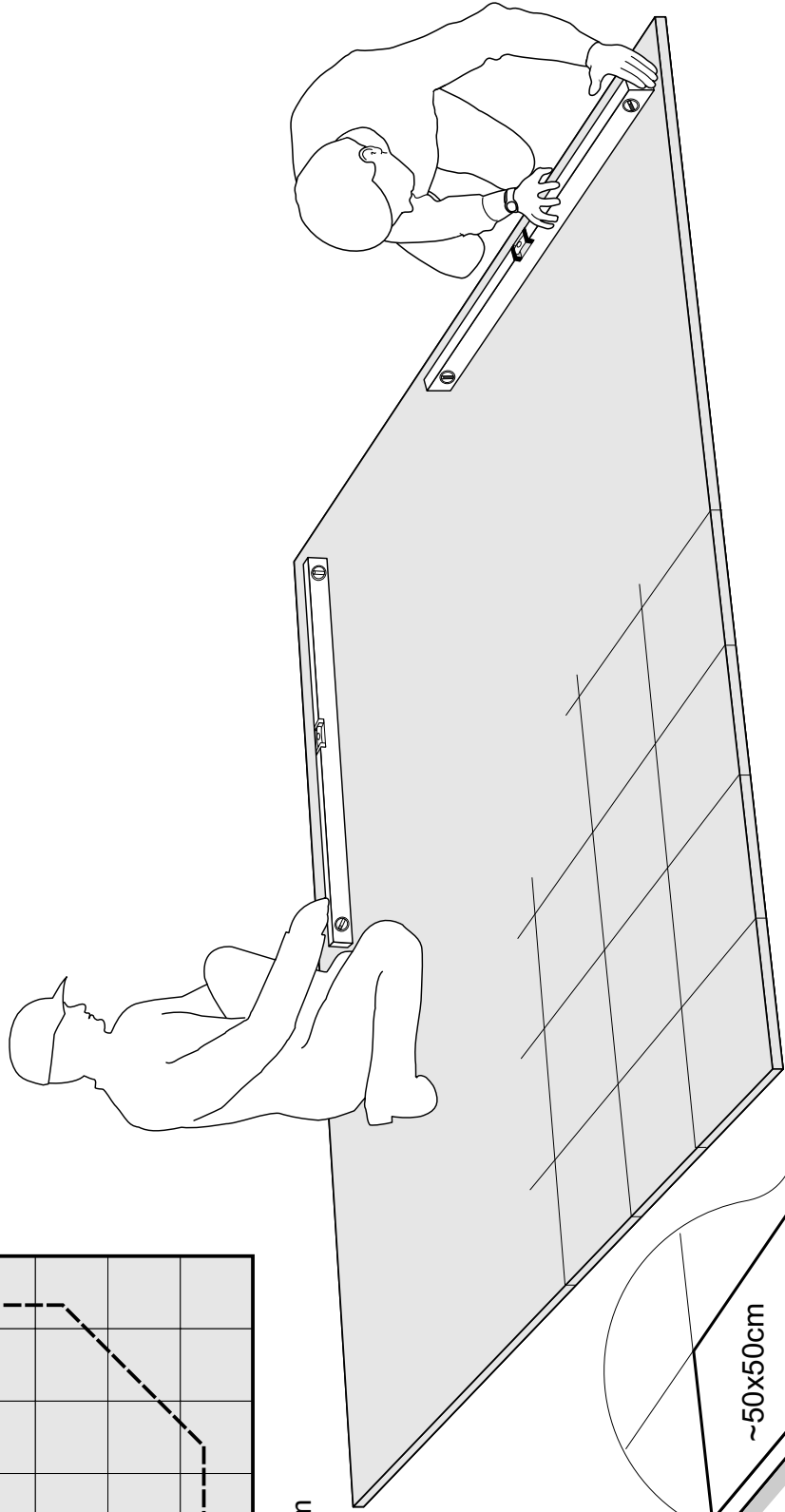
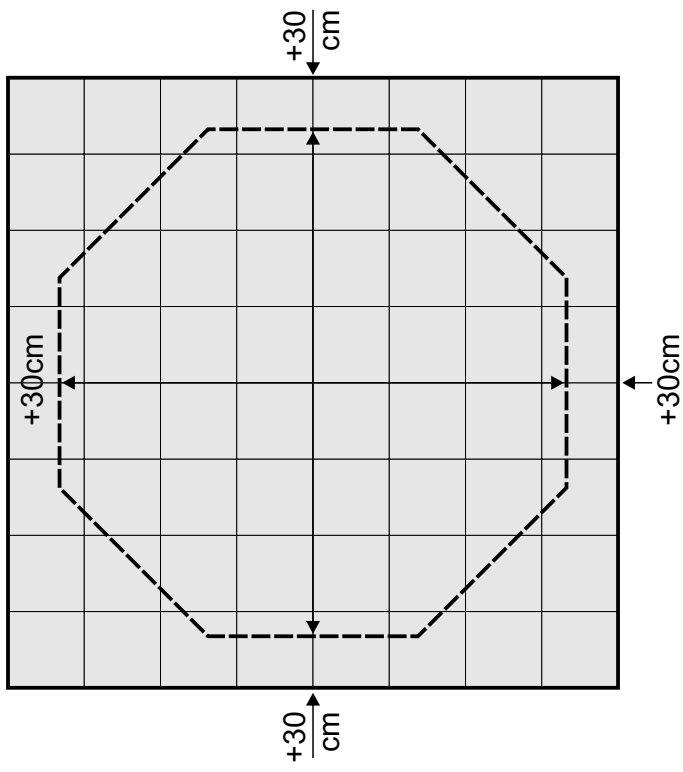
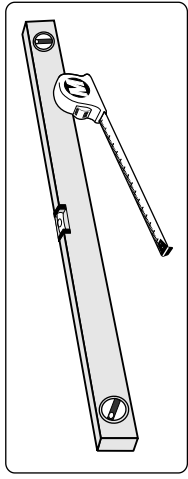

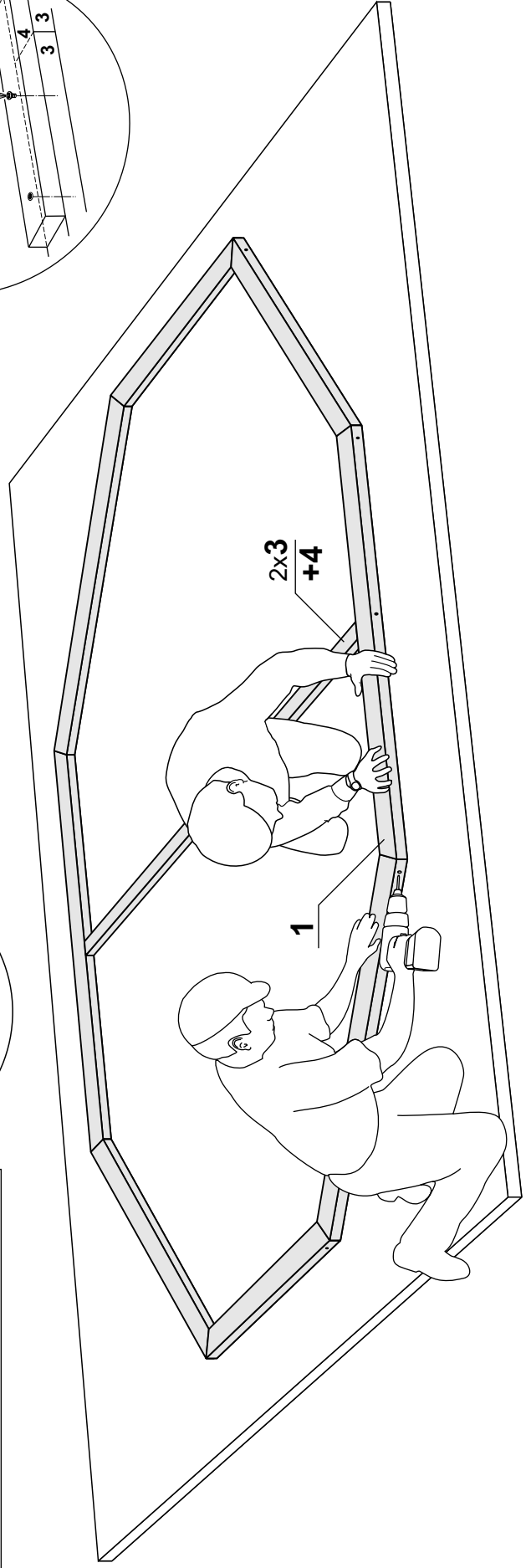
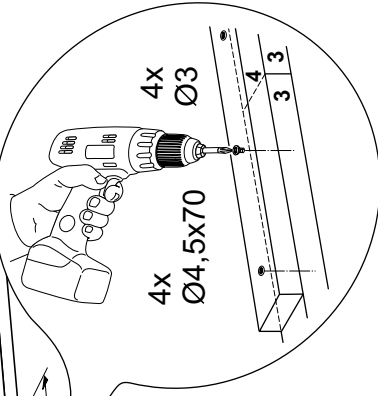
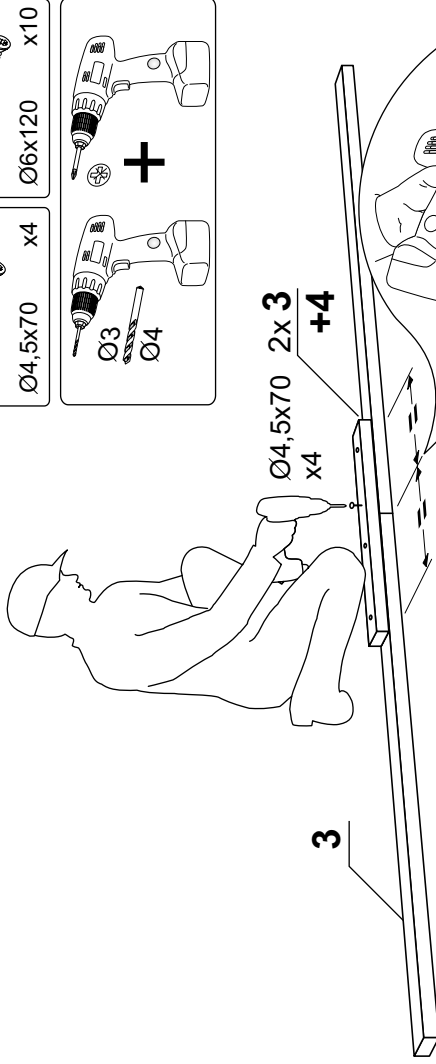
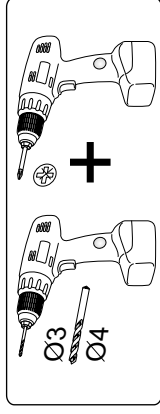
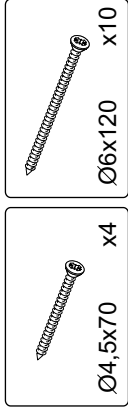
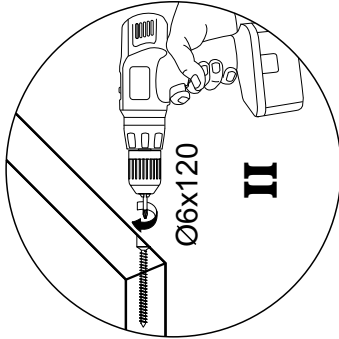
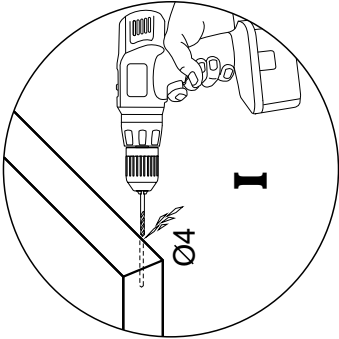
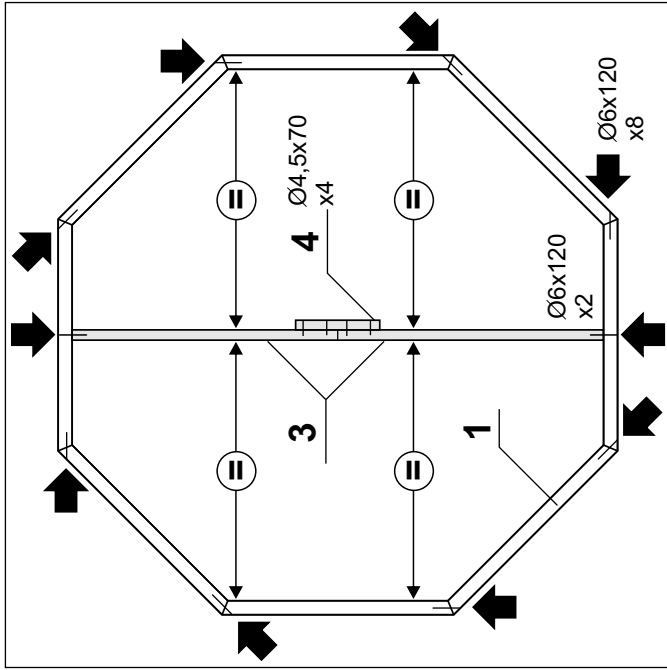

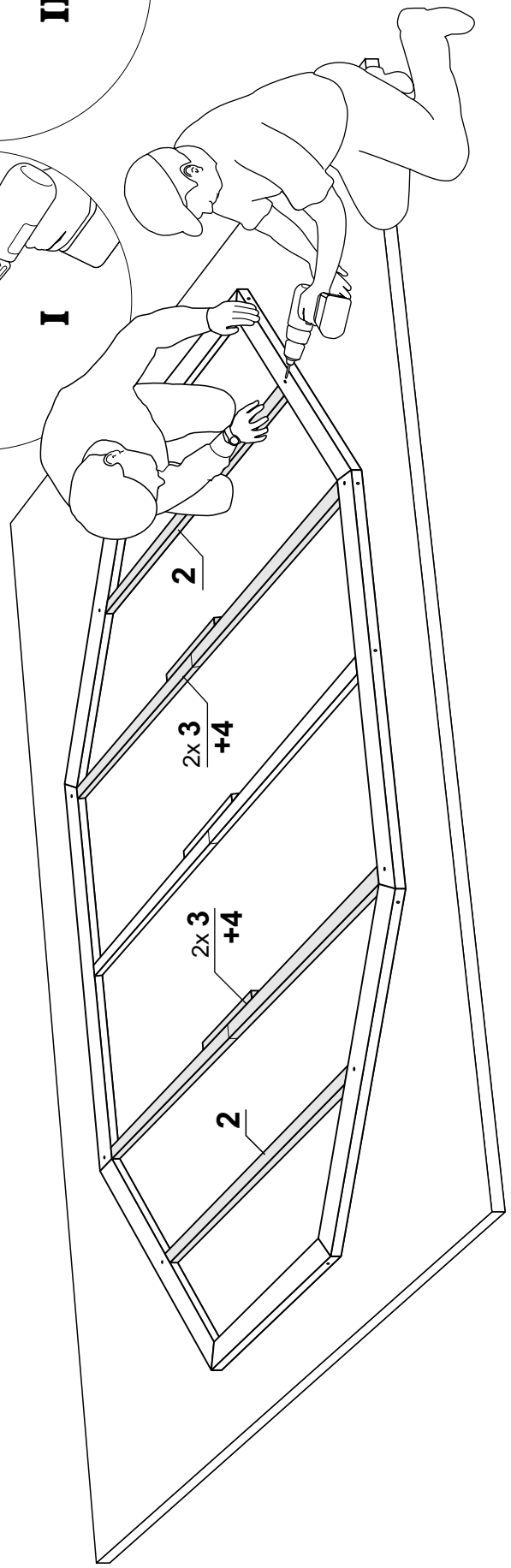
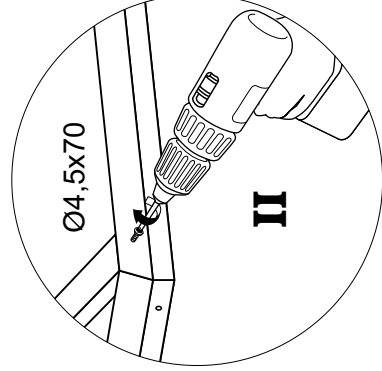
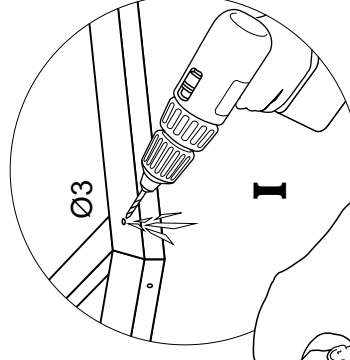
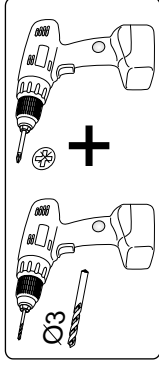
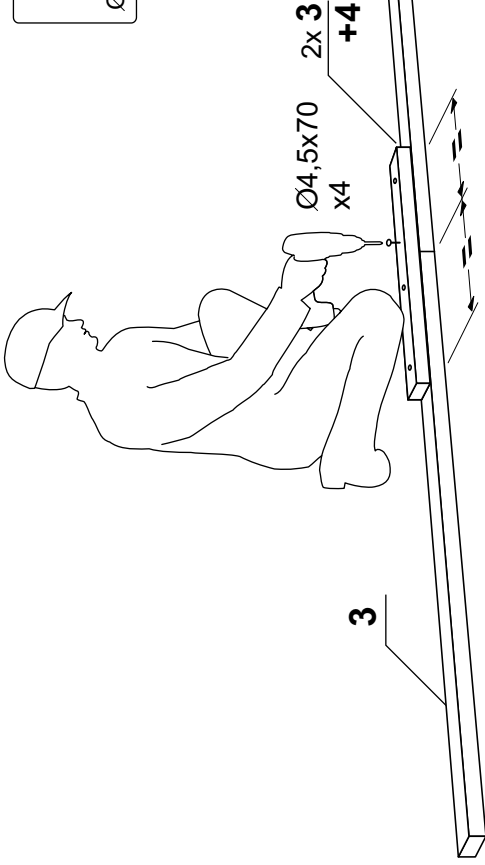
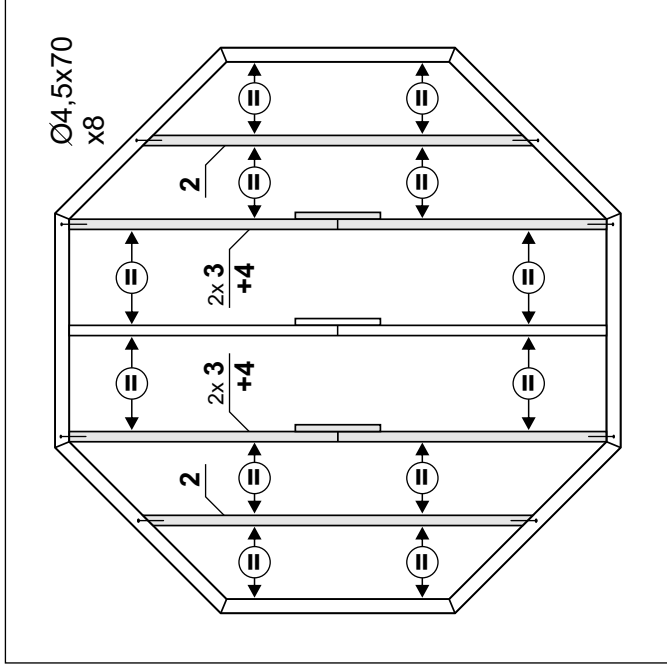

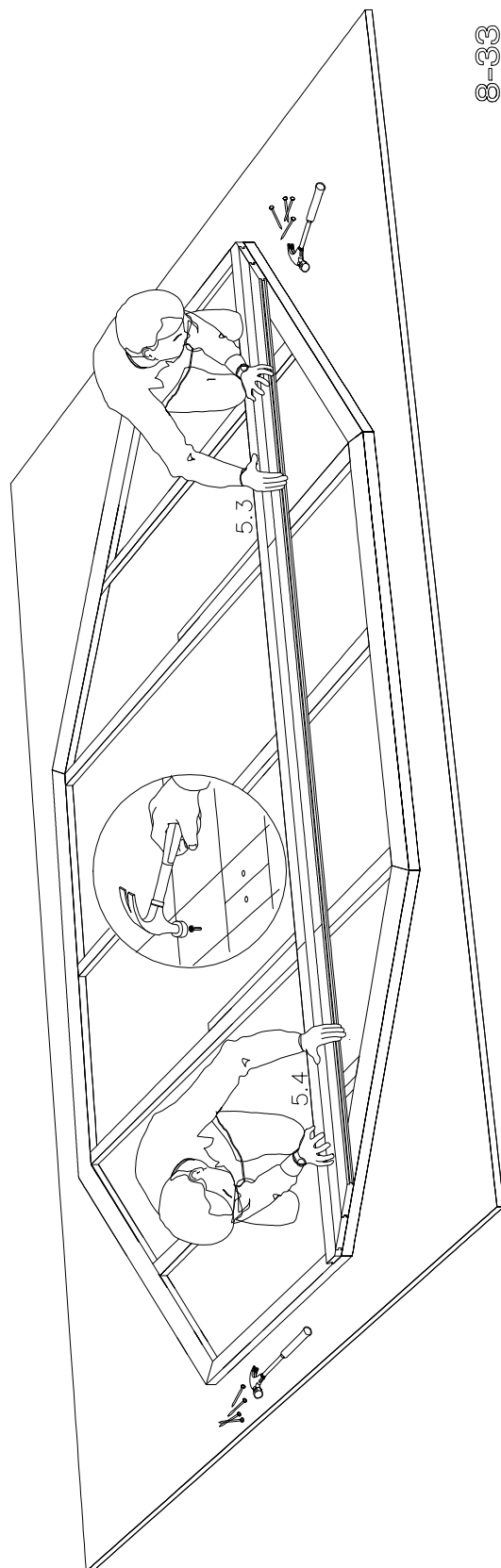
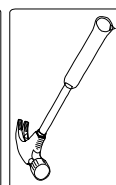
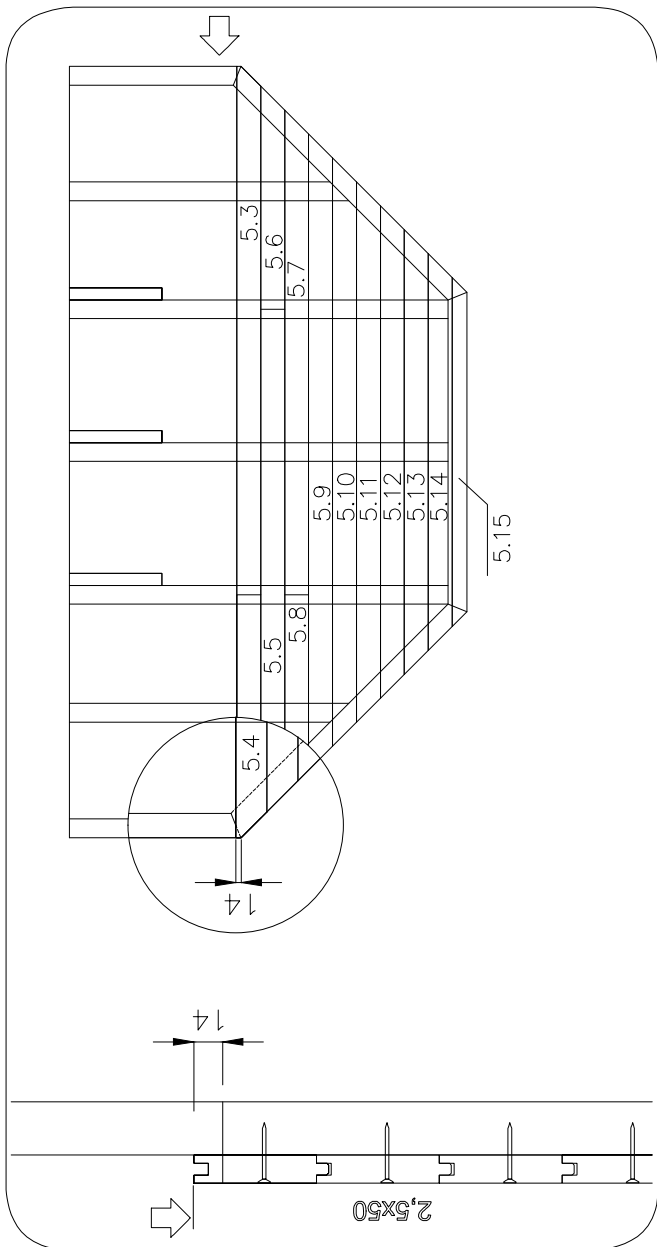
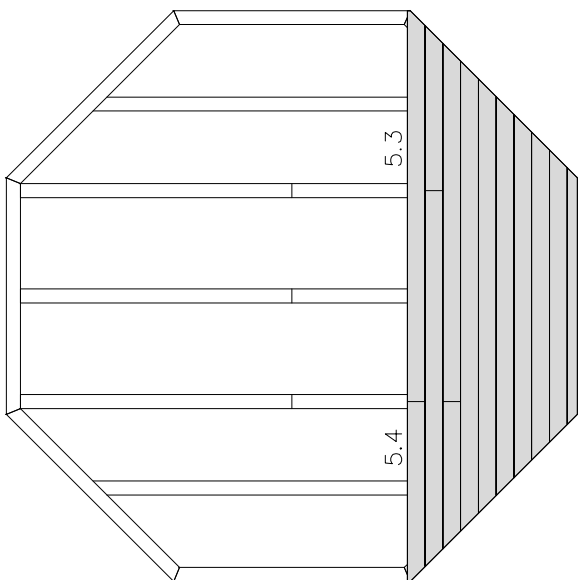

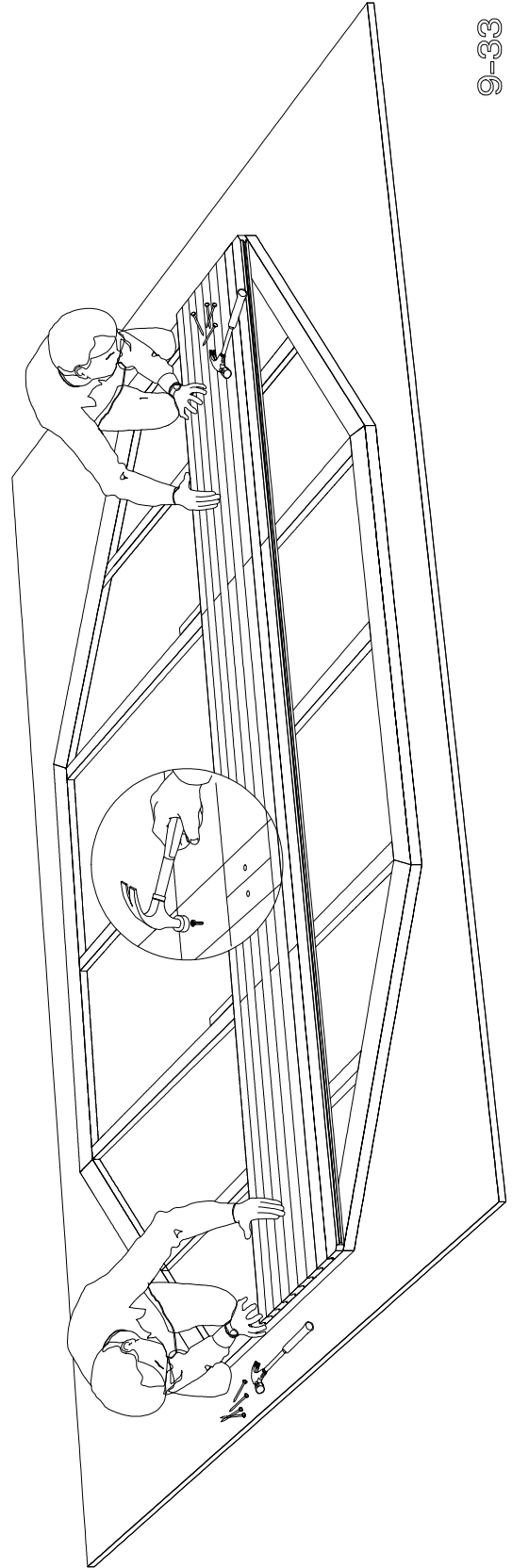
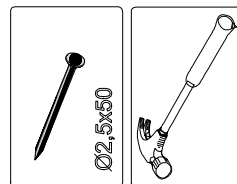
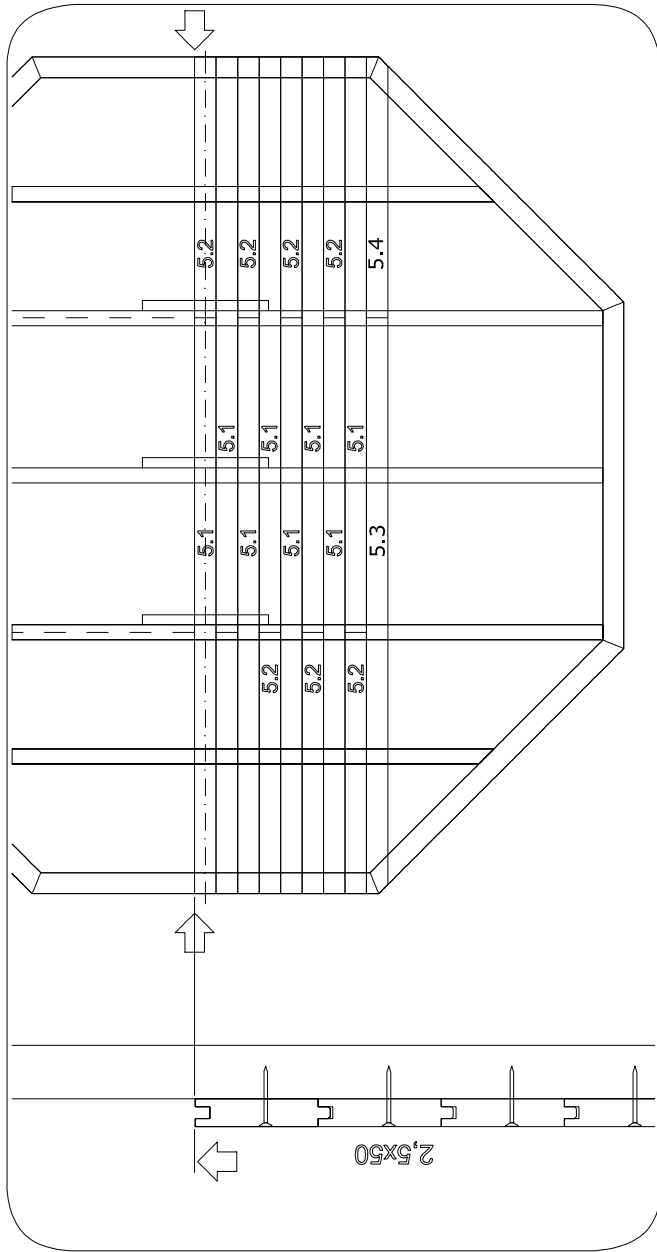
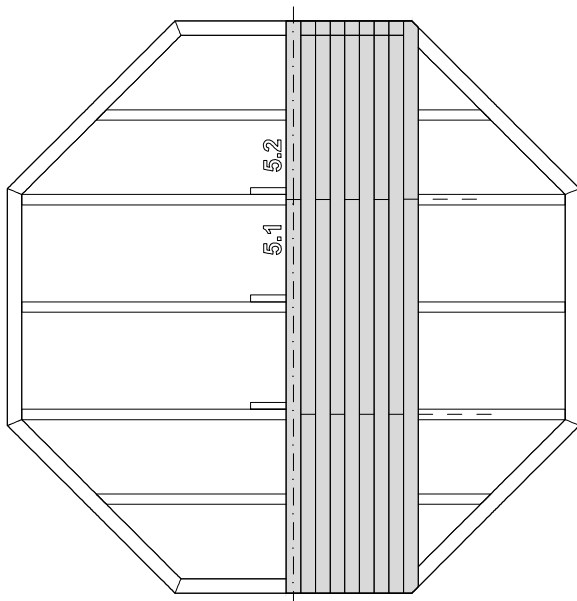

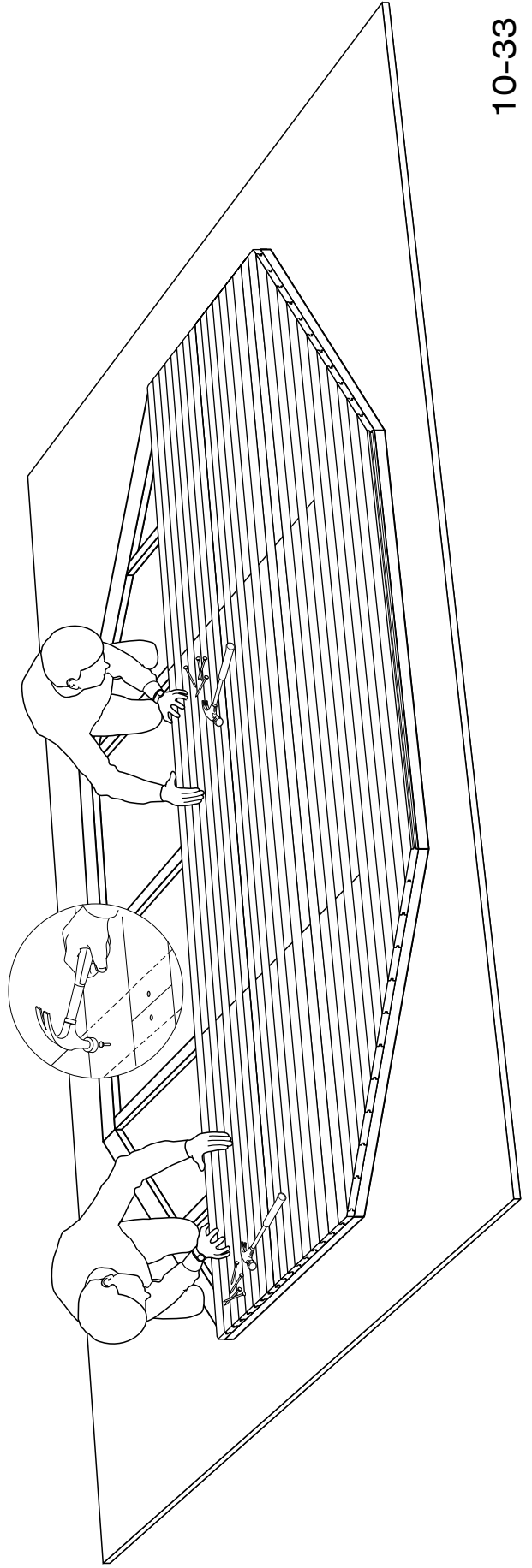
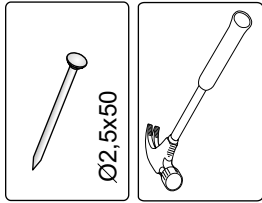
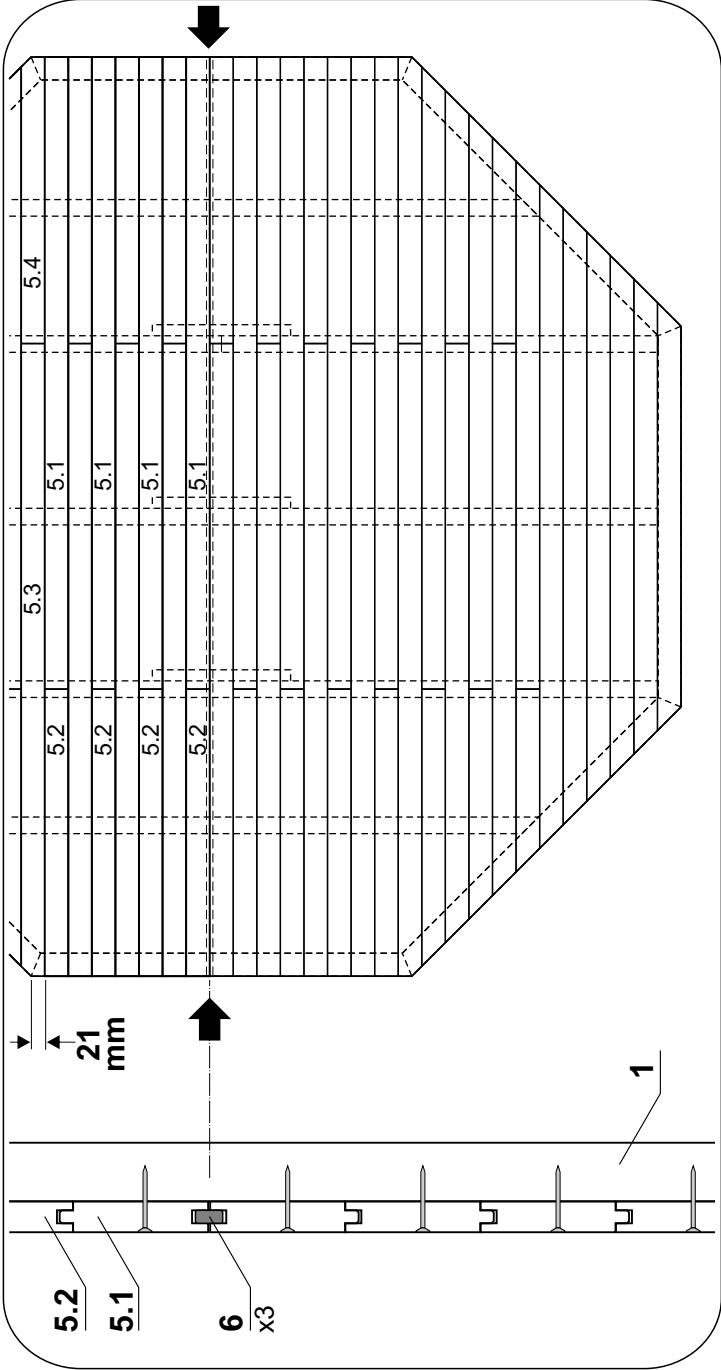
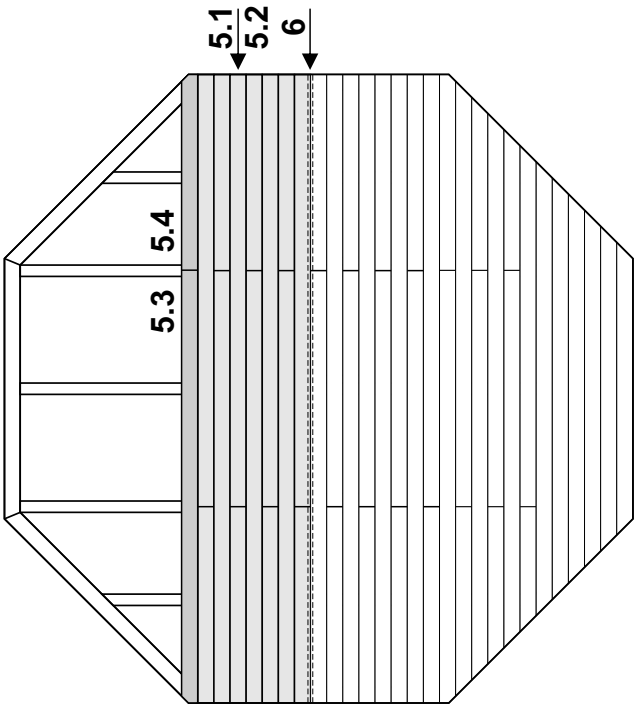

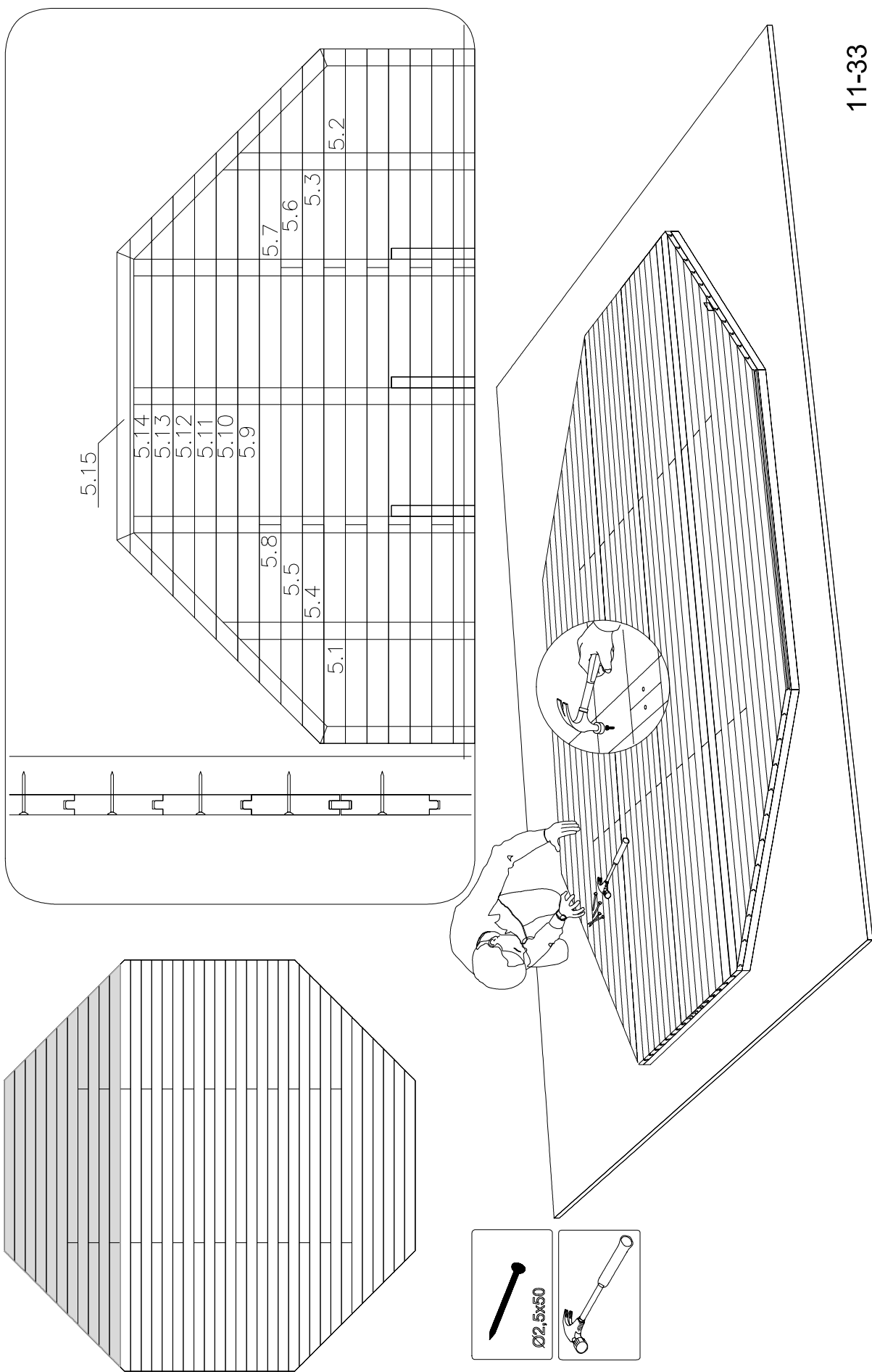

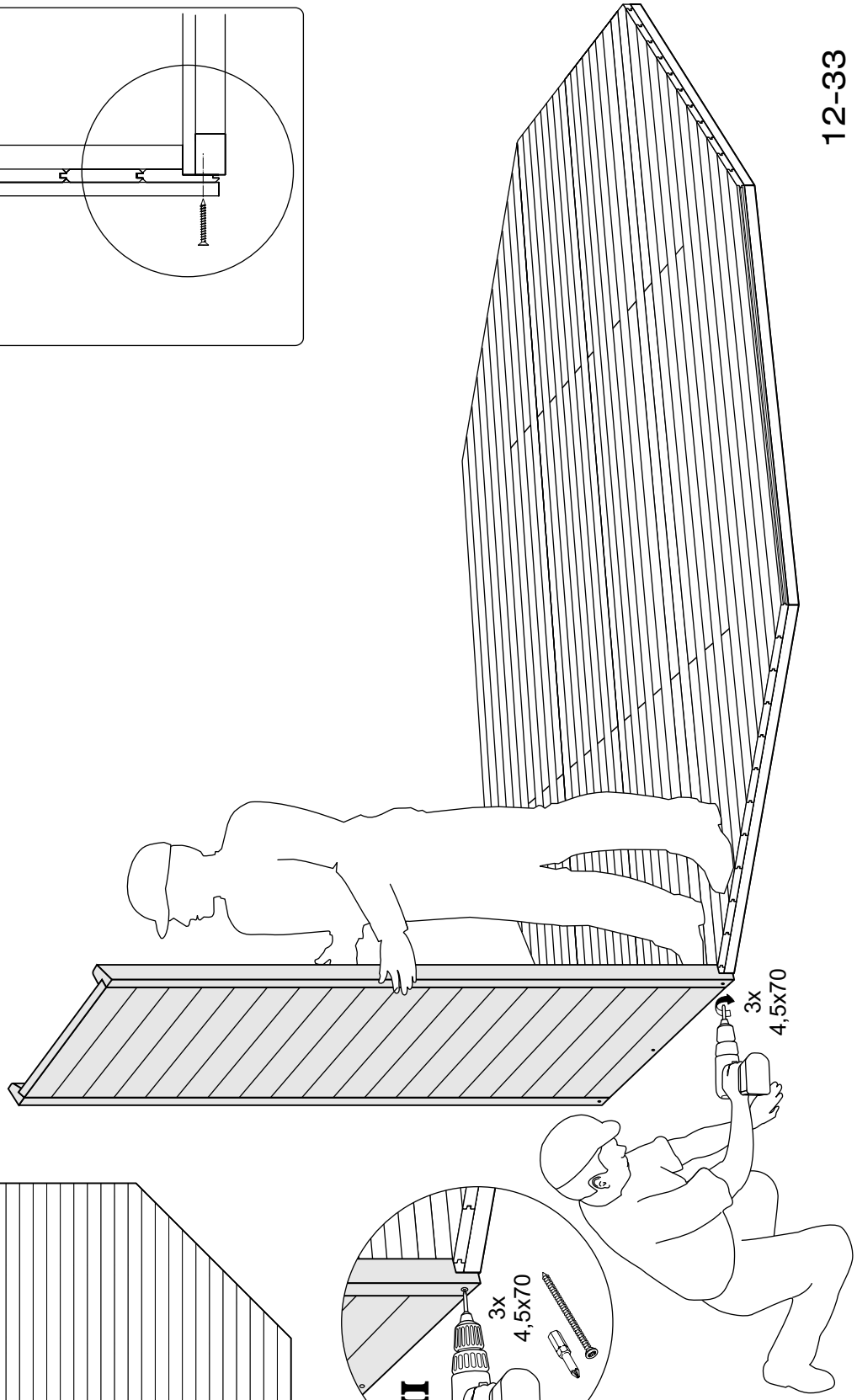
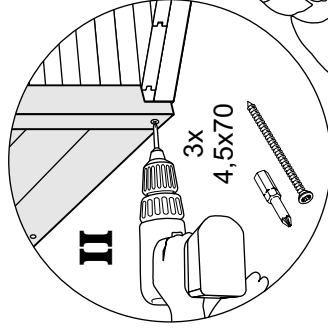
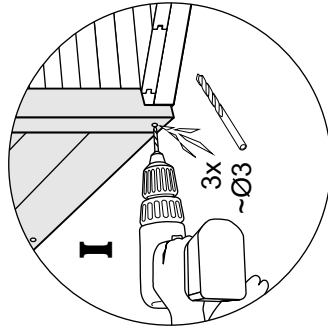
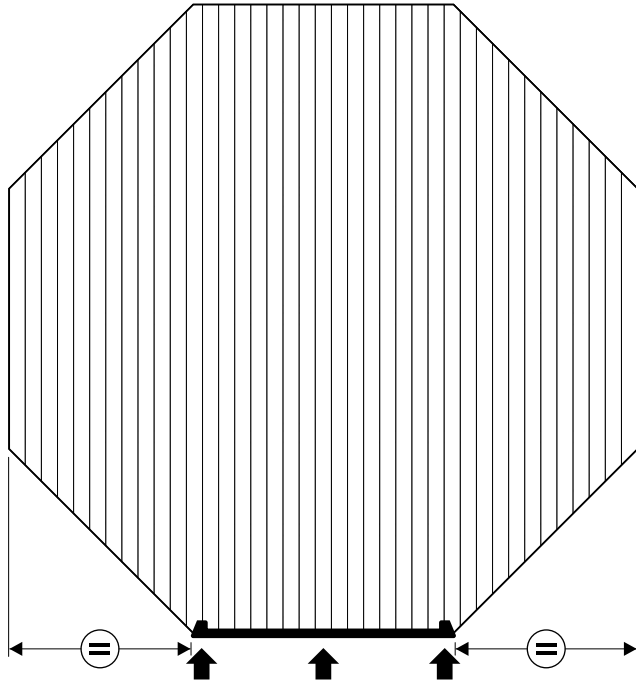
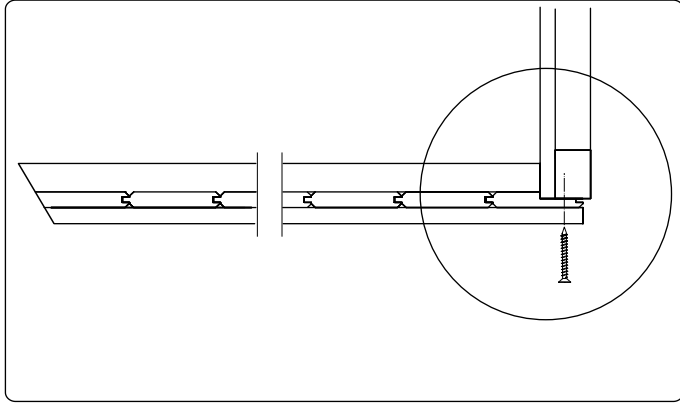
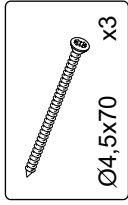
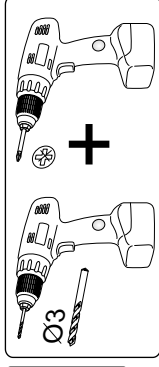

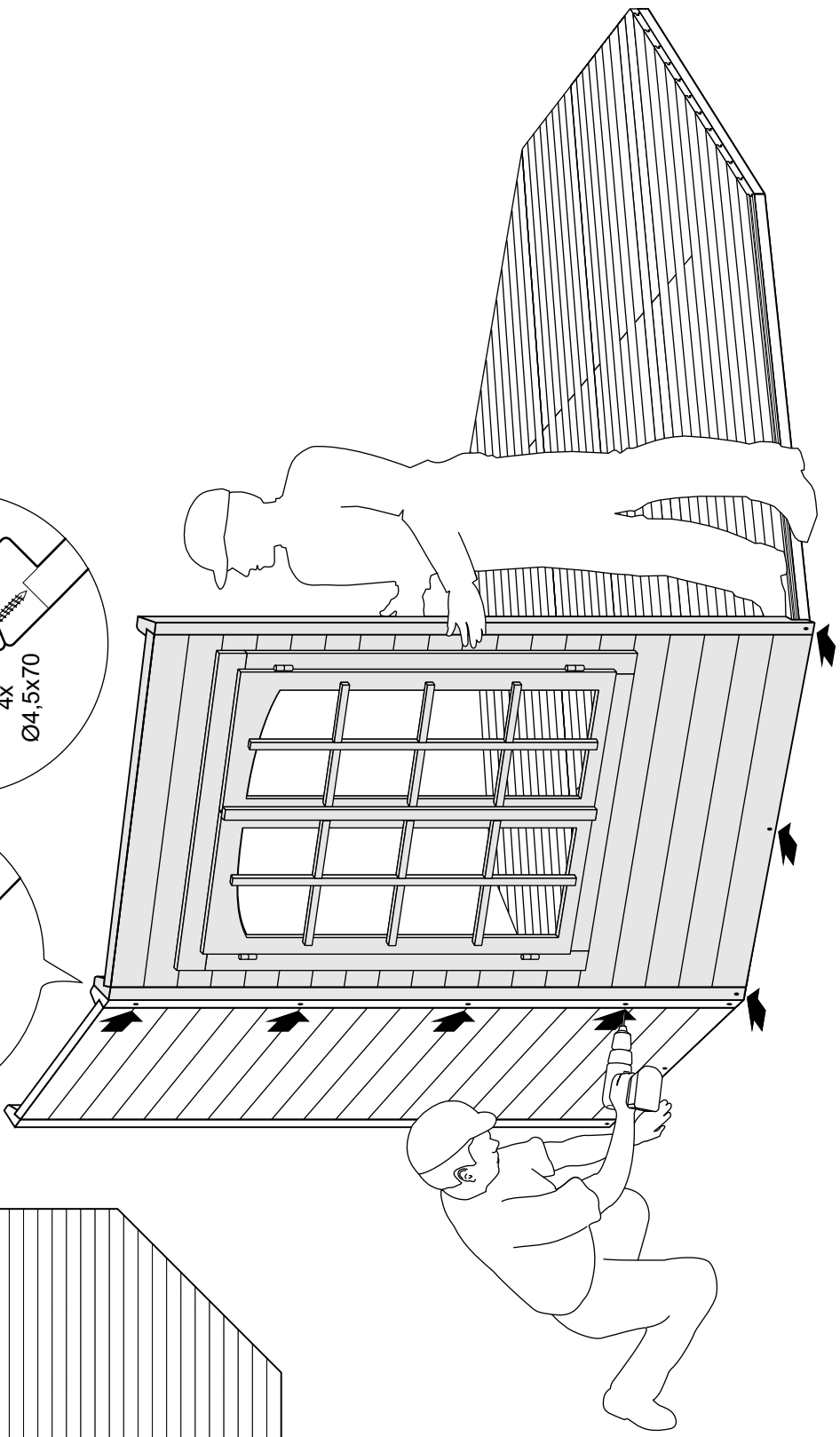
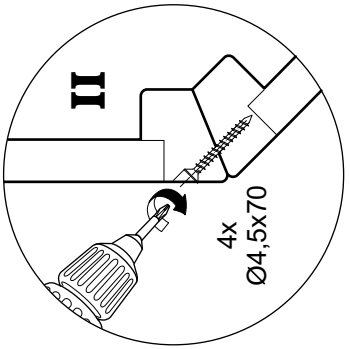
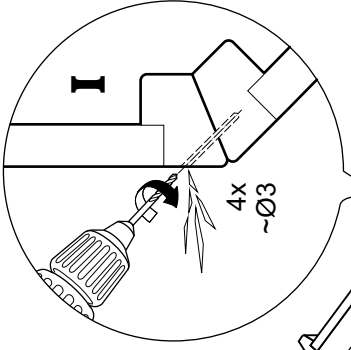
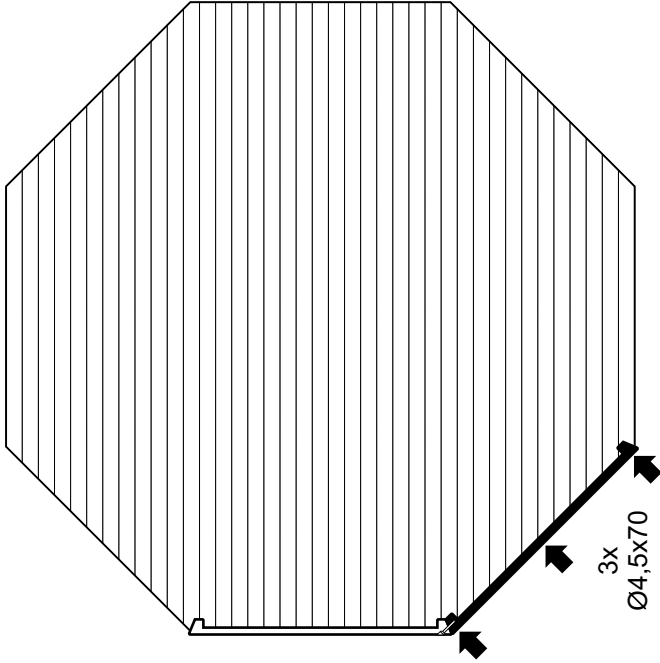
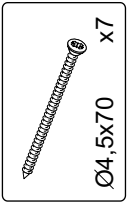
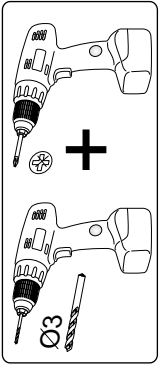

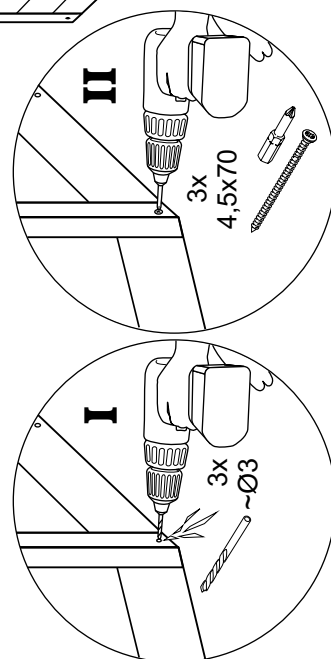
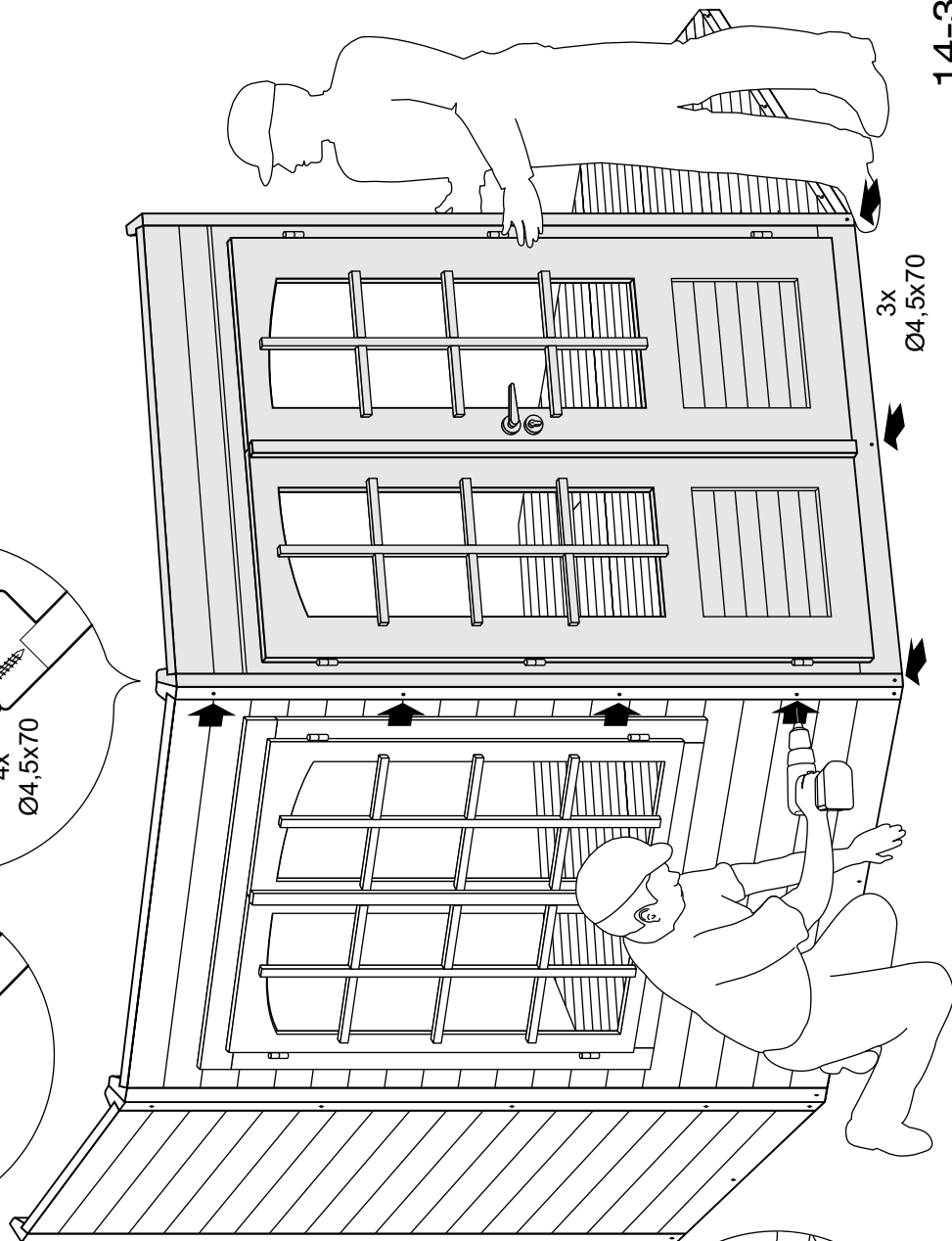
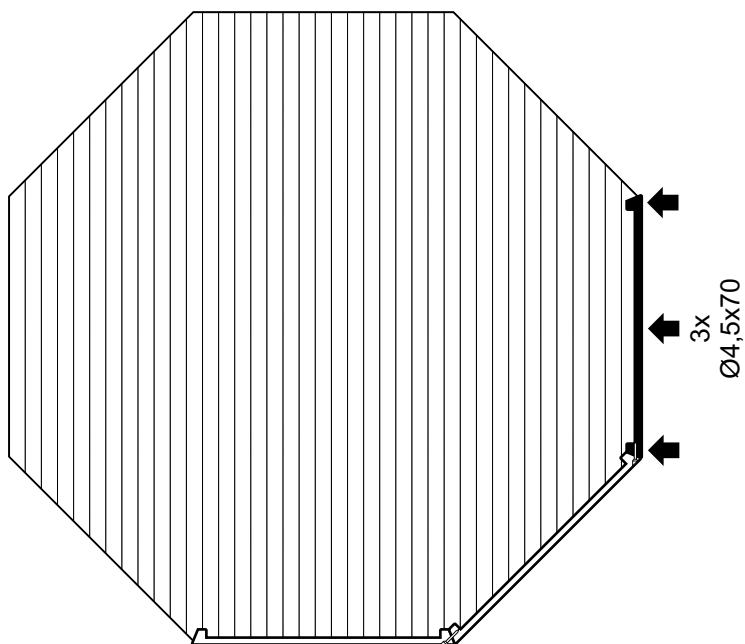
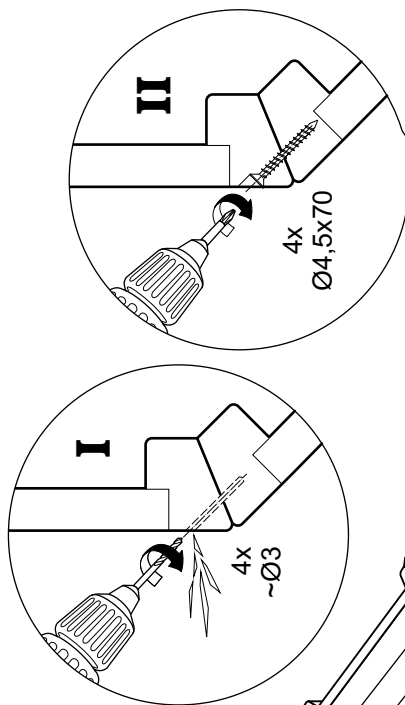
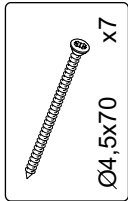
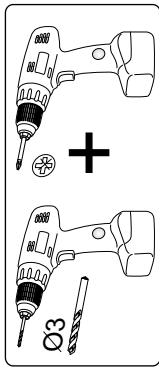

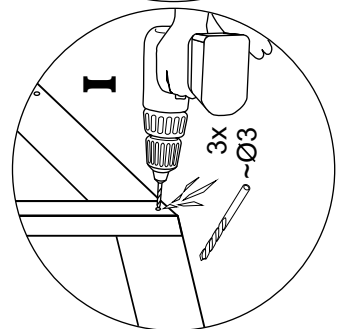
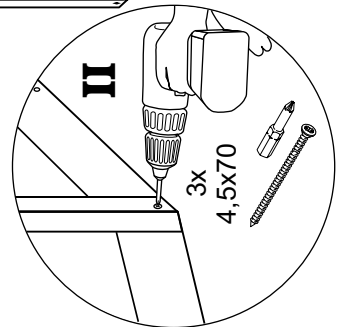
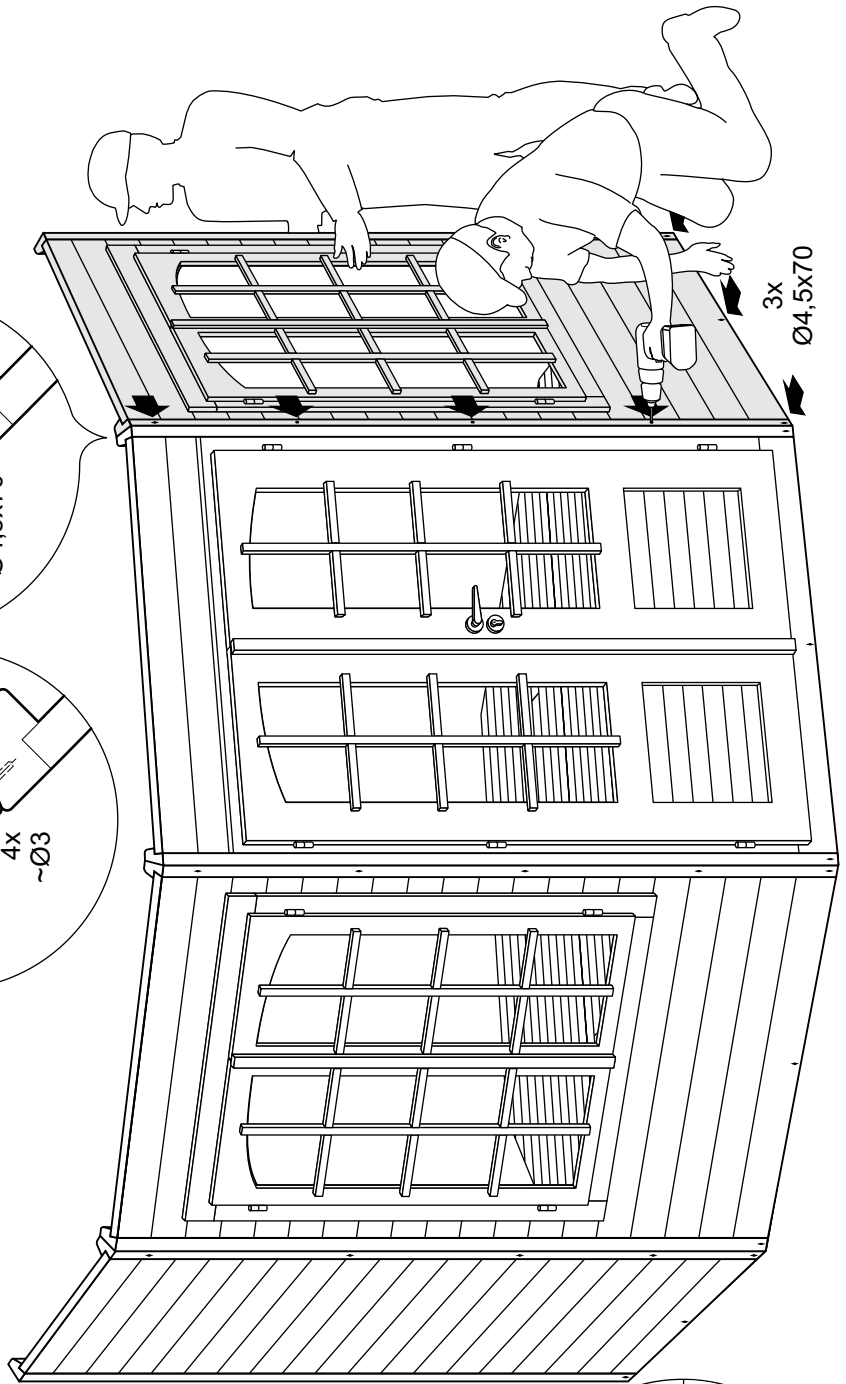
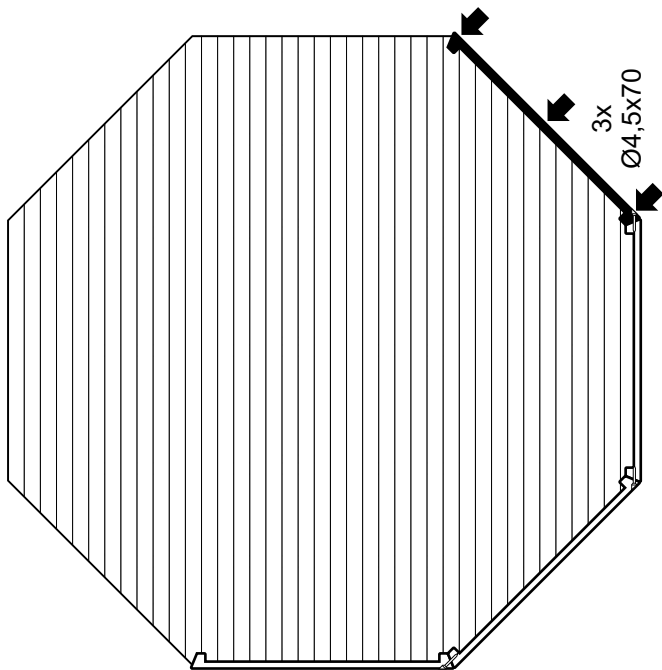
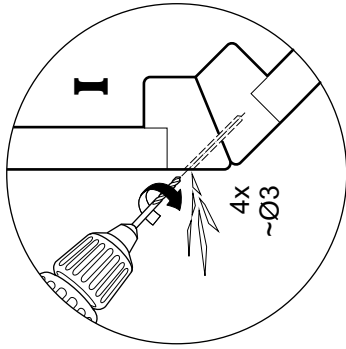
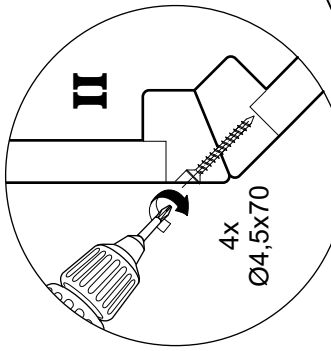
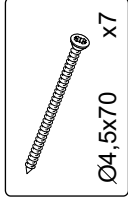
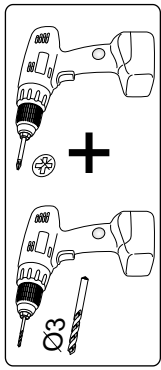

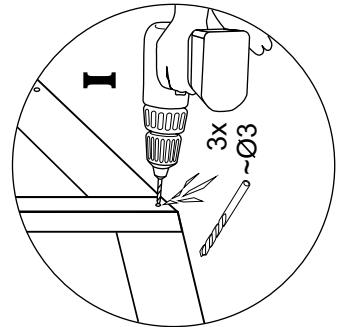
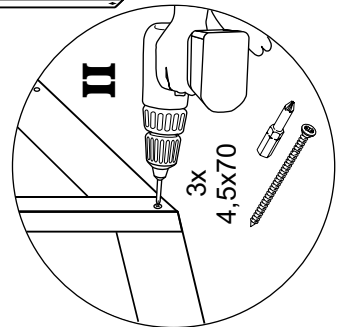
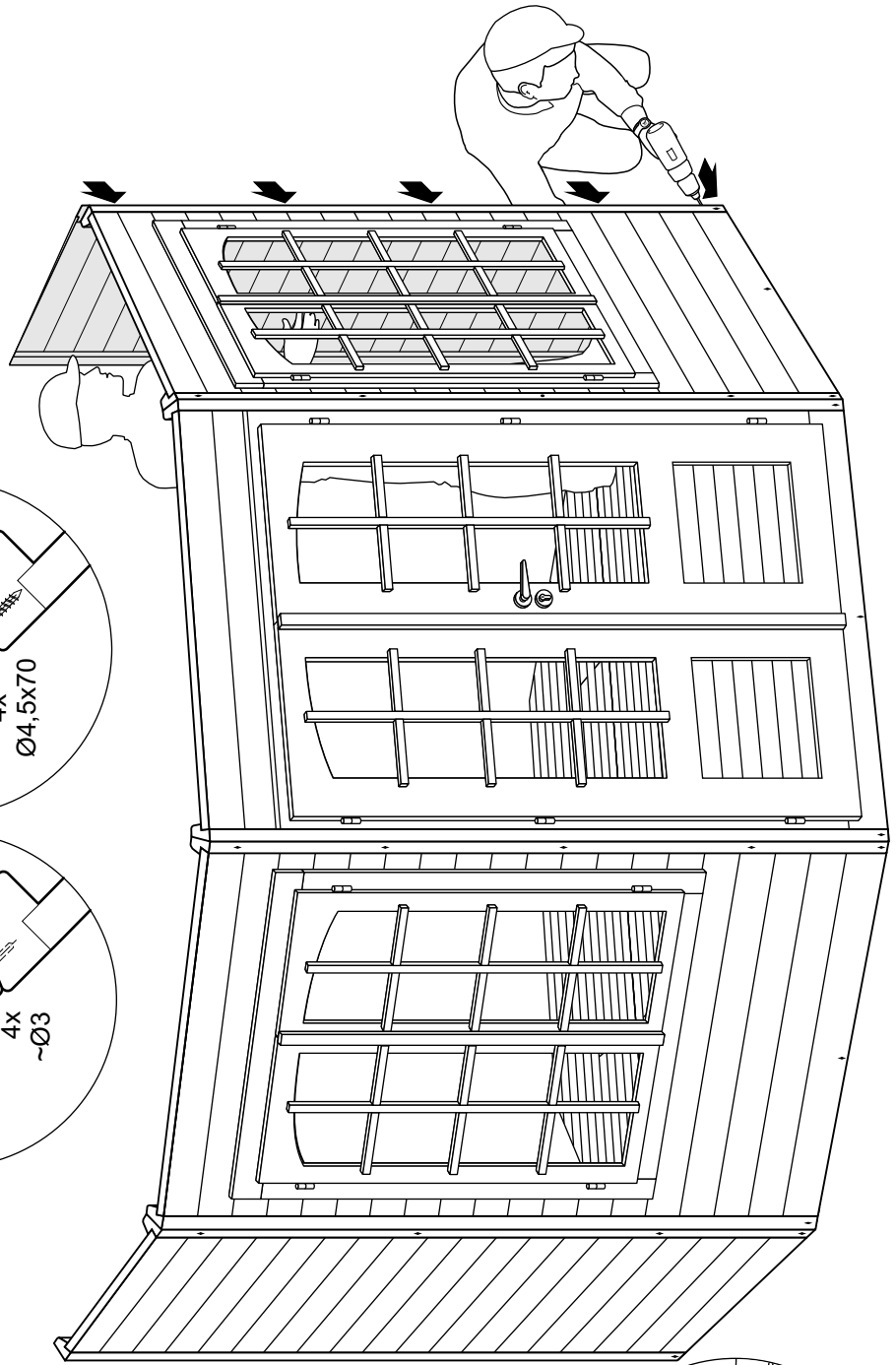
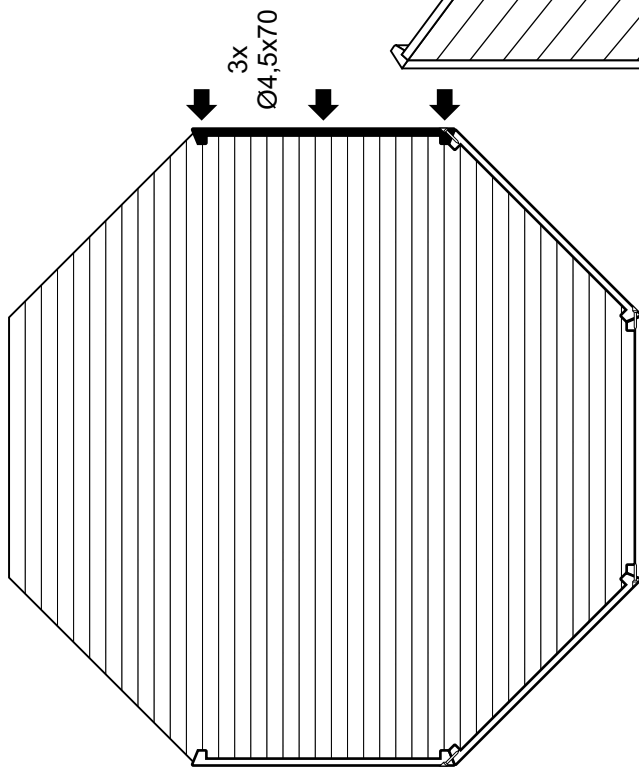
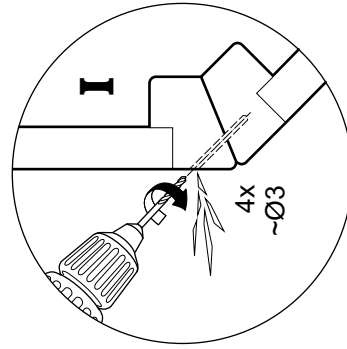
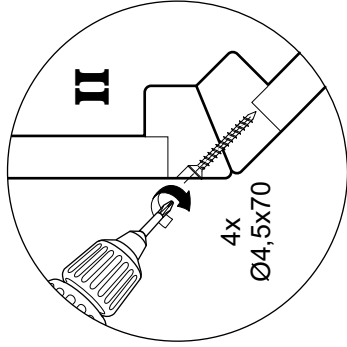
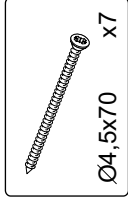
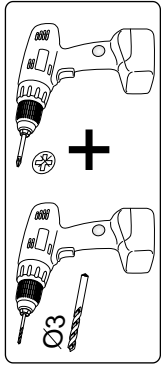

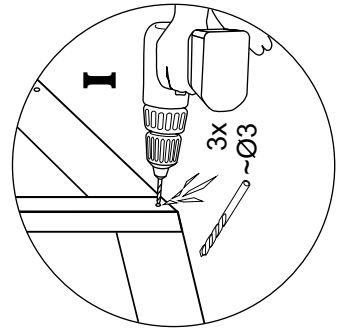
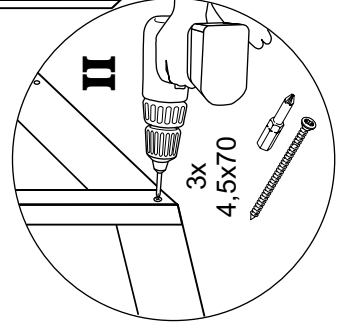
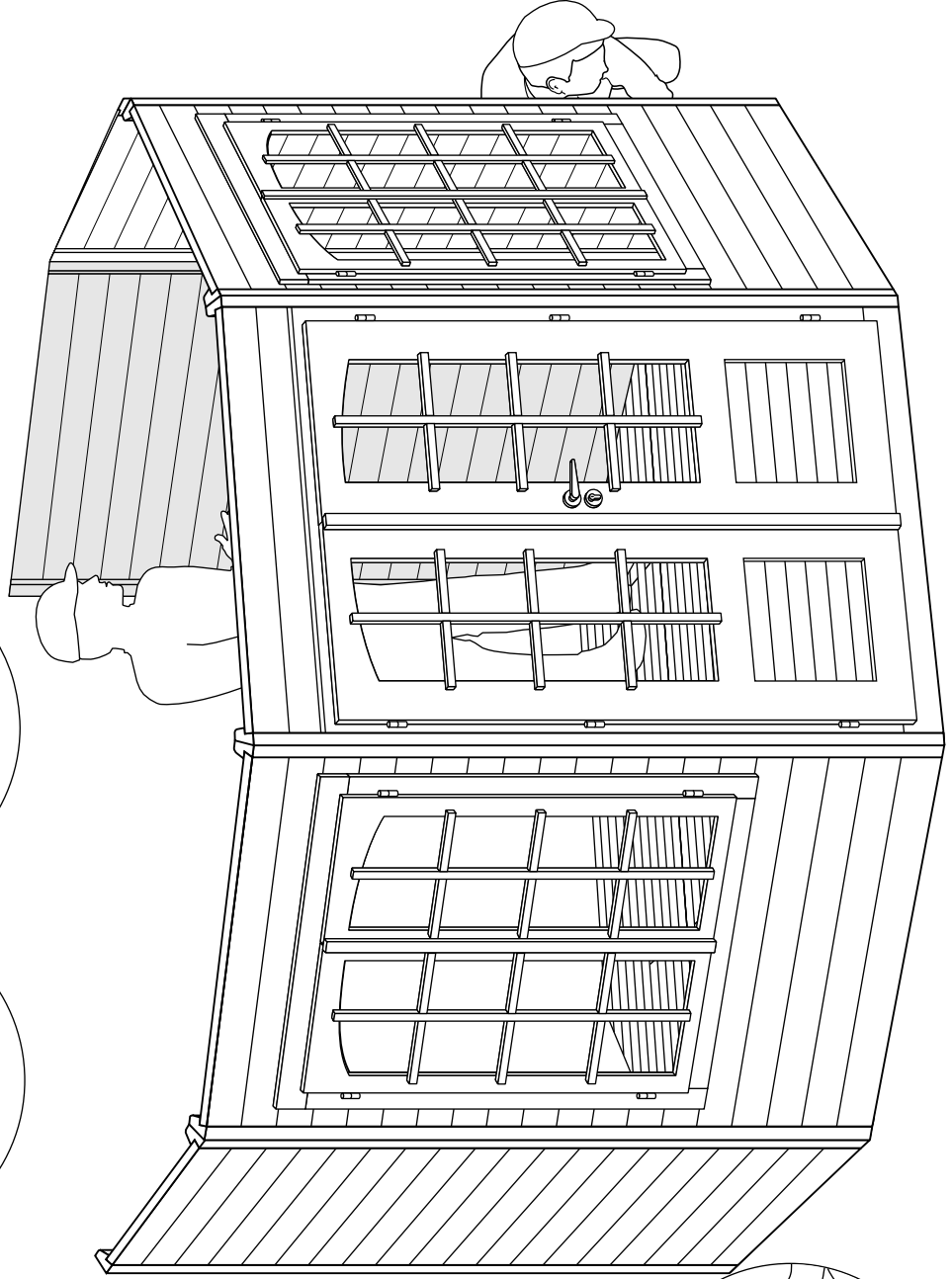
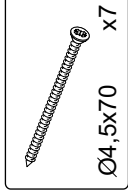
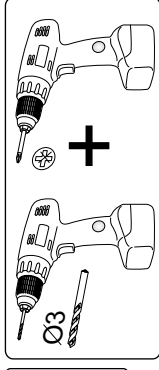
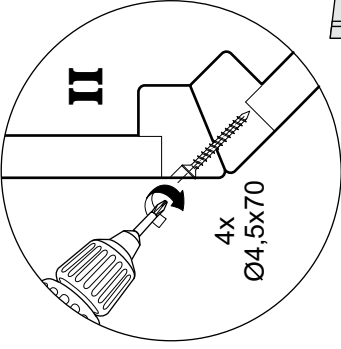
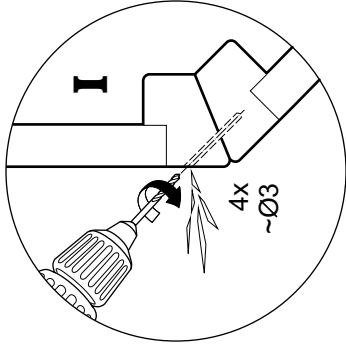
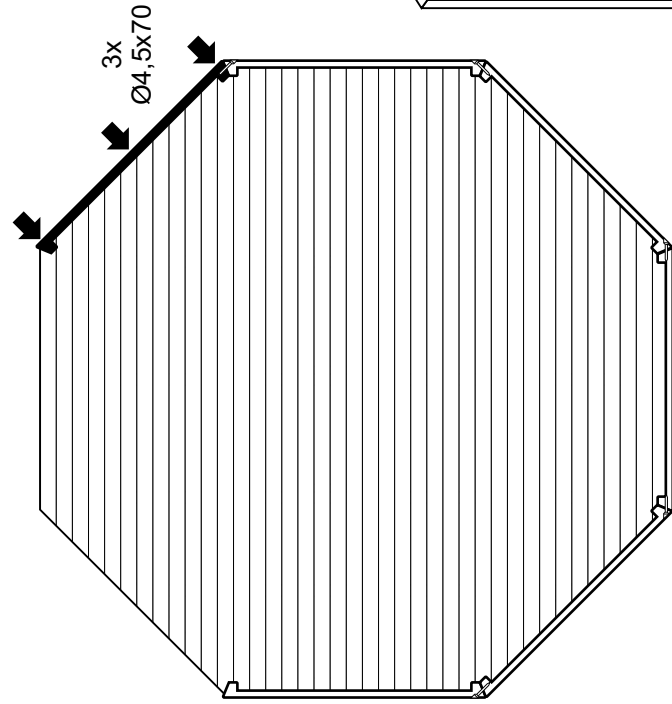

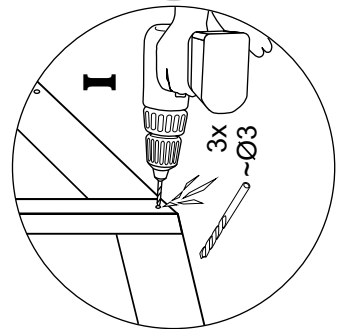
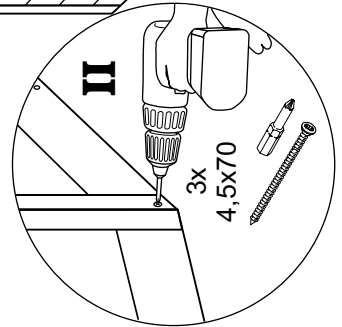
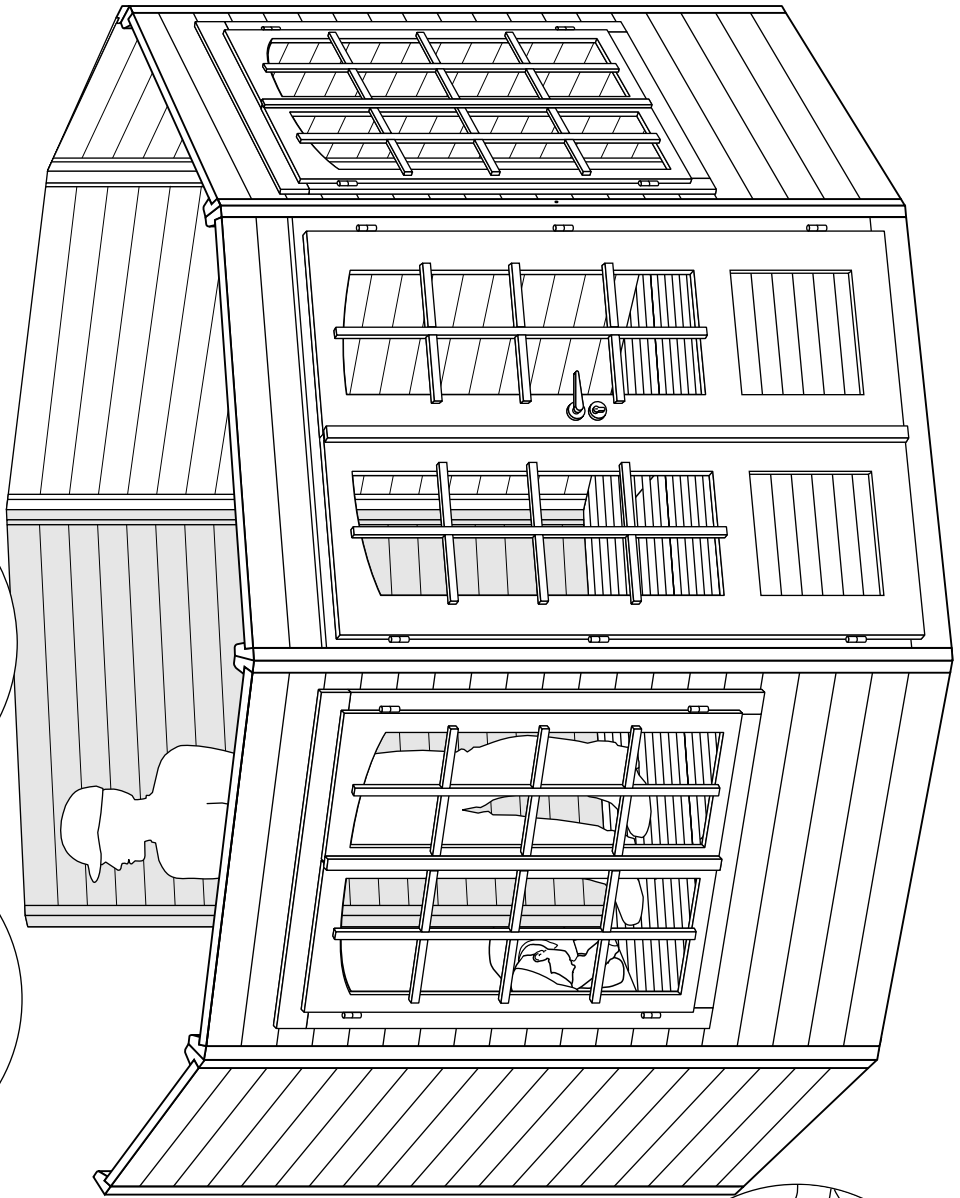
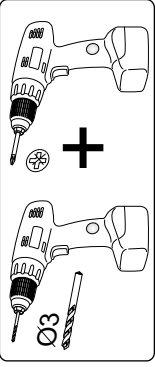
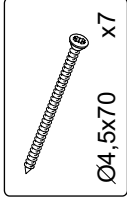
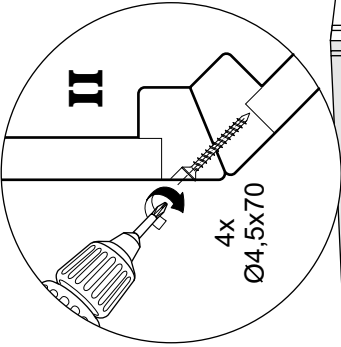
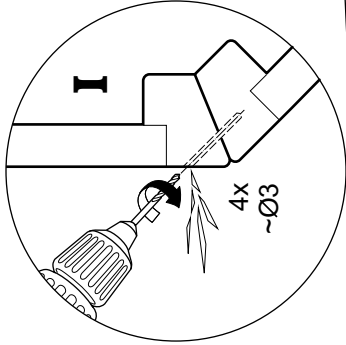
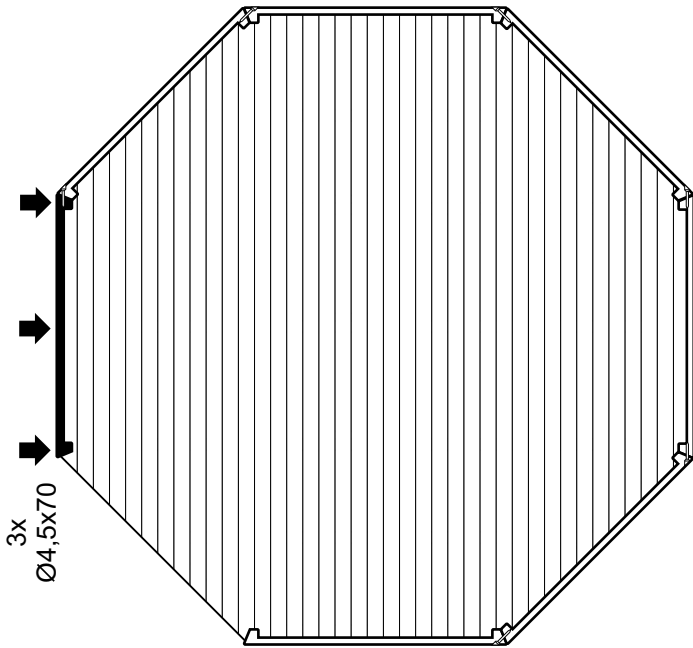

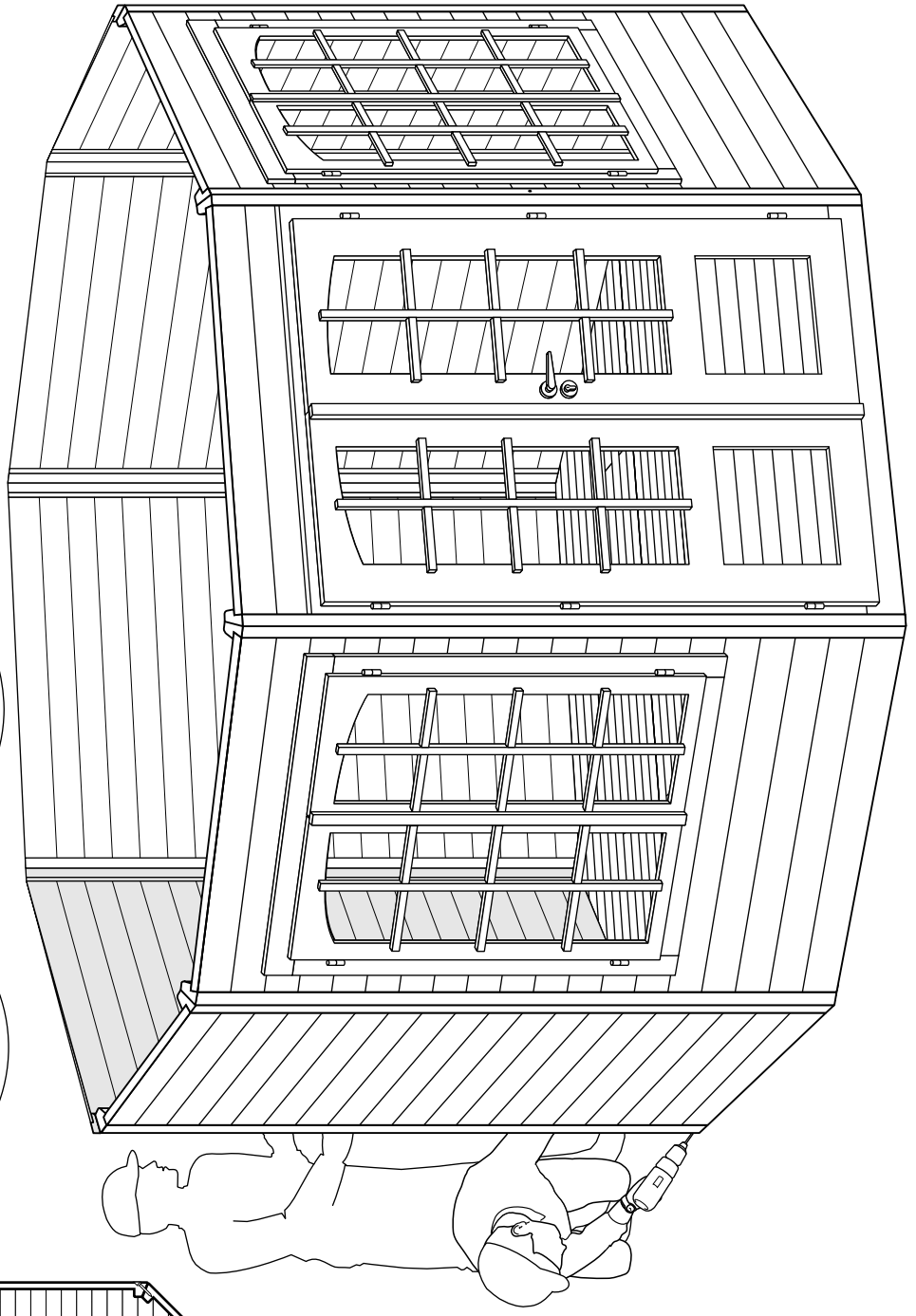
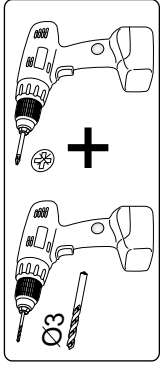
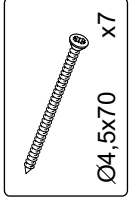
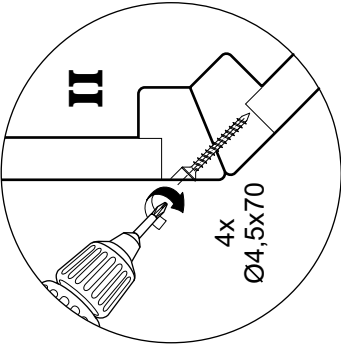
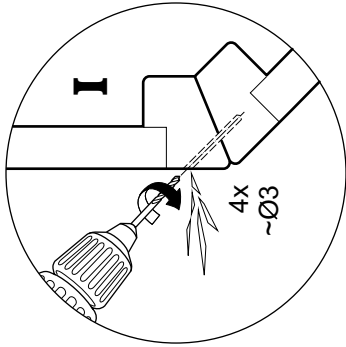
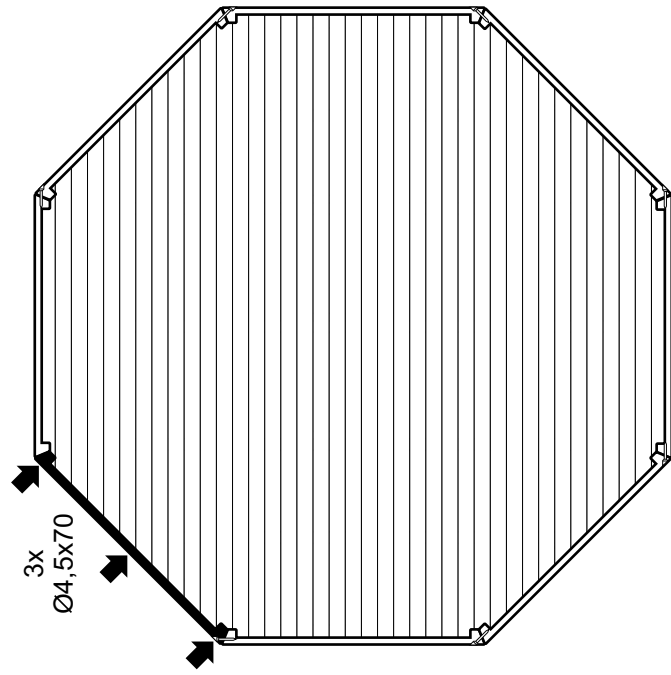

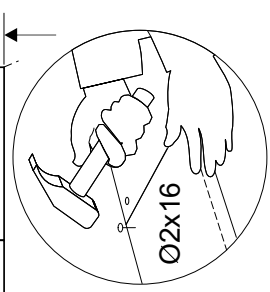
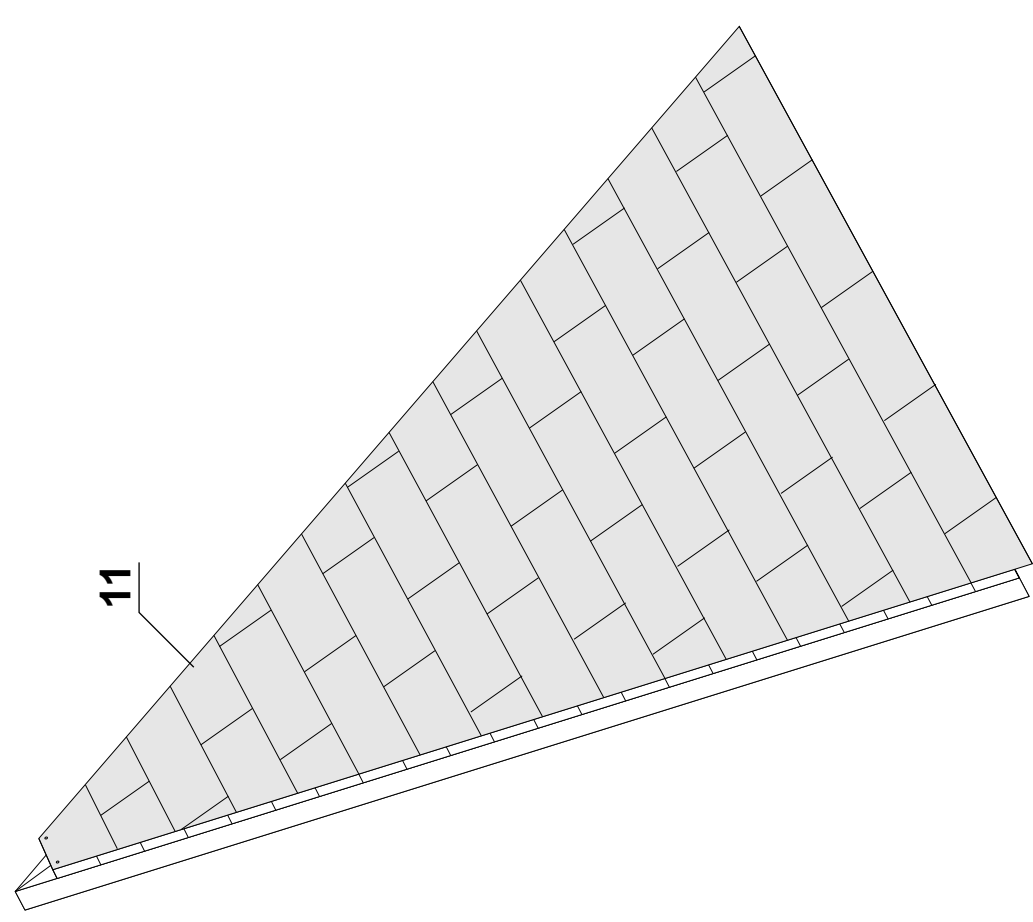
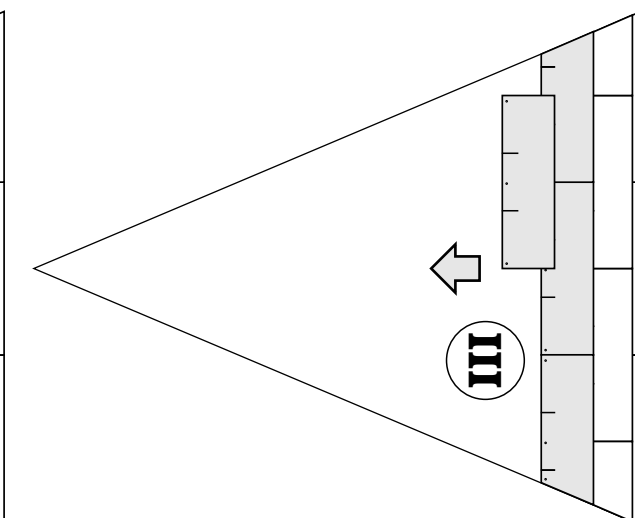
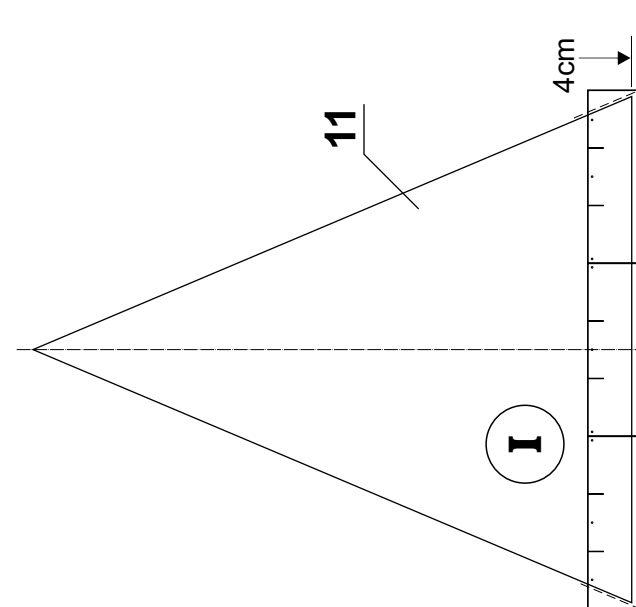
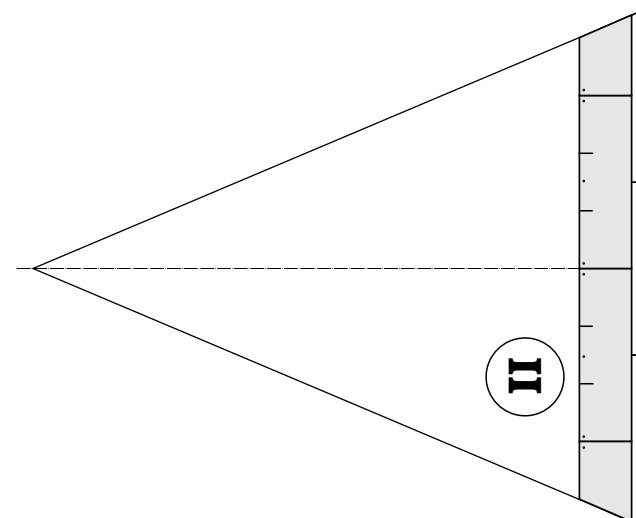
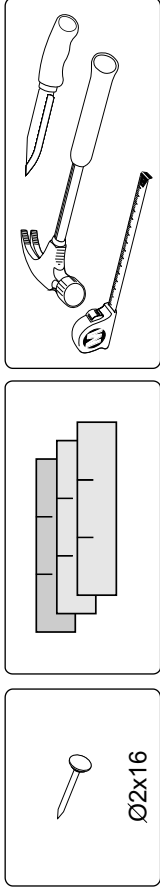

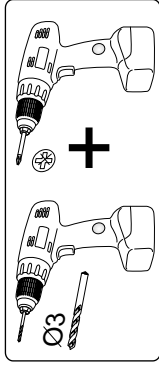
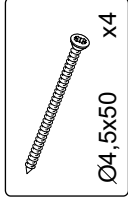
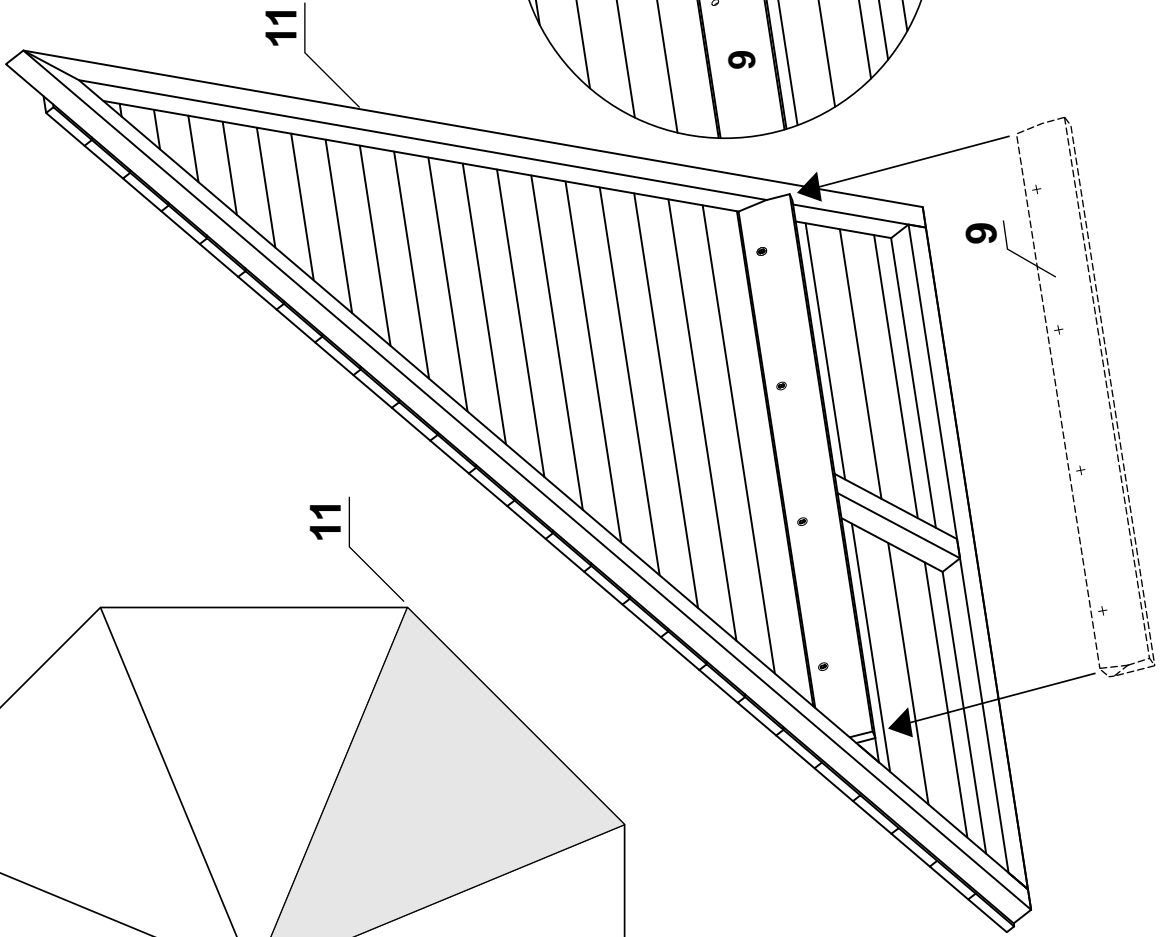
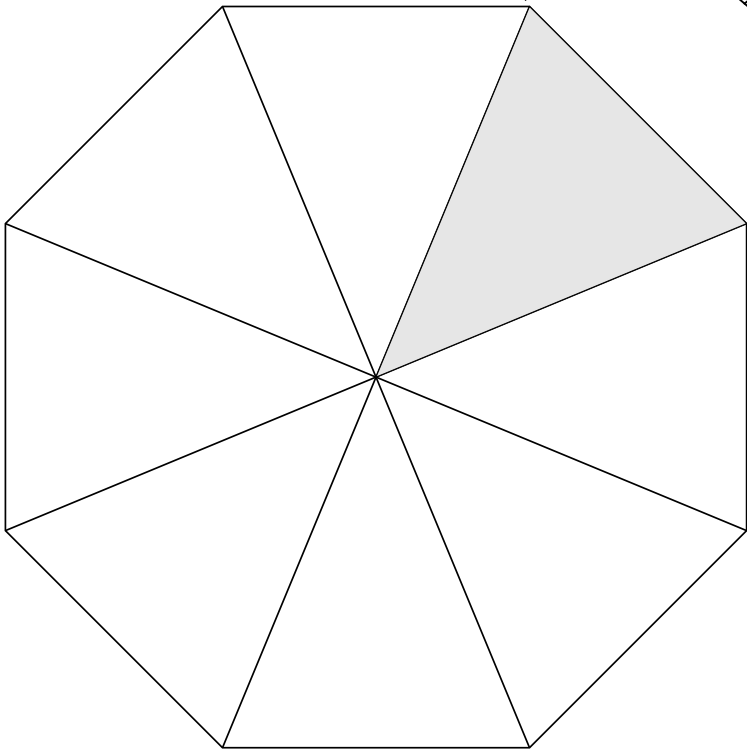

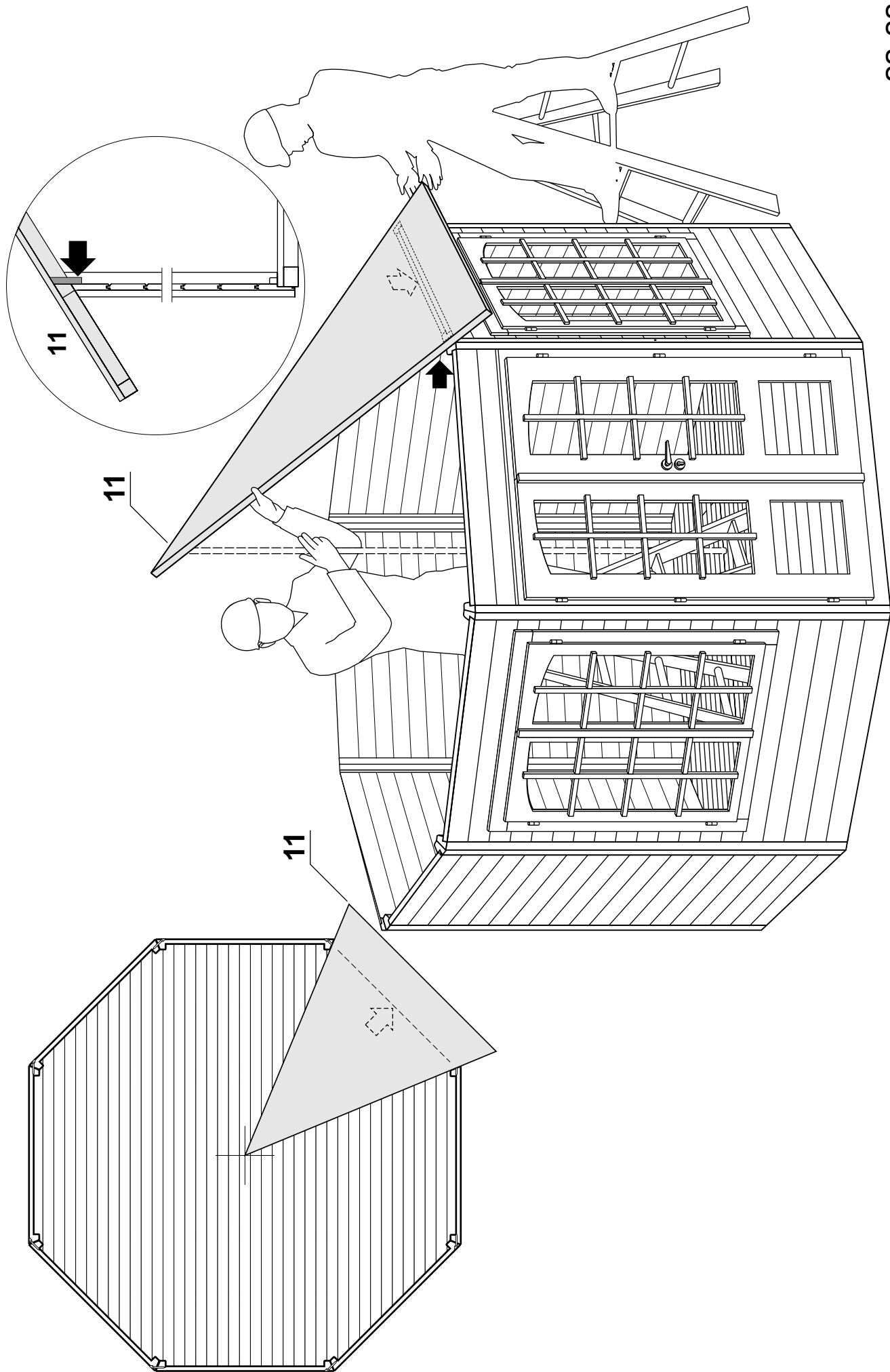

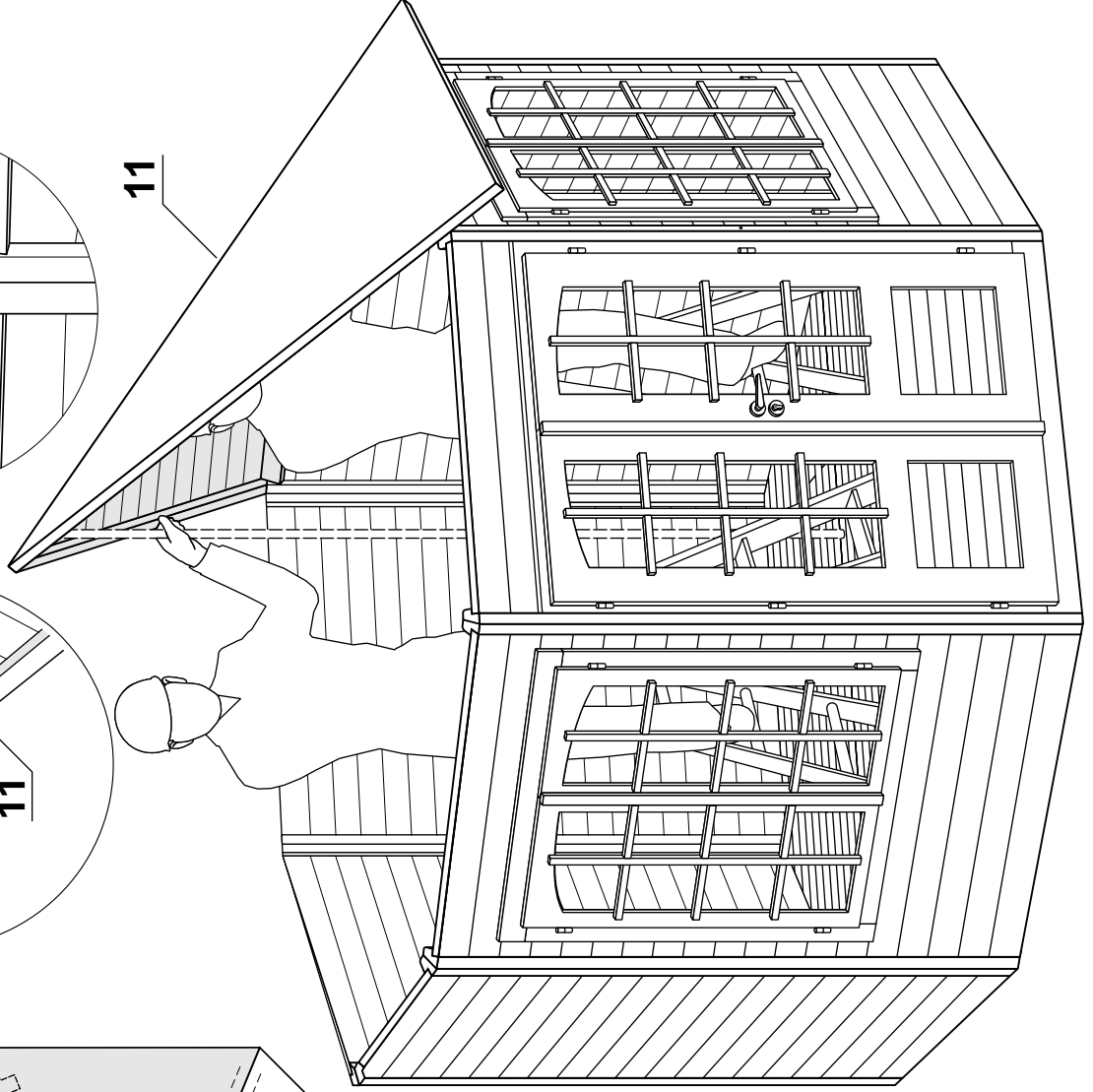
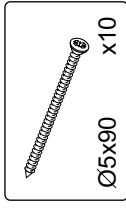
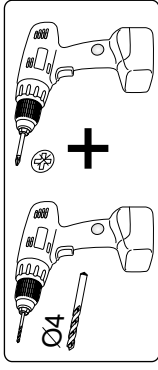
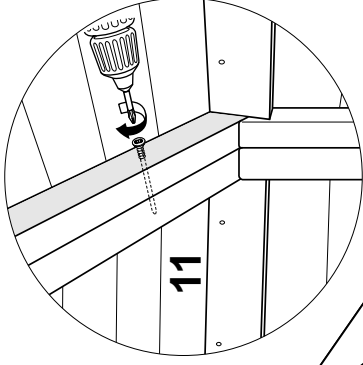
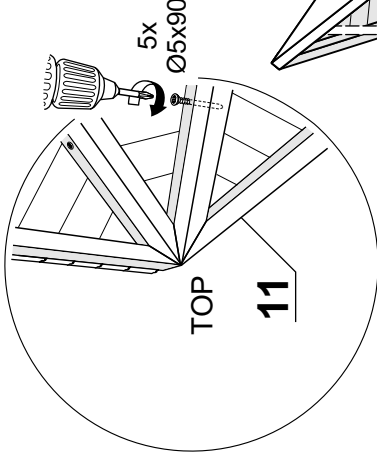
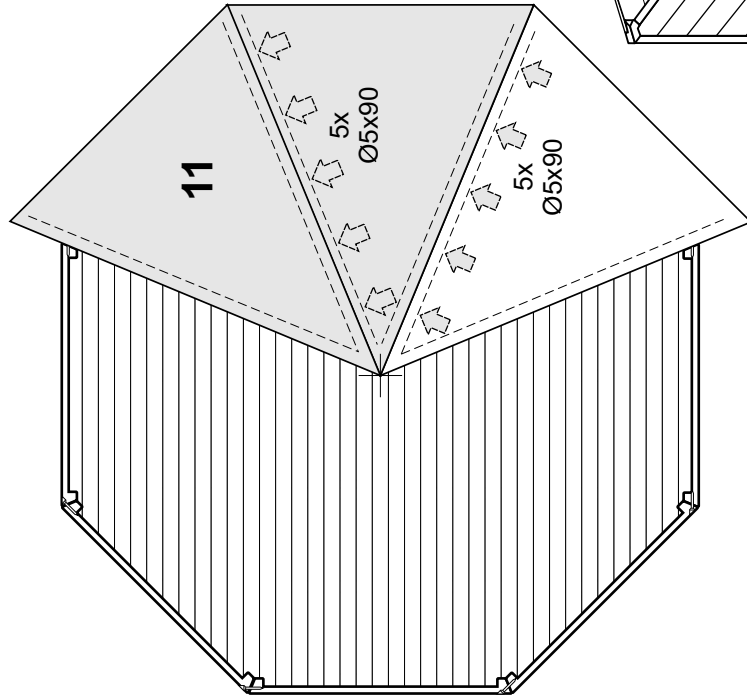

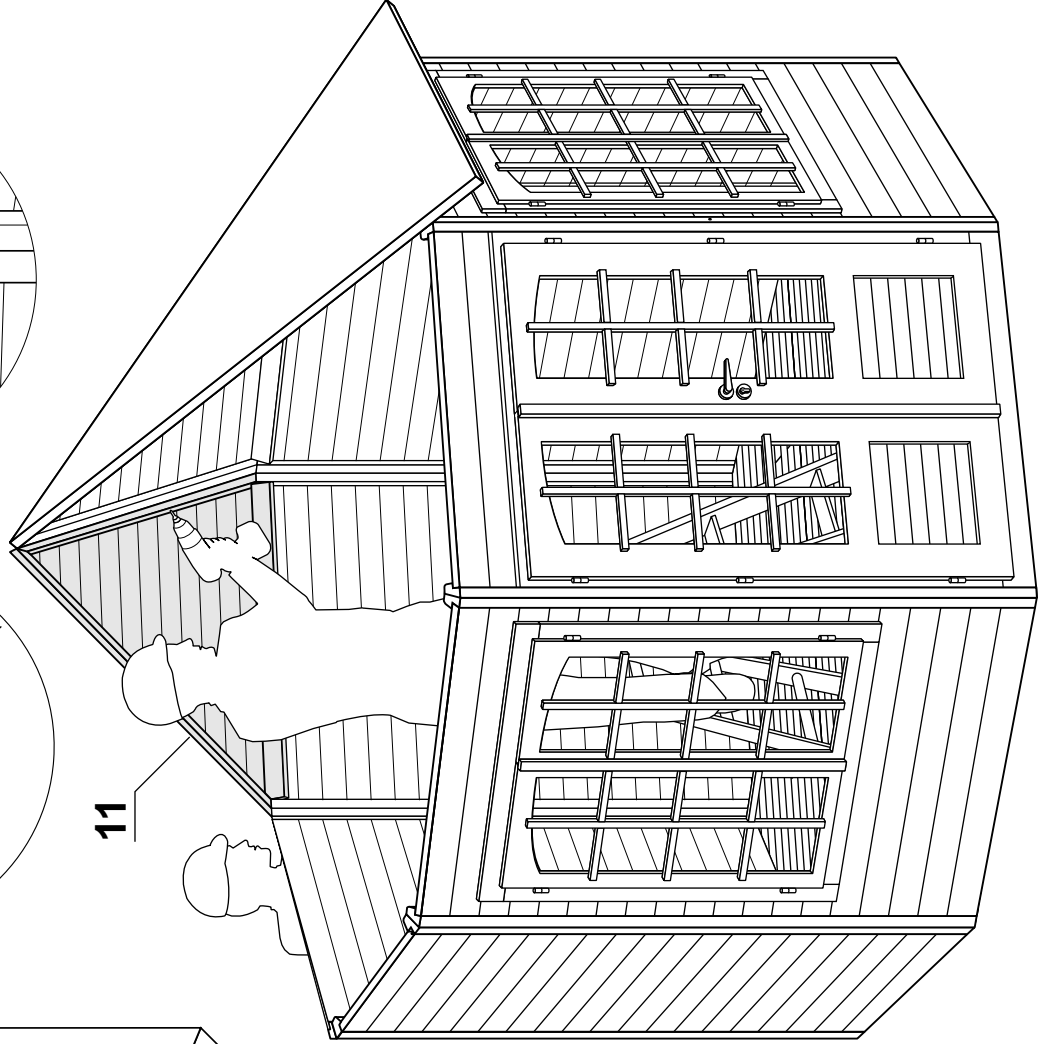
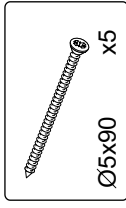
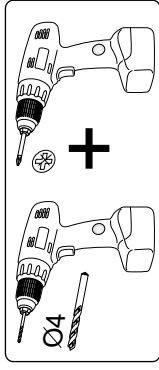
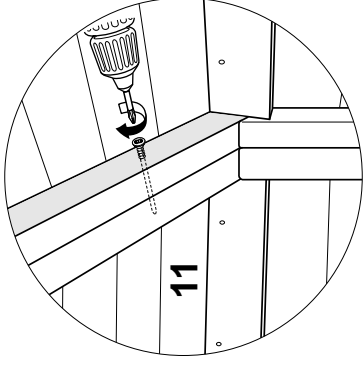
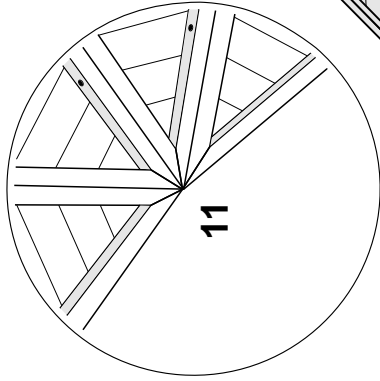
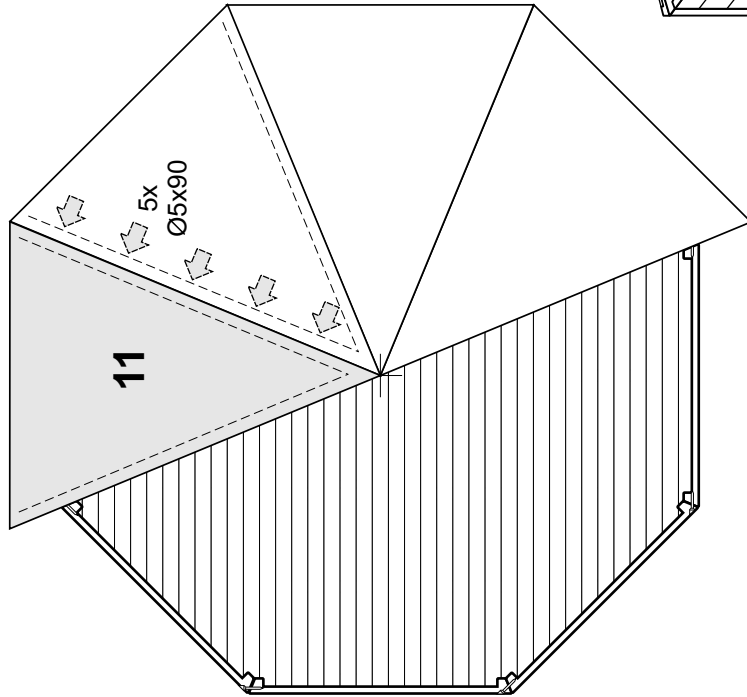

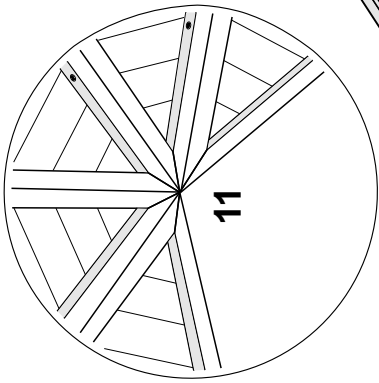
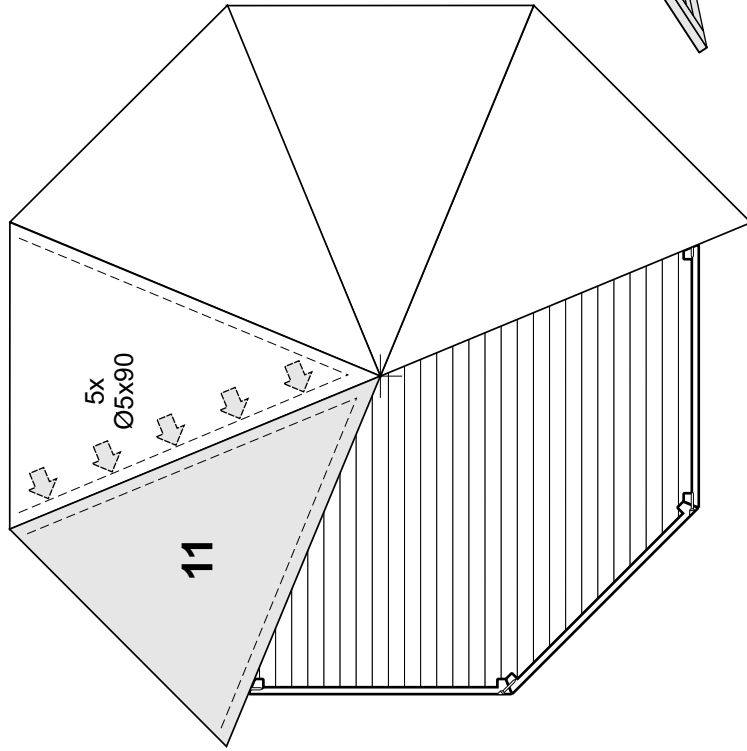

5x
Ø5x90

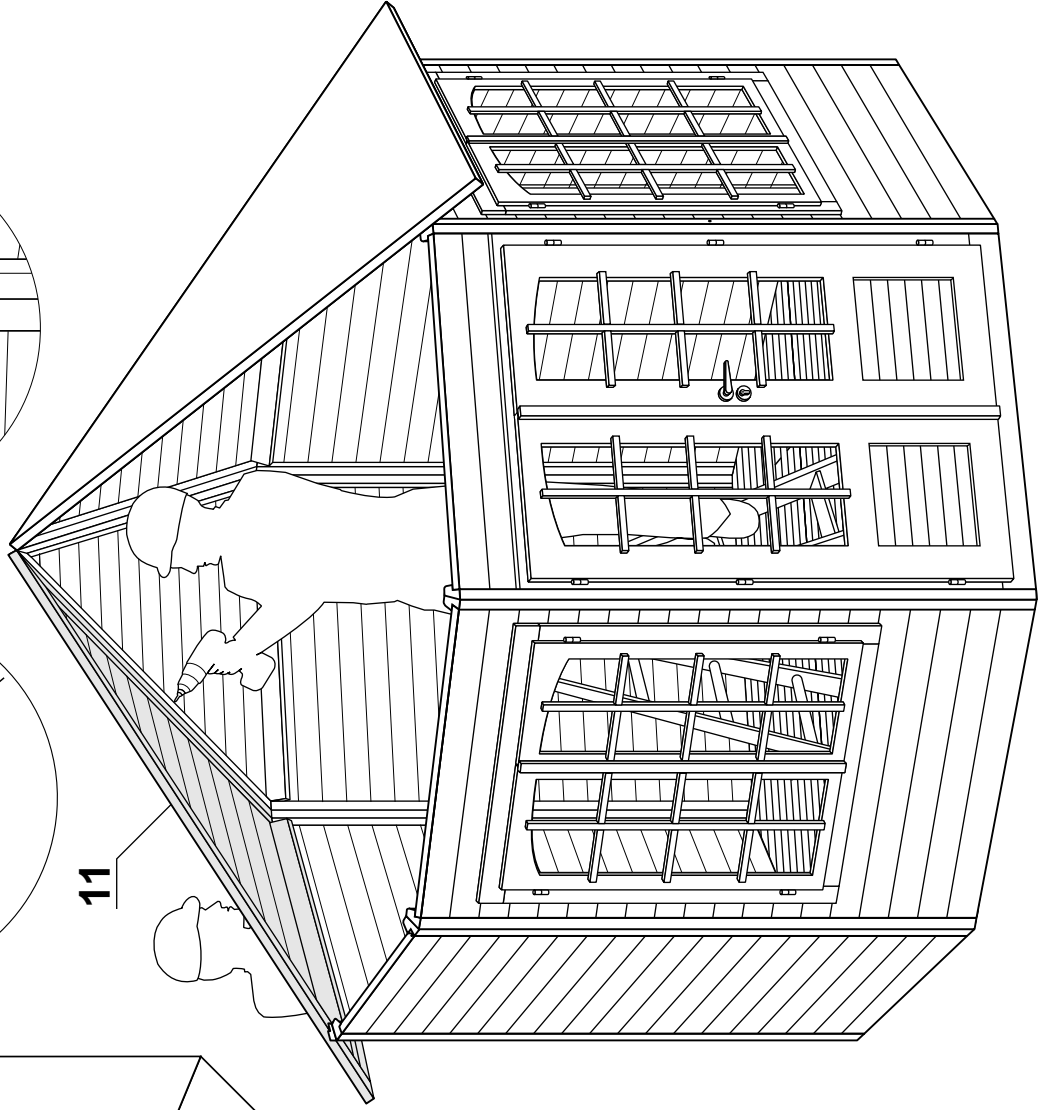
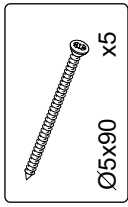
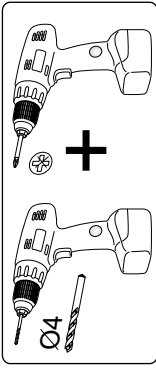
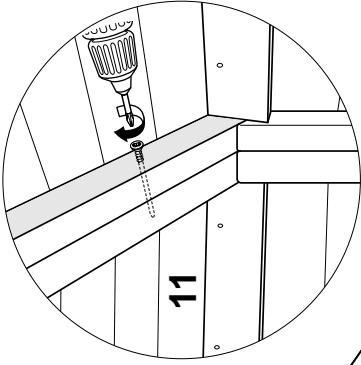

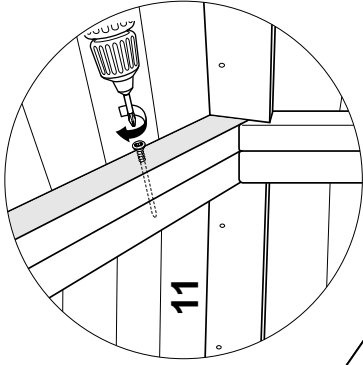
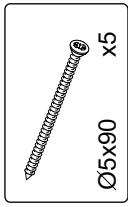
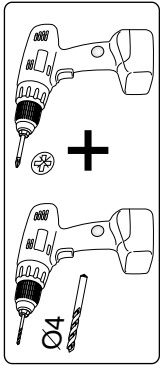

5x
Ø5x90

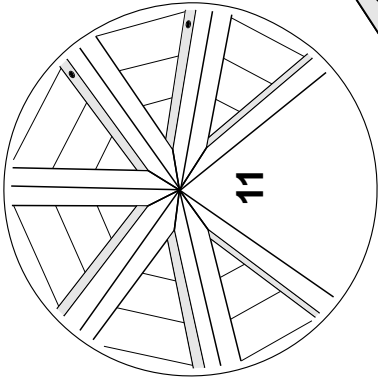

11

11

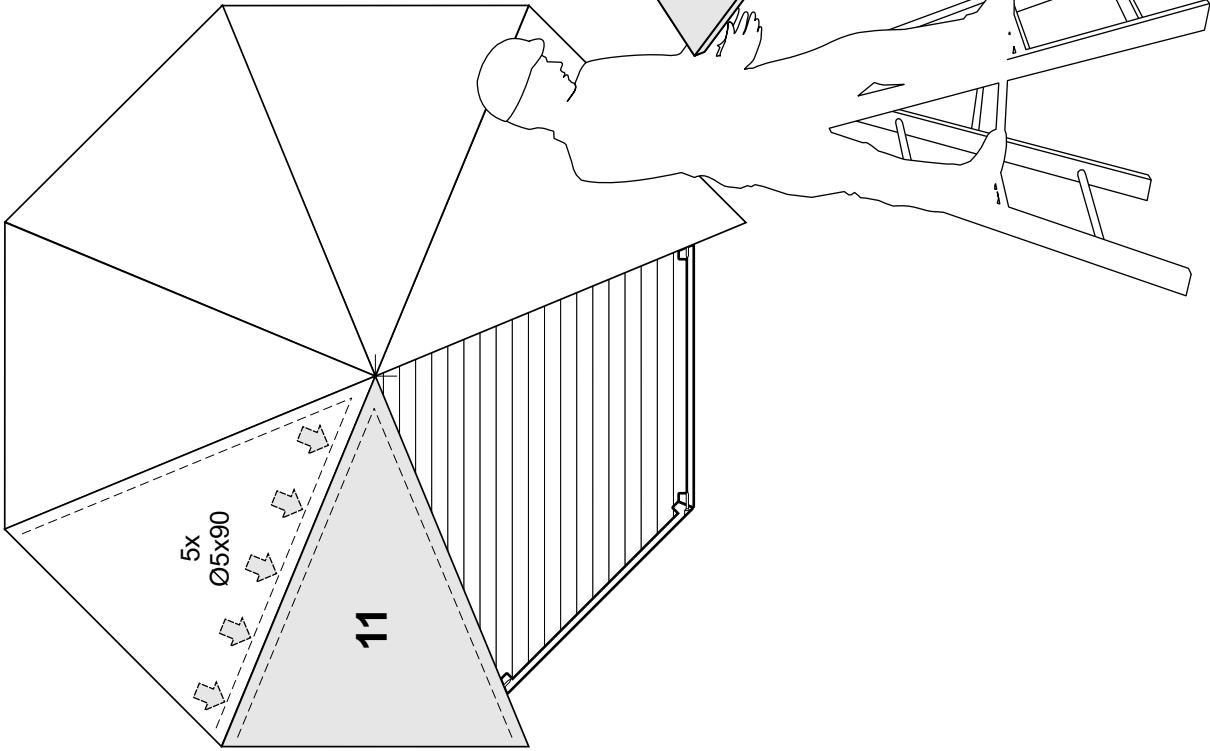

5x
Ø5x90

11

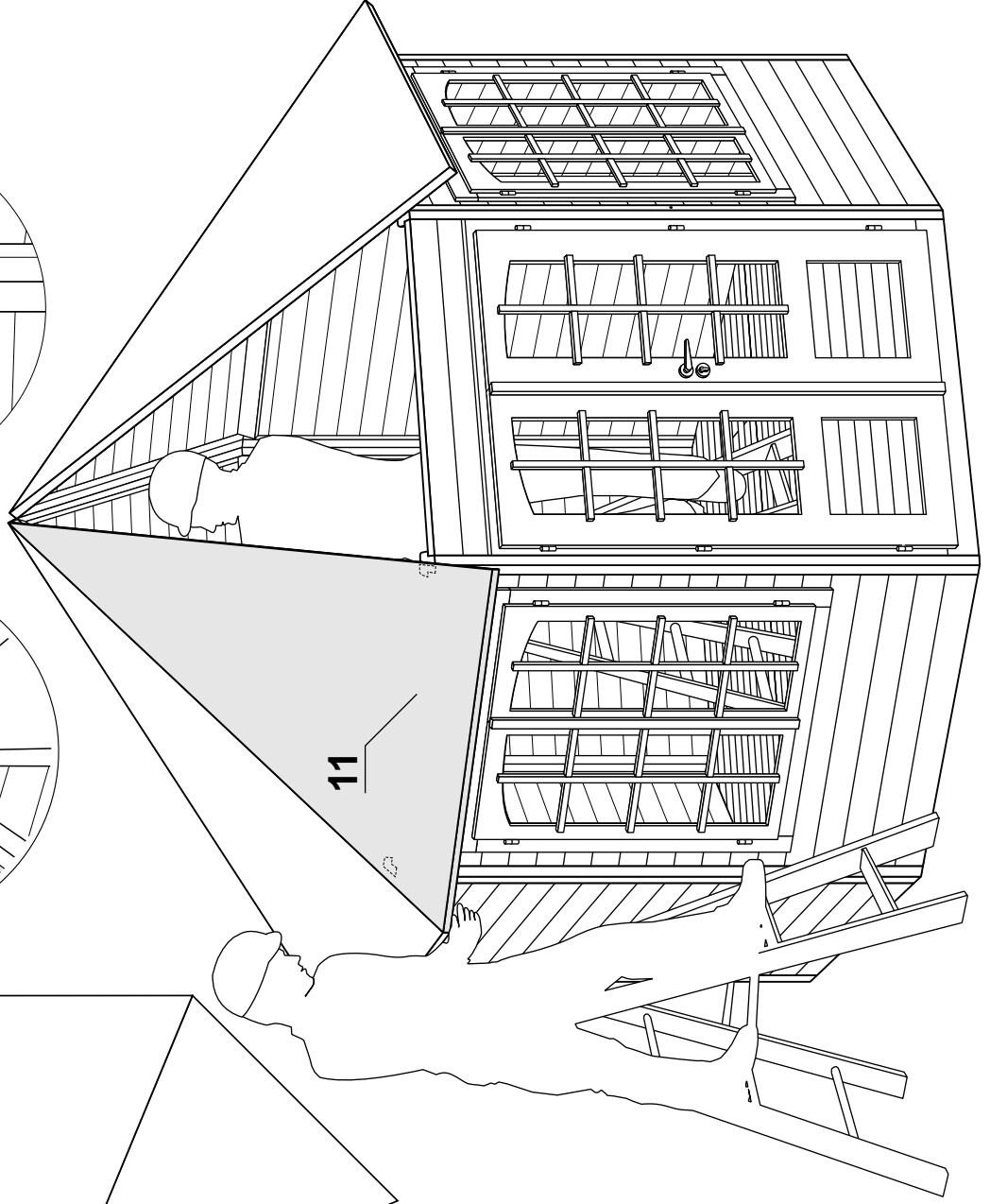
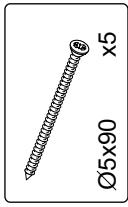
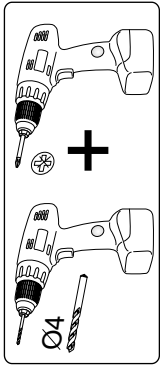
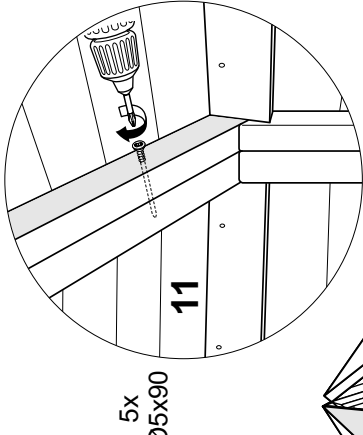
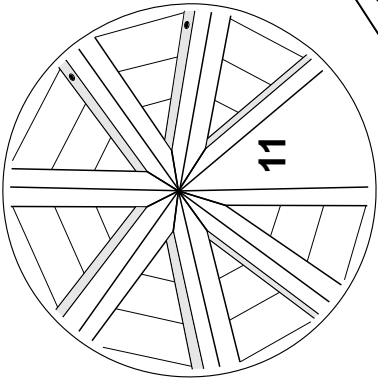
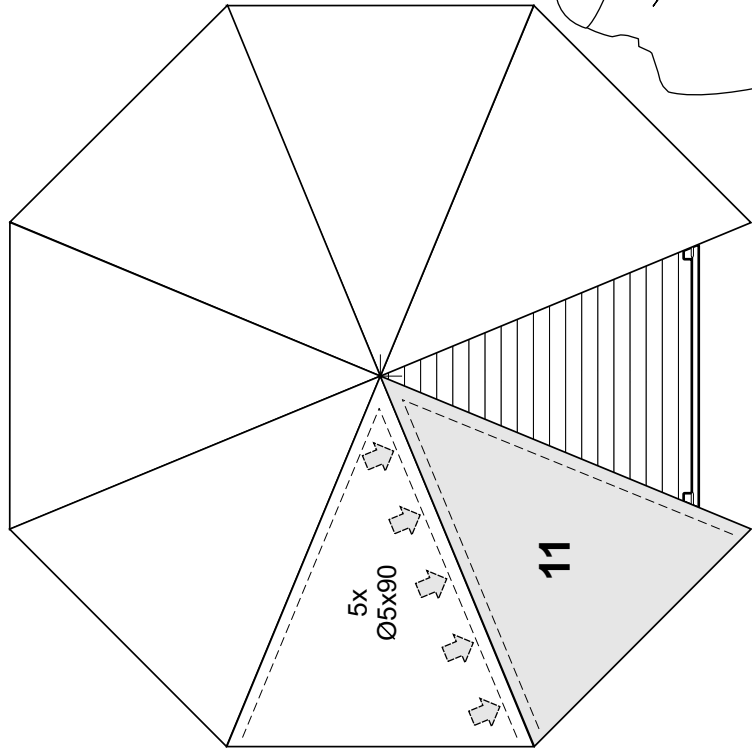

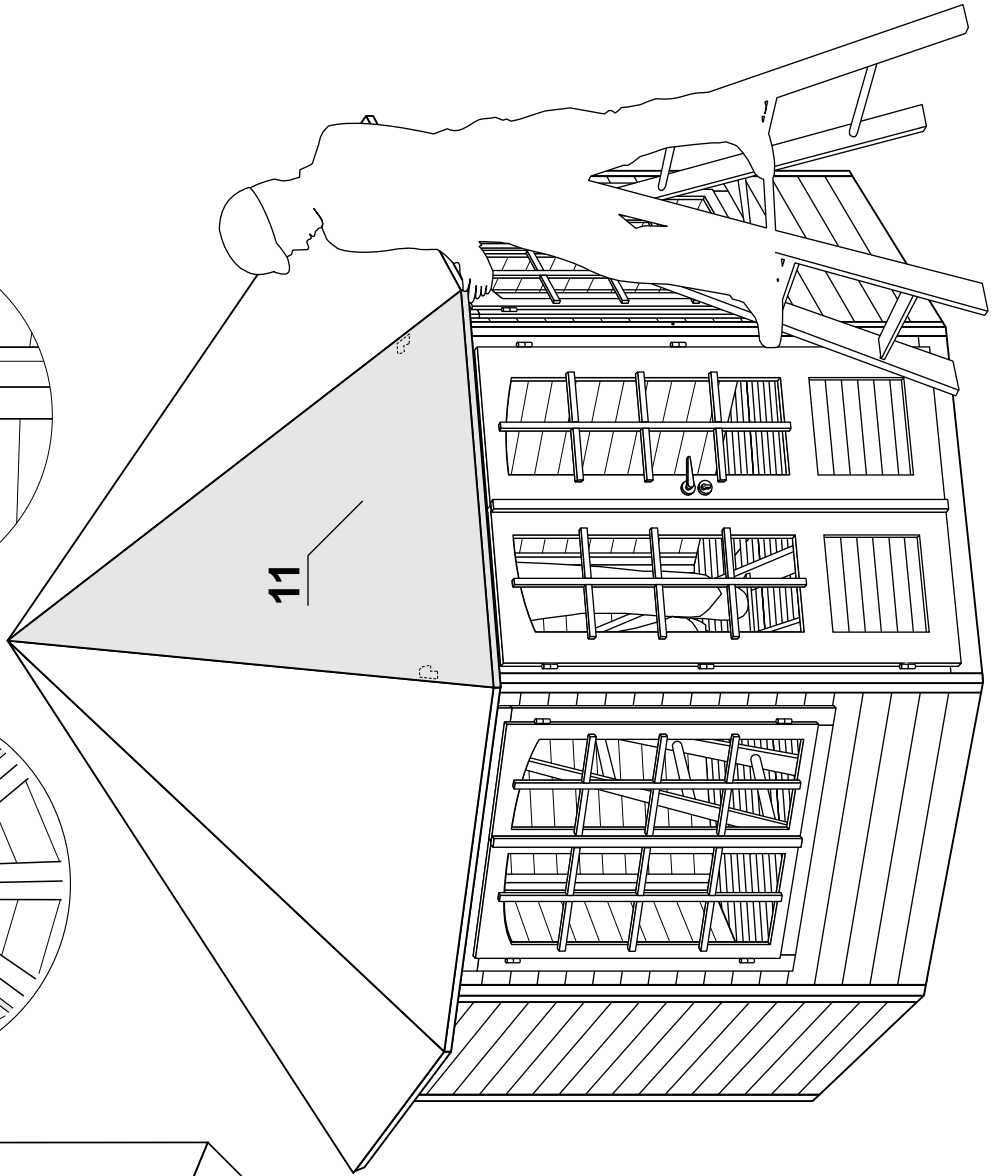
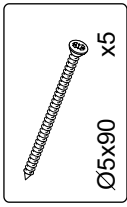
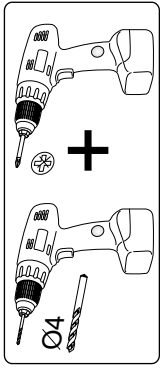
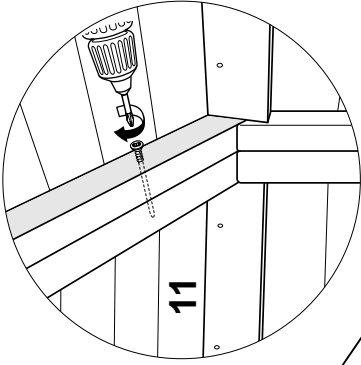
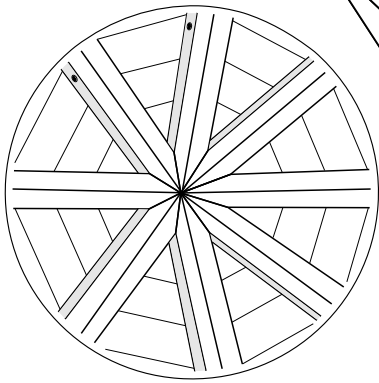
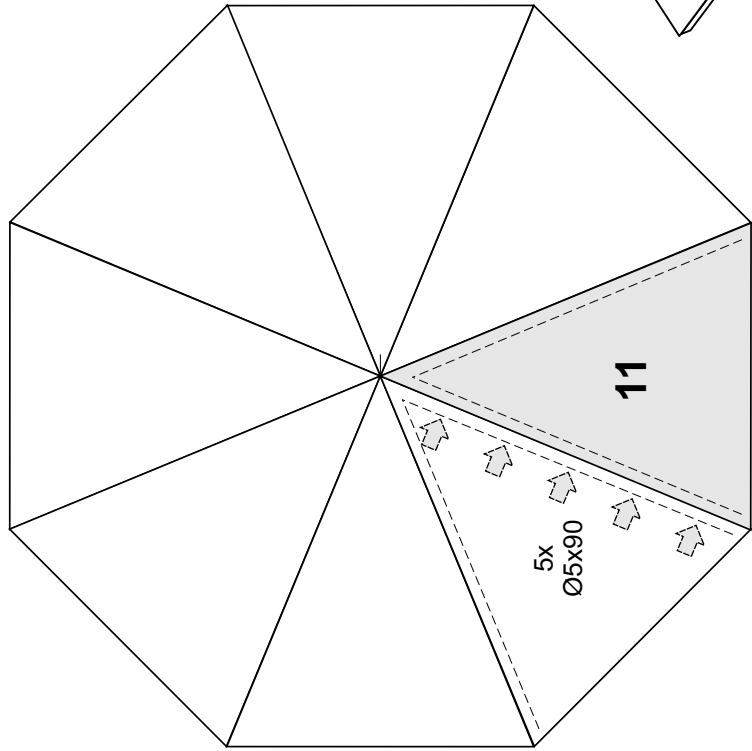

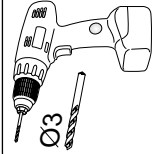
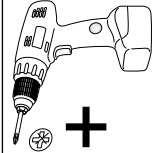
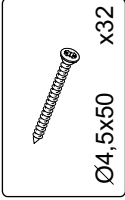
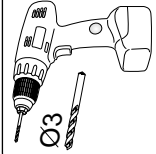
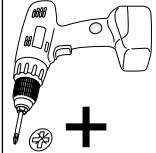
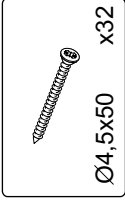
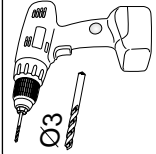
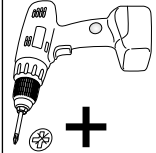
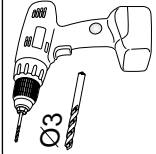
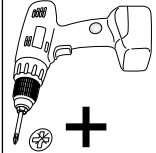
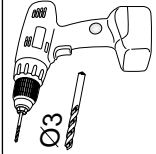
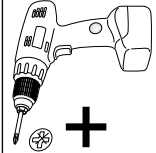
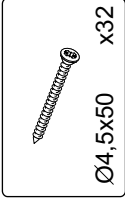
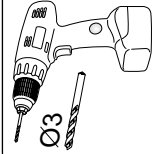
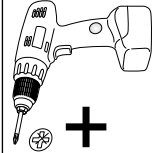
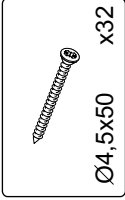
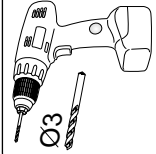
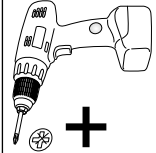
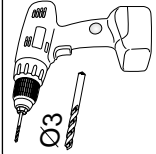
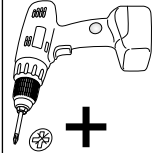
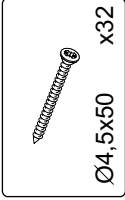
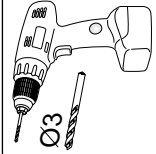
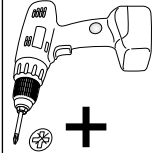
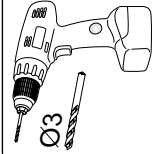
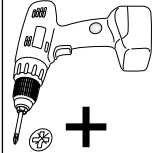
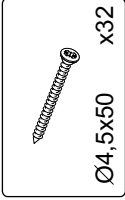
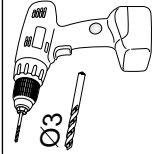
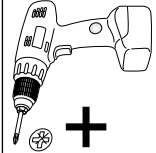
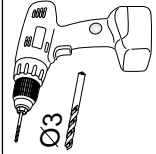
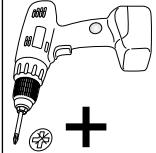
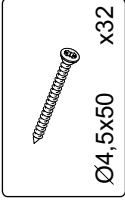
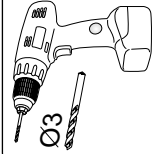
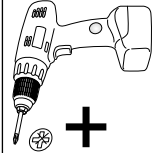
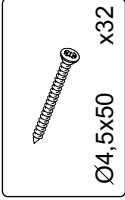
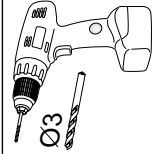
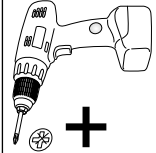
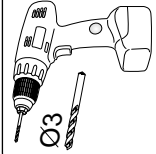
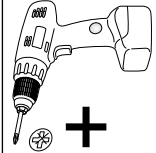
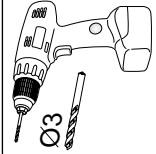
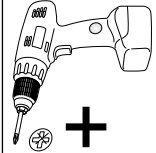
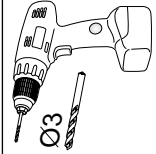
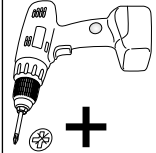
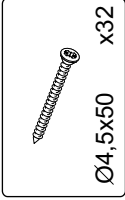
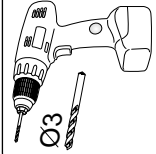
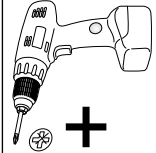
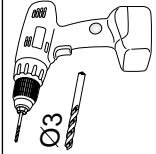
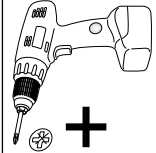
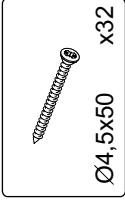
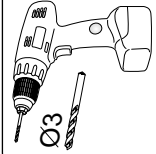
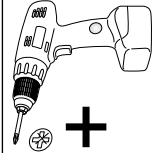
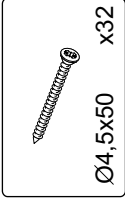
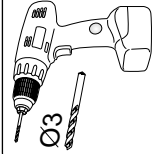
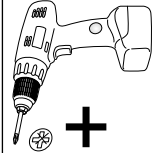
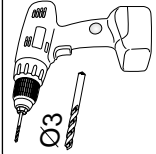
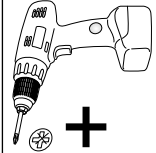
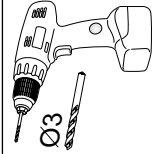
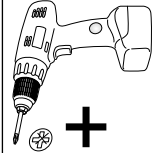
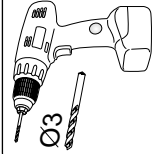
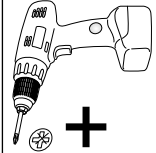
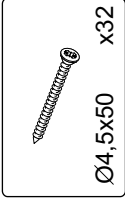
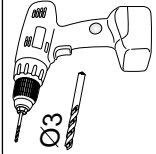
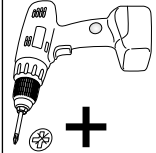
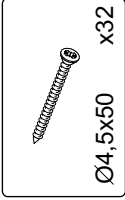
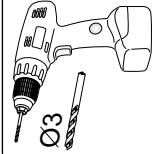
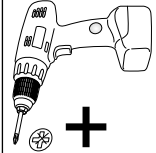
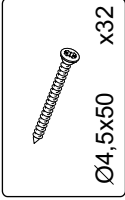
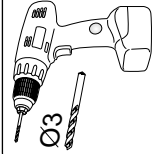
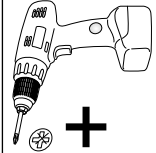
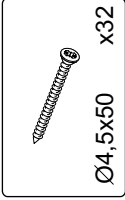
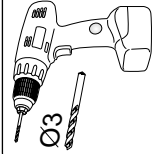
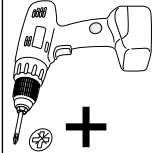
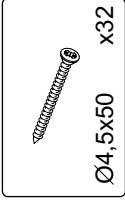
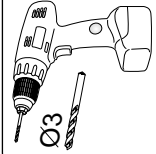
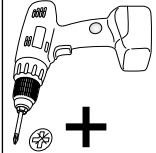
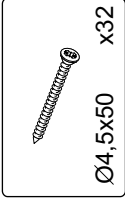
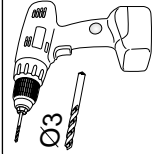
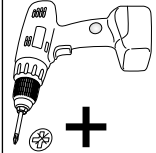
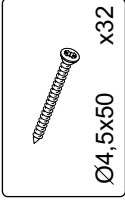
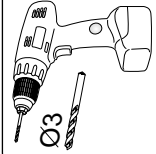
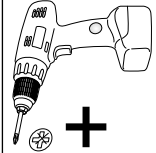
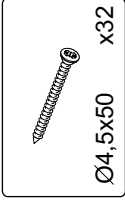
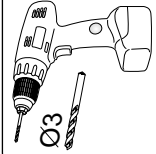
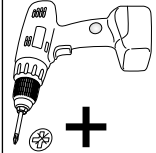
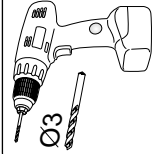
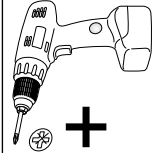
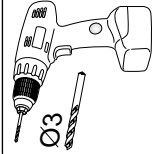
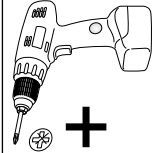
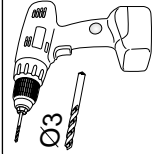
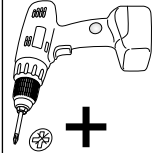
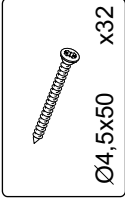
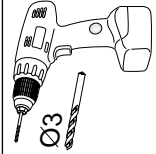
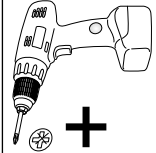
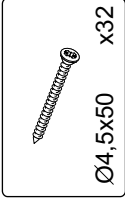
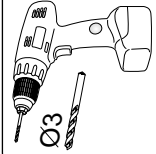
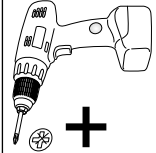
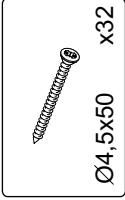
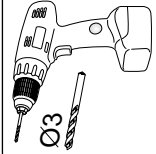
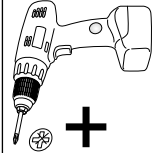
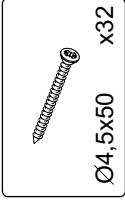
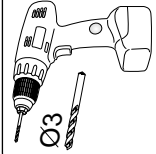
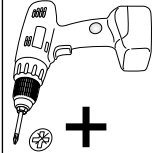
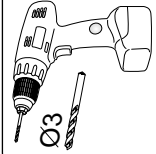
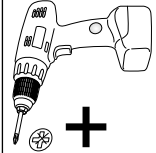
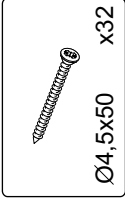
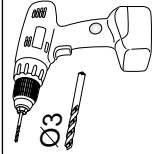
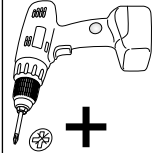
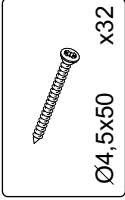
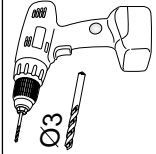
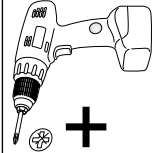
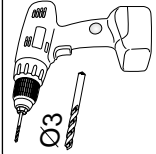
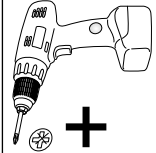
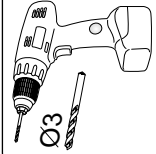
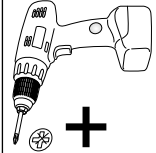
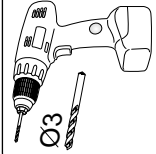
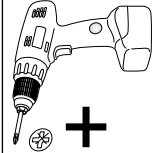
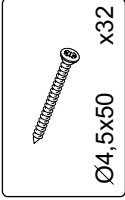
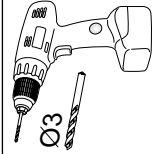
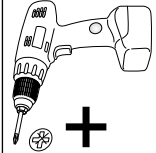
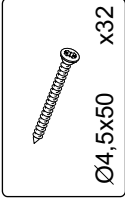
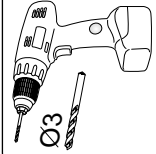
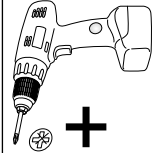
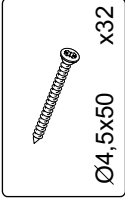
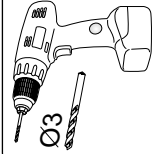
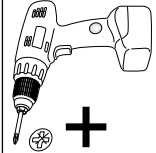
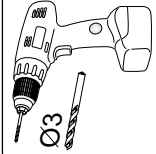
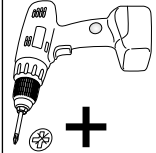
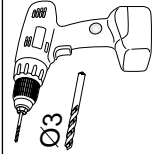
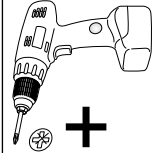
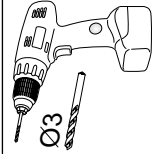
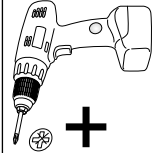
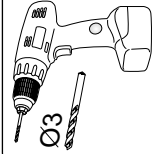
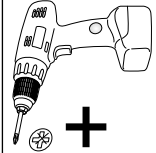
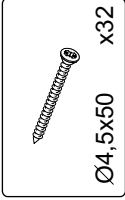
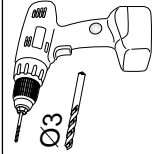
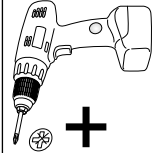
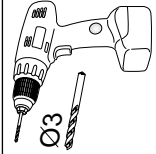
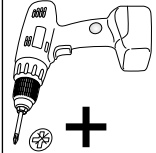
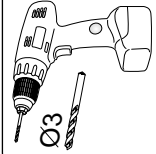
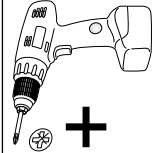
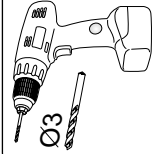
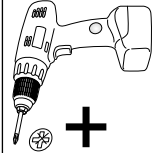
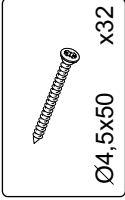
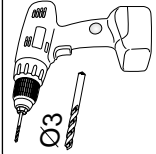
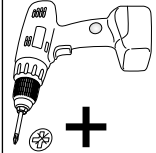
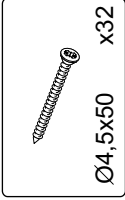
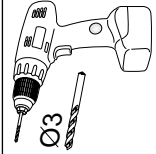
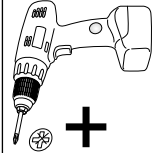
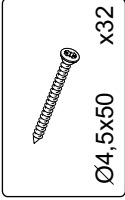
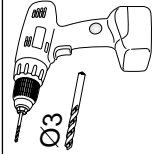
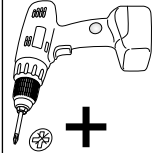
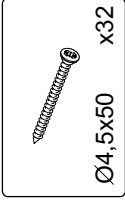
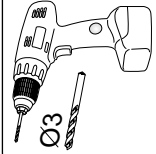
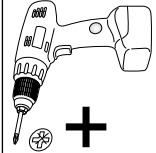
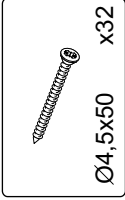
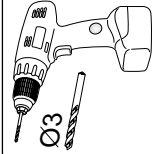
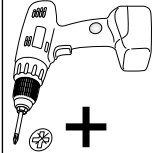
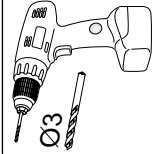
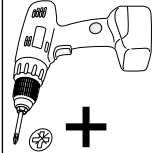
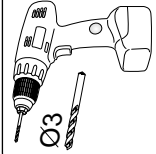
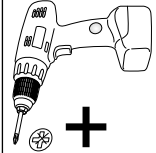
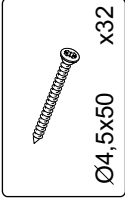
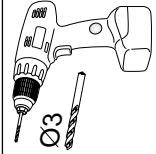
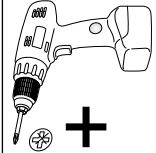
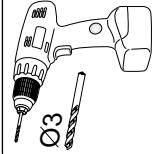
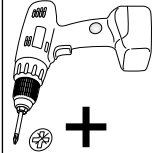
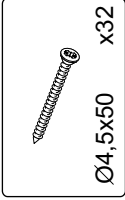
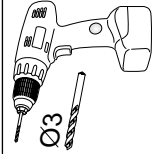
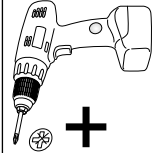
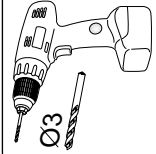
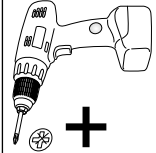
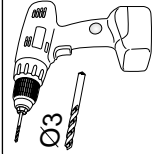
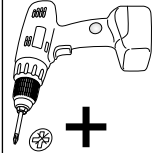
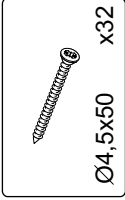
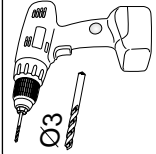
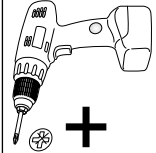
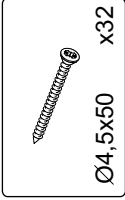
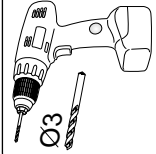
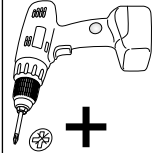
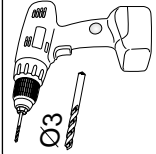
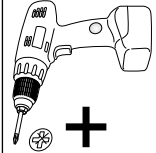
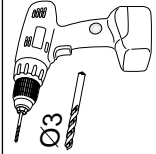
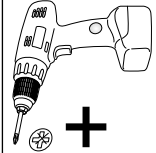
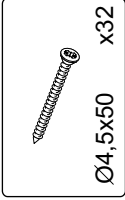
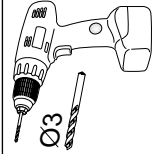
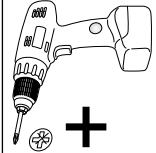
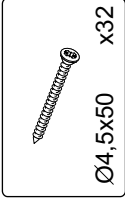
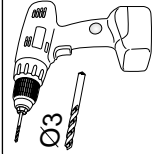
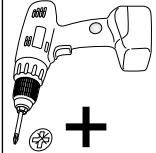
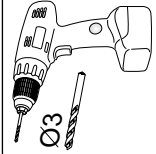
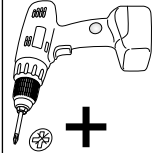
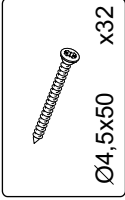
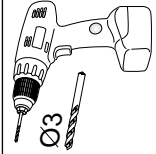
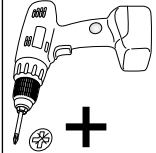
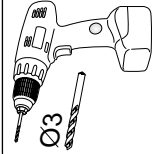
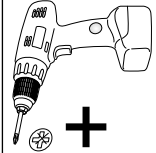
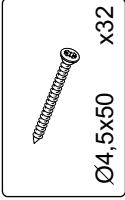
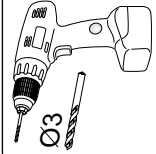
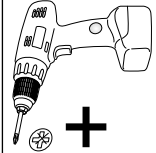
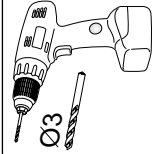
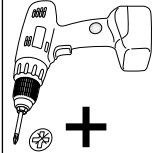
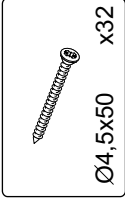
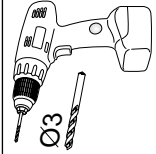
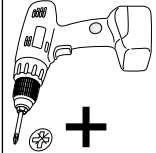
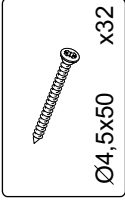
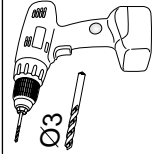
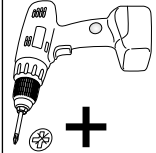
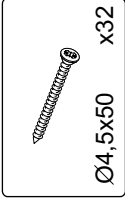
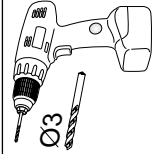
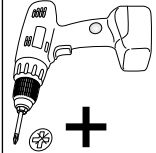
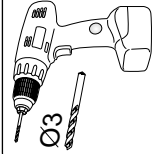
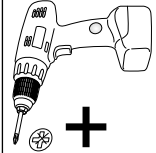
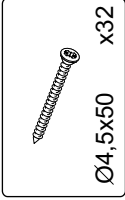
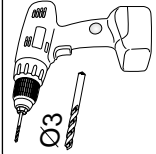
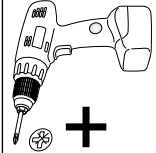
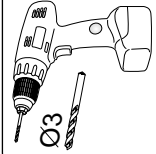
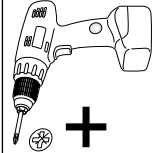
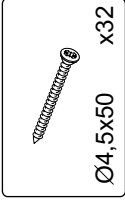
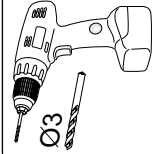
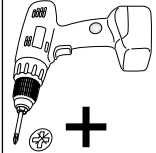
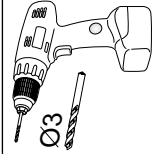
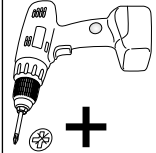
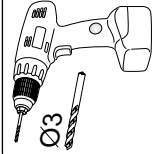
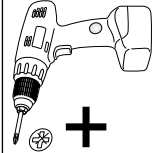
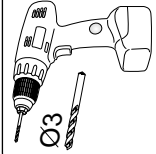
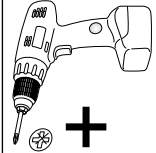
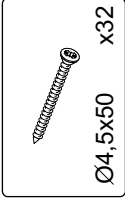
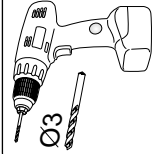
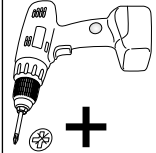
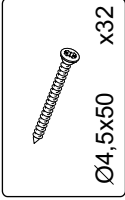
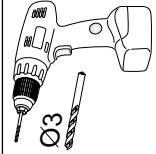
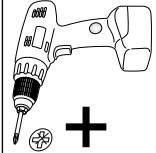
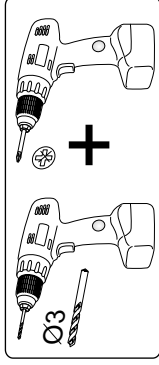
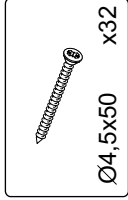
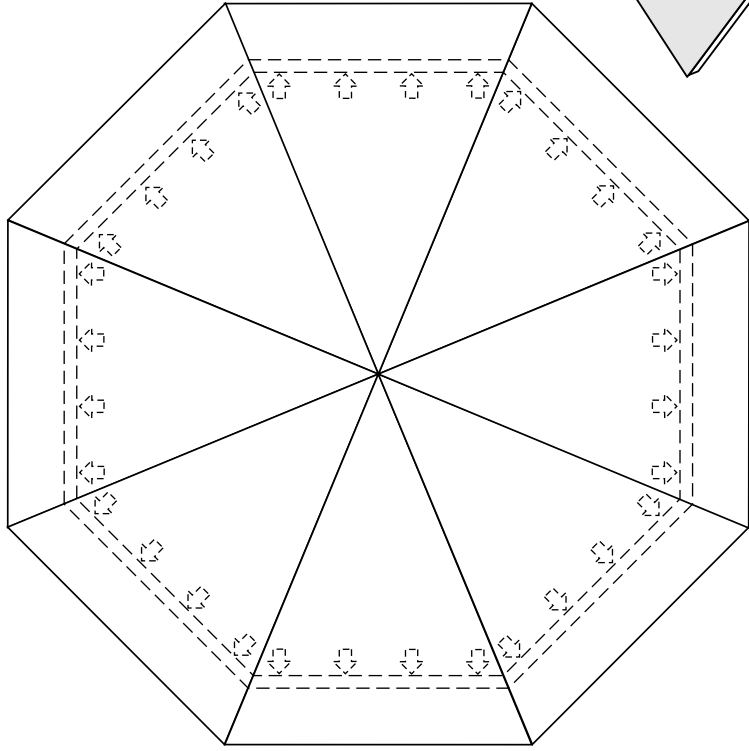

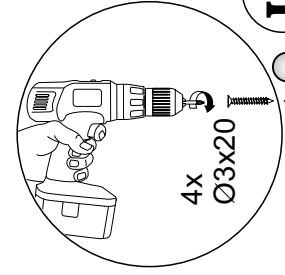
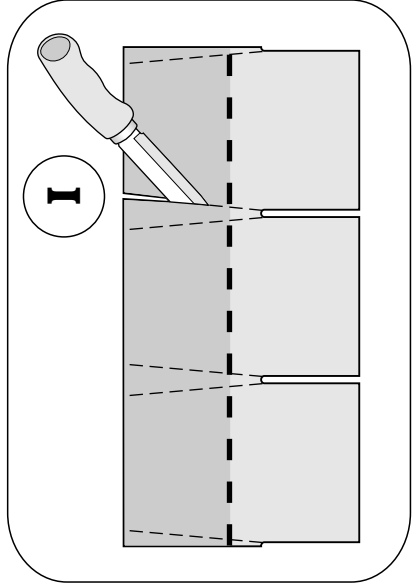
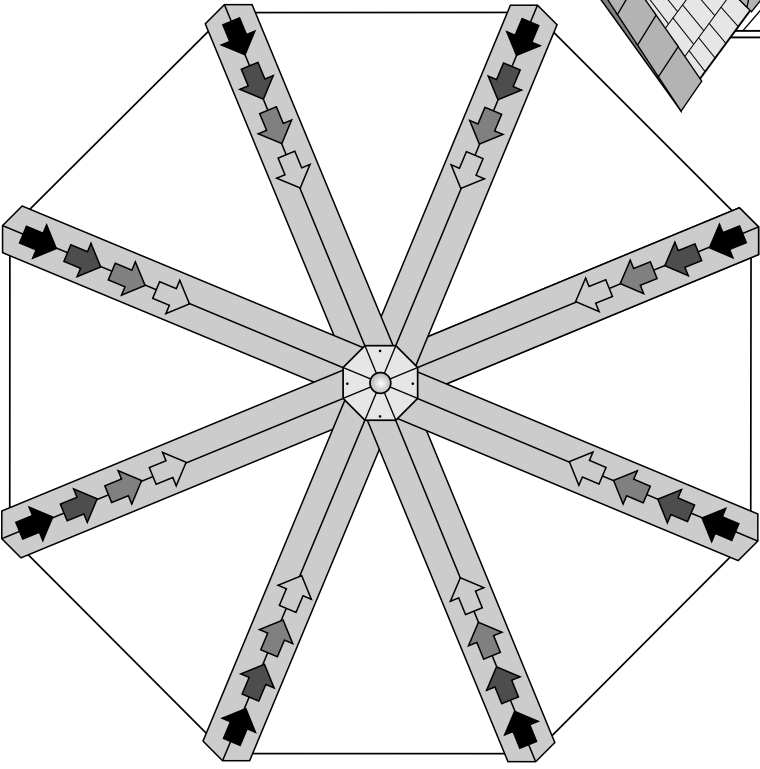

III

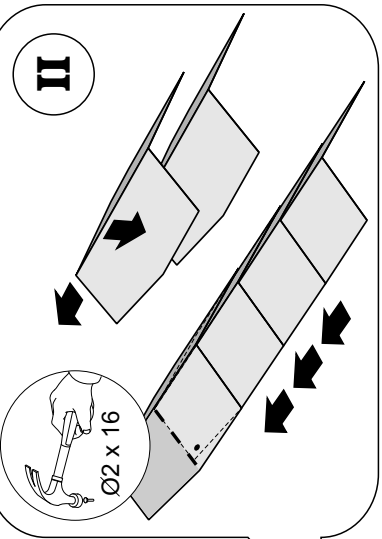
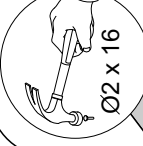

II

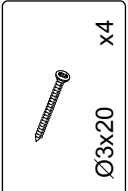
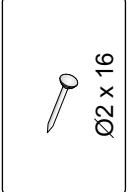
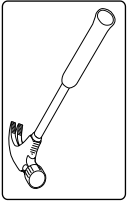
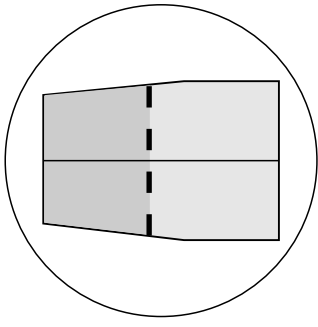

Ø3x20 x4

Ø2 x 16

4x
Ø3x20

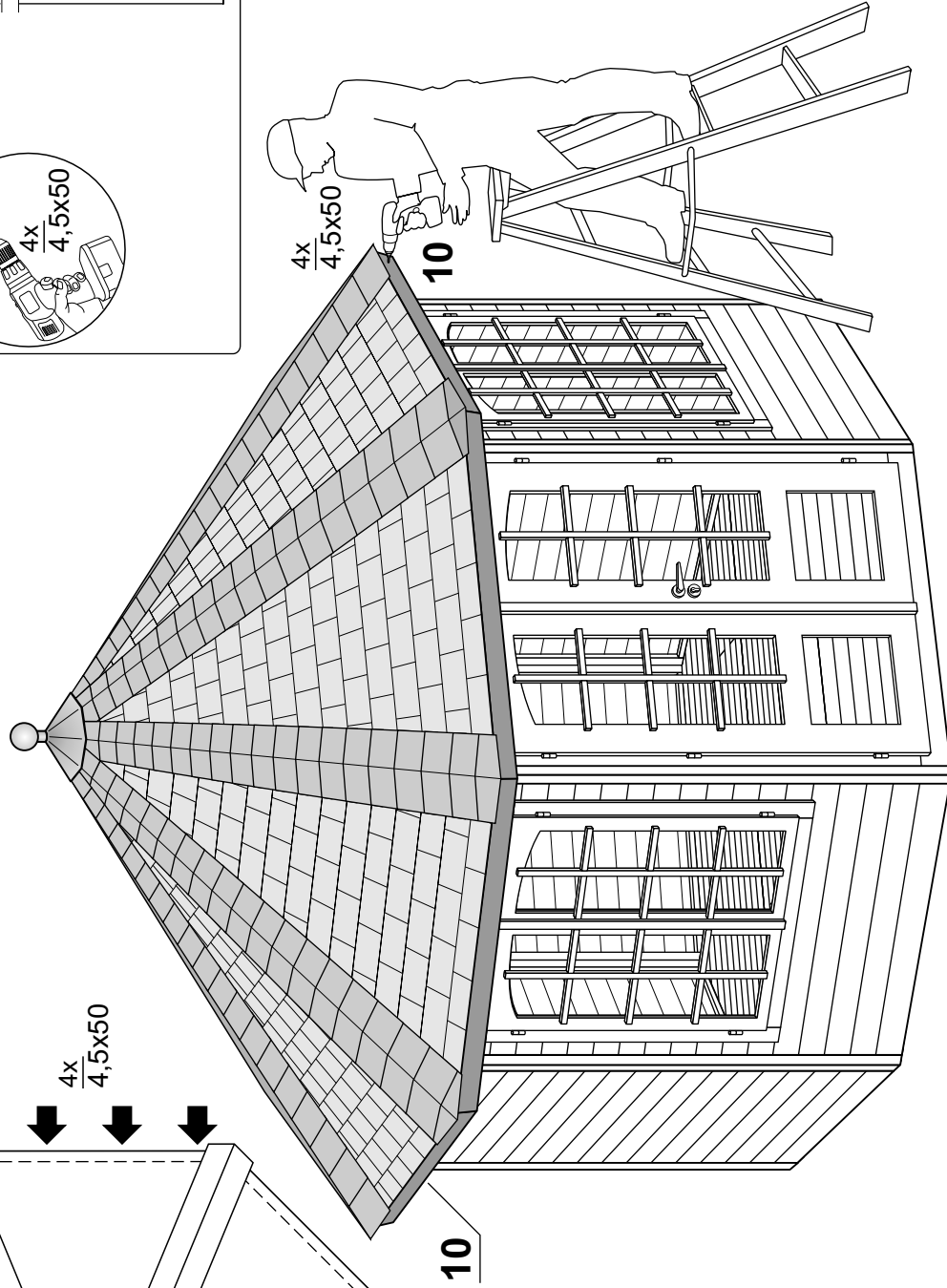
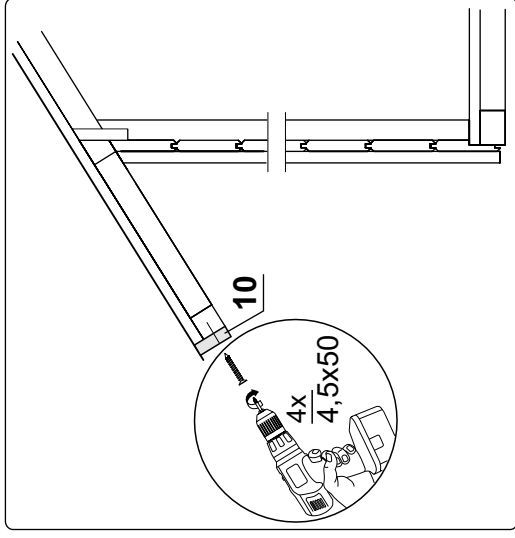
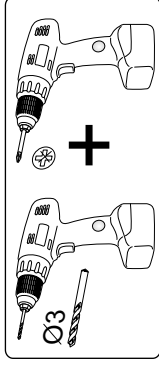
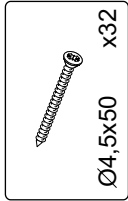
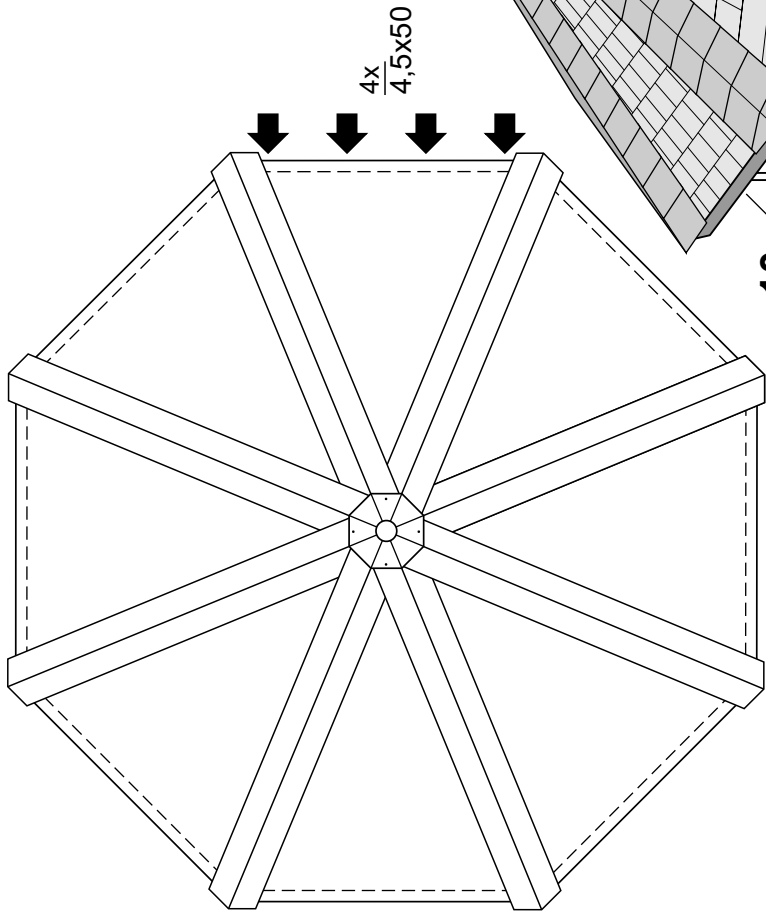

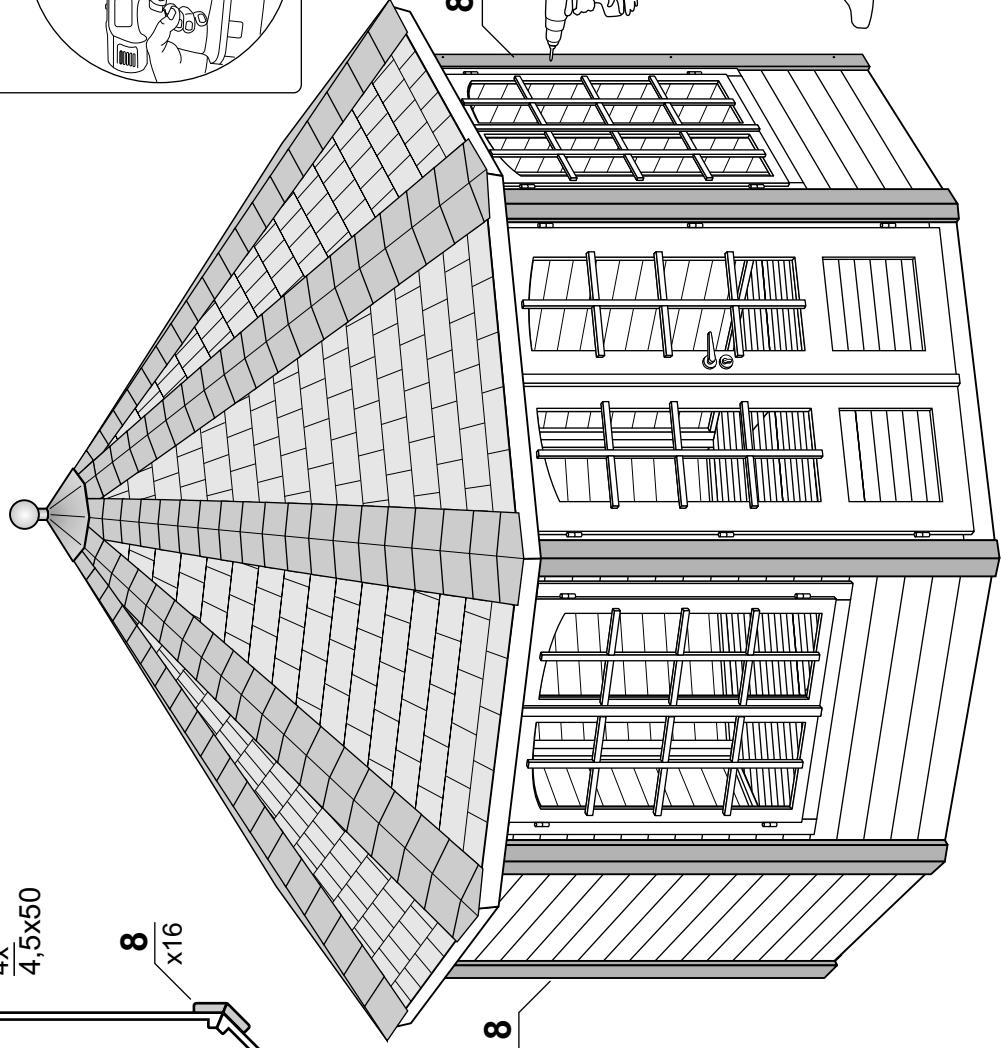
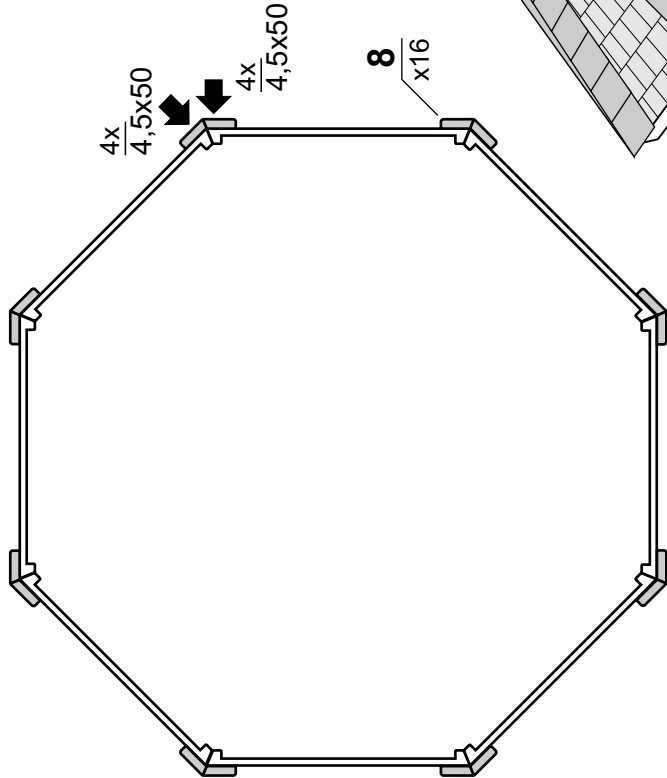
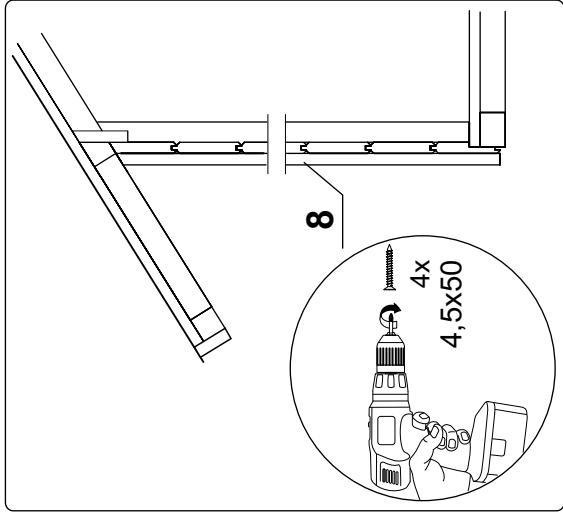
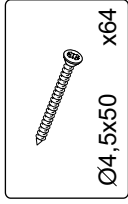
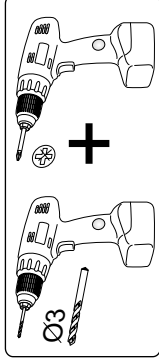

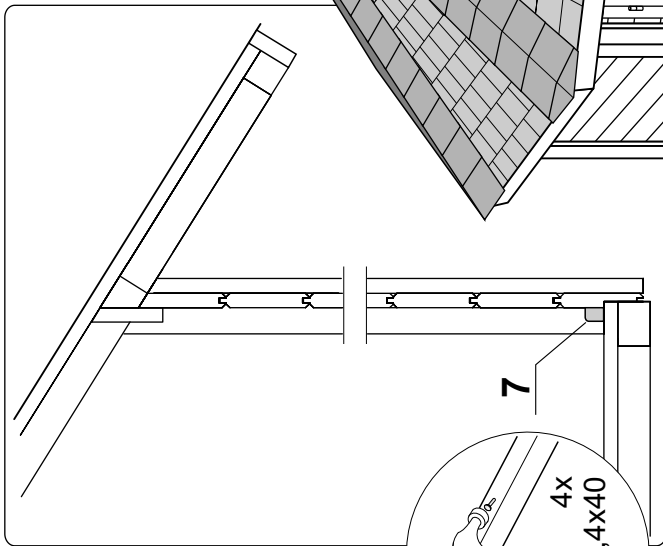
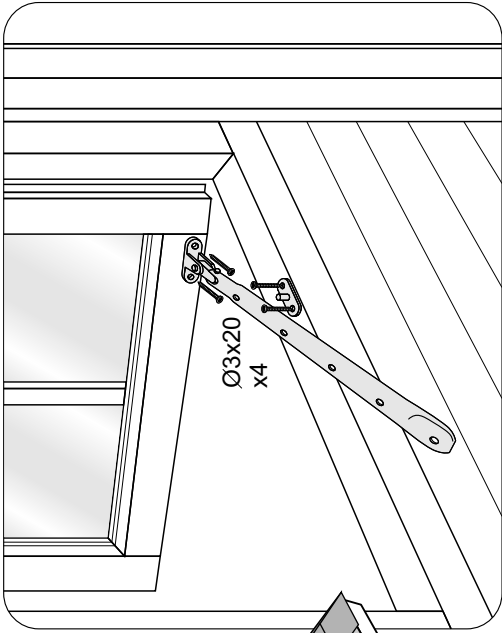
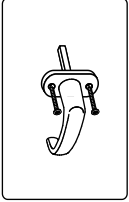
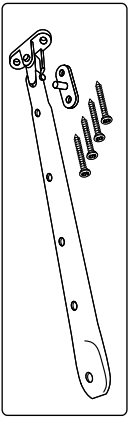

7

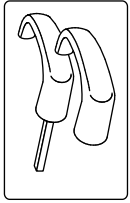
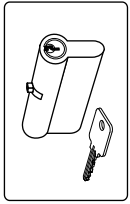
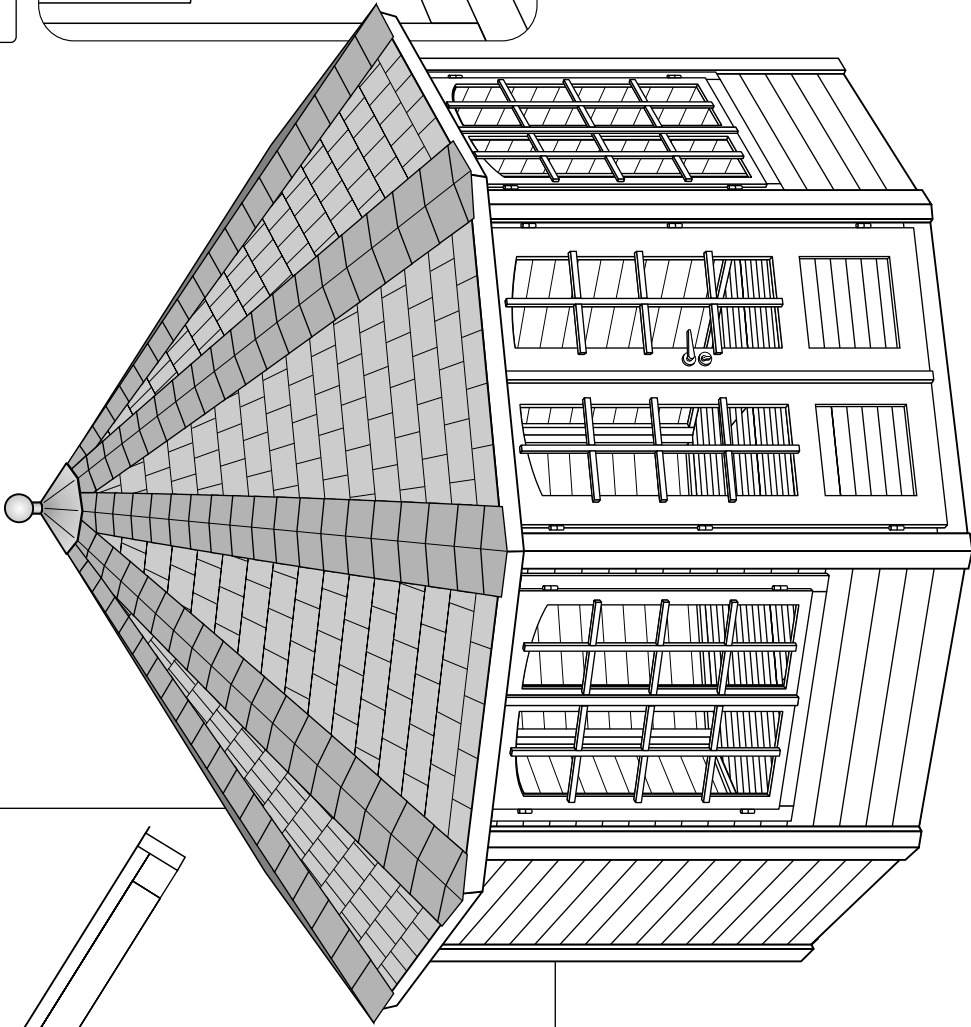
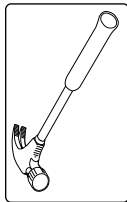
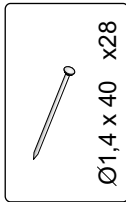

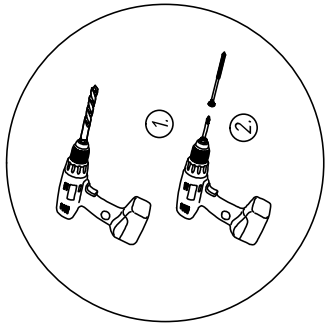
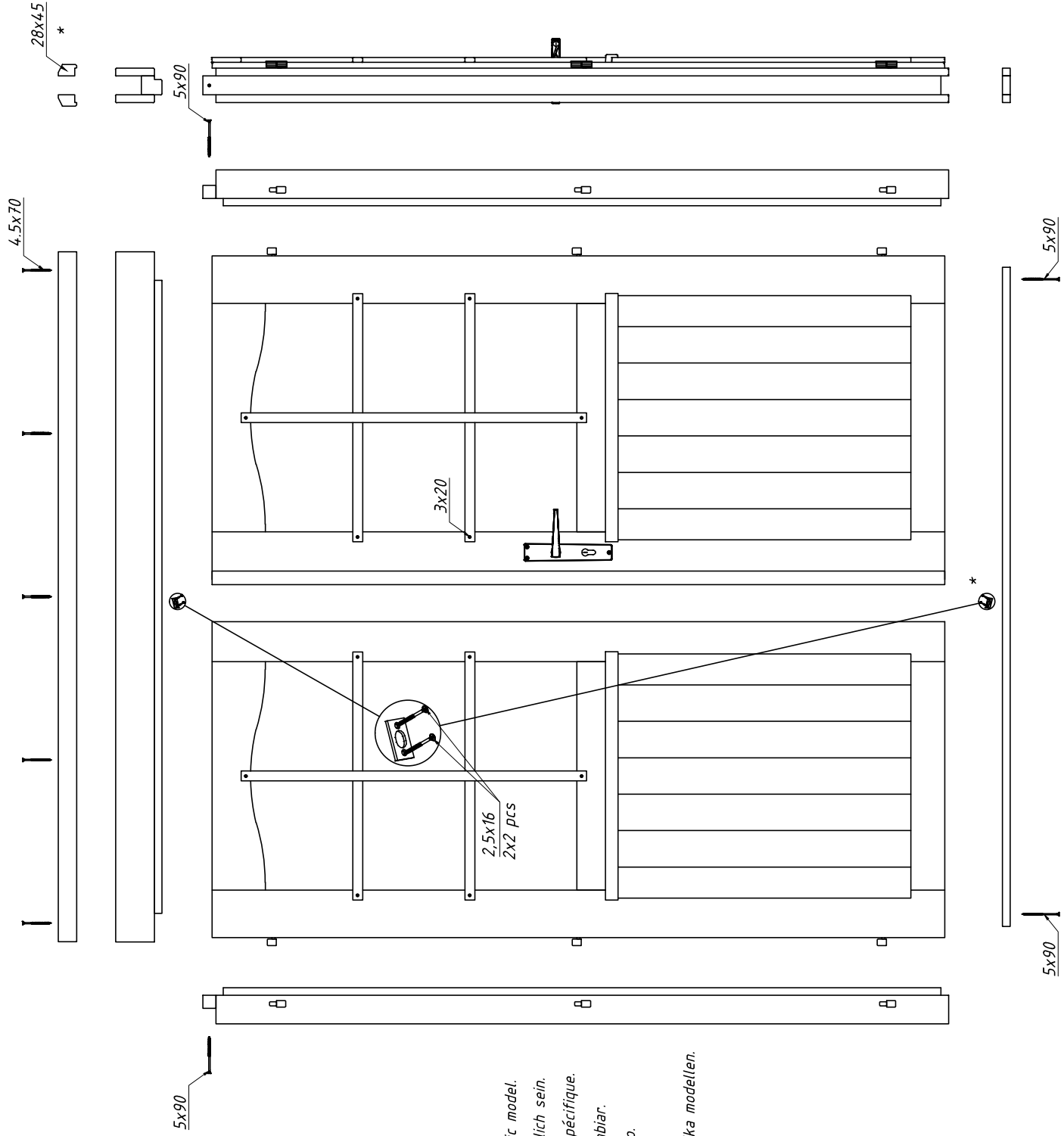

- * The specification may vary depending on the specific model.
- * Die Spezifikation können je nach Modell unterschiedlich sein.
- * Les spécifications peuvent varier selon le modèle spécifique.
- * Dependiendo del modelo, la especificación puede cambiar.
- * Le specifiche possono variare a seconda del modello.
- * Tekniset tiedot voivat vaihdella mallista riippuen.
- * Specifikationen kan variera beroende på den specifika modellen.

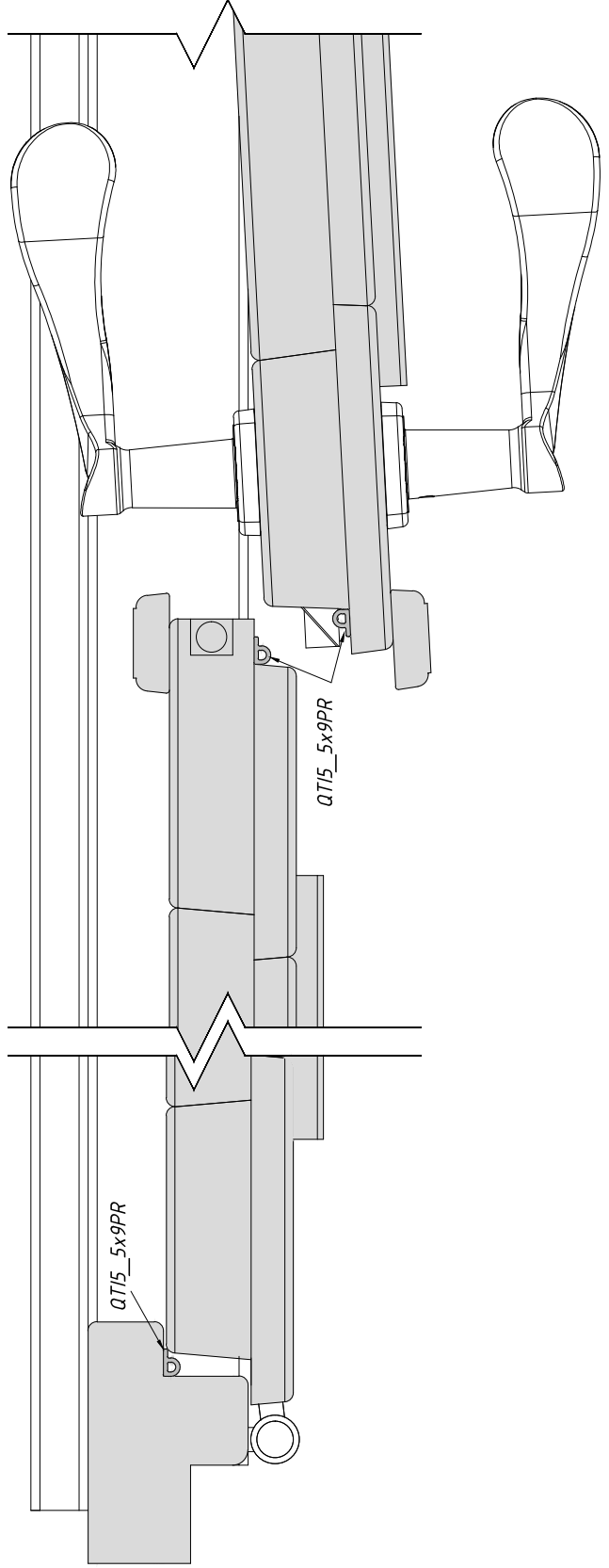
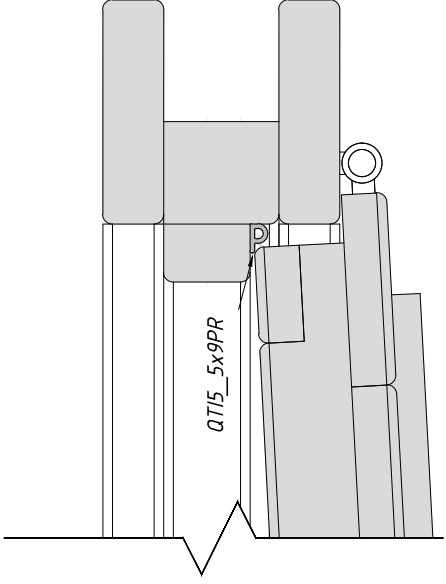
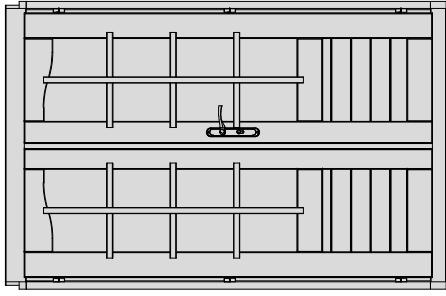
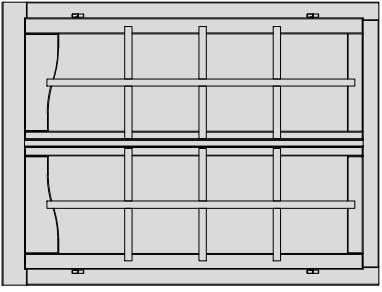

1 General information



Dear client,

We are glad that you have decided in favour of our garden house!

Please read the assembly manual carefully before proceeding with the house installation! You will thus avoid problems and will not waste time.

Recommendations:

- Keep the house package until its complete assembly in a dry place, but not in direct contact with the ground, protected from weather conditions (moisture, the sun, etc.). Do not keep the house package in a heated room!
- When selecting the garden house location, make sure that the house will not be subjected to extreme weather conditions (areas of strong snowfall or winds); otherwise you should attach the house (for instance, with anchors) to the subsoil.



Warranty

Your house is made from high quality spruce and delivered in the natural (unprocessed) form. If, despite our thorough inspection, you should have complaints, please submit the filled out control sheet and purchase invoice to the product seller.

ATTENTION: Please be sure to keep the documentation accompanying the house package! The control sheet includes the control number of the house. We can only review complaints if you submit the control number of the house to the seller!

The warranty does not cover:

- Peculiarities of wood as a natural material
- Wooden details already painted (processed with a wood preservative)
- Wooden details containing whole branches that do not endanger the stability of the house
- Colour tone variations caused by wood structure differences that do not influence wood lifetime
- Wooden details containing (caused by drying) small cracks/gaps that do not pass through and do not influence the structure of the house
- Twisted wooden details if they can nevertheless be installed
- Roof and floor boards that may have on their concealed surfaces some non-planed areas, colour differences and waning
- Complaints resulting from an incompetent manner of the installation of the house or the house subsiding due to an incompetently made foundation
- Complaints caused by introducing self-initiative changes to the house, such as the deformation of wooden details and doors/windows due to an incompetent manner of wood processing; the attachment of storm braces too rigidly, doorframes being screwed onto wall logs, etc.

The complaints covered by the warranty are satisfied to the extent of replacing the deficient/faulty material. All other demands will be excluded!



Garden house painting and maintenance

Wood is a natural material, growing and adapting depending on weather conditions. Large and small cracks, colour tone differences and changes, as well as a changing structure of wood are not errors, but a result of wood growing and a peculiarity of wood as a natural material.

Unprocessed wood (except for foundation joists) becomes greyish after having been left untouched for a while, and can be turn blue and become mouldy. To protect the wooden details of your garden house, you must immediately process them with a wood preservative.

We recommend that you cover the floor boards in advance with a colourless wood impregnation agent, especially the bottom sides of the boards, to which you will no longer have access when the house is assembled. Only this will prevent moisture penetration.

We definitely recommend that you also process the doors and windows with a wood impregnation agent, and do that namely both inside and outside! Otherwise the doors and windows can become twisted.

After the house assembly is completed, we recommend for the conclusive finishing a weather protection paint that will protect wood from moisture and UV radiation.

When painting, use high quality tools and paints, follow the paint application manual and manufacturer's safety and usage instructions. Never paint a surface in strong sunlight or rainy weather. Consult a specialist regarding paints suitable for unprocessed softwood and follow the paint manufacturer's instructions.

Having been properly painted, your garden house's lifetime will increase substantially. We recommend that you inspect the house thoroughly once every six months.

2 Preparation for assembly

Tools and preparation of components

To assemble the garden house, you will need the following tools:



assembly aid



ladder



hammer



water-level



screwdriver



saw



knife



measuring tape



pliers



drill

ADVICE: To avoid splinters, we recommend that you wear the corresponding protective gloves during the assembly process.



We wish you total success with the garden house installation and much joy with this house for many years to come!

1 Generelles



Sehr geehrter Kunde,

es freut uns, dass Sie sich für unser Gartenhaus entschieden haben!

Es ist wichtig, diese Aufbauanleitung vollständig durchzulesen, bevor Sie mit dem Aufbau Ihres Blockhauses beginnen! So vermeiden Sie Probleme und unnötigen Zeitverlust.

Tipps:

- Lagern Sie den Bausatz bis zur endgültigen Montage trocken und nicht direkt auf dem Erdboden, geschützt vor Witterungseinflüssen (Nässe, Sonneneinwirkung, etc.). Ware bitte nicht in einem geheizten Raum aufbewahren!
- Achten Sie bei der Standortwahl darauf, dass das Blockhaus nicht extremen Witterungsbedingungen (Gebiete mit starkem Wind) ausgesetzt ist, gegebenenfalls sollten Sie das Blockhaus zusätzlich mit dem Fundament verankern.



Gewährleistung

Ihr Haus besteht aus hochwertigem nordischen Fichtenholz und wird unbehandelt geliefert. Wenn es trotz unserer sorgfältigen Werkskontrolle zu Reklamationen kommen sollte, legen Sie Ihrem Fachhändler den ausgefüllten Kontrollschein mit Ihrer Einkaufsrechnung vor!

WICHTIG: Bitte unbedingt die Dokumentation aufbewahren! Auf dem Kontrollschein finden Sie die Kontrollnummer des Hauses. Es ist möglich die Reklamation nur dann als Garantiefall zu behandeln, wenn Sie die Kontrollnummer Ihrem Fachhändler weitergeben!

Abweichungen die keinen Reklamationsgrund darstellen:

- Holz ist ein Naturprodukt, daher gehören die naturgegebenen Beanstandungen nicht unter Garantie.
- Materialreklamationen werden nicht akzeptiert, wenn bereits ein Anstrich erfolgte!
- Äste die mit dem Holz fest verwachsen sind.
- Holzverfärbungen, ohne das dadurch die Lebensdauer beeinflusst wird.
- Risse /Trockenrisse die nicht durchgehend sind und nicht die Konstruktion beeinflussen.
- Verdrehungen des Holzes vorausgesetzt es lässt sich noch verarbeiten.
- An den nicht sichtbaren Seiten von Dach- und Fussbodenbrettern können die Bretter ungehobelt sein, es können Farbunterschiede und Baumkanten vorkommen.
- Spätere Reklamation durch unsachgemässe Montage, Absacken des Hauses durch unsachgemässe Fundamente und Gründungen sind ausgeschlossen.
- Eigene Veränderungen am Haus wie z.B. Verzug von Bohlen und Fenstern/Türen durch fehlenden Holzanstrich oder Aufbau, die zu starre Befestigung der Sturmleiste, Verschrauben der Türrahmen mit den Blockbohlen usw., sind ausgeschlossen.

Ansprüche auf Gewährleistung beschränken sich auf den Austausch von fehlerhaftem Material. Alle weiteren Ansprüche sind ausgeschlossen!



Anstrich und Pflege

Holz ist ein Naturprodukt und arbeitet unterschiedlich. Merkmale wie grobe und feine Maserungen, Farbschattierungen und Veränderungen sowie Verwachsungen haben Ihren Ursprung im Wuchs des Baumes. Sie sind bei Hölzern, die in der freien Natur wachsen, normal und deshalb nicht als Fehler, sondern vielmehr als Eigentümlichkeit des Naturwerkstoffes Holz anzusehen.

Das unbehandelte Holz (ausser Lagerhölzer) wird nach einiger Zeit vergrauen, kann verbläuen und verschimmeln. Um ihr Blockhaus zu schützen, sollten Sie es mit geeigneten Holzschutzmitteln behandeln.

Um Ihr Gartenhaus optimal zu schützen, empfehlen wir die Bodenbretter vorgängig mit einer farblosen Grundierung zu behandeln. Besonders die Unterseite, welche nach der Montage nicht mehr zu erreichen ist. Nur auf diese Weise wird das Eindringen der Feuchtigkeit verhindert.

Wir empfehlen unbedingt auch Türen und Fenster mit einer Grundierung zu behandeln. Es ist sehr wichtig sowohl die Innen- als auch die Aussenseiten der Türen und Fenster auf einmal zu streichen! Andernfalls können sie sich verziehen.

Nach dem Aufbau empfehlen wir Ihnen die Aussenhaut (ohne Dach) zu Grundieren, sobald diese trocken ist sollten Sie das Haus mit einer Holzlasur streichen, die das Holz vor Feuchtigkeit und UV-Strahlung schützt.

Beim Anstrich benutzen Sie hochwertiges Werkzeug und Farbe, beachten Sie die Sicherheits- und Verarbeitungshinweise des Farbenherstellers. Streichen Sie nie in praller Sonne oder beim regnerischen Wetter. Lassen Sie sich ausführlich bei Ihrem Fachhändler über den Holzschutz für unbehandelte Nadelhölzer beraten.

Durch einen regelmässigen Anstrich beeinflussen Sie im Wesentlichen die Lebensdauer Ihres Gartenhauses. Wir empfehlen Ihnen auch eine halbjährliche Inspektion des Gartenhauses.

2 Vorbereitung zur Aufbau

Werkzeuge und Vorbereitung der Details

Beim Aufbau brauchen Sie Folgendes:



Montagehelfer



Stehleiter



Hammer



Wasserwaage



Schraubenzieher



Säge



Messer



Bandmass



Zange



Bohrer

HINWEIS: Um Verletzungen durch eventuelle Holzsplitter zu vermeiden, tragen Sie bitte während der Montage entsprechende Schutzhandschuhe.



Wir wünschen Ihnen nun viel Spass und Erfolg beim Aufbau und jahrelange Freude mit Ihrem Gartenhaus!

1 Généralités



Cher client,

Nous sommes heureux que votre choix se soit porté sur notre maison de jardin!

Il est important de lire entièrement cette notice de montage avant de commencer la construction de votre maisonnette en poutres! Vous vous éviterez ainsi des problèmes et des pertes de temps inutiles.

Conseils:

- Avant son montage définitif, entreposez le kit de construction au sec et pas directement sur la terre, en le protégeant contre les intempéries (humidité, rayonnement du soleil, etc.). Ne pas conserver la marchandise dans un local chauffé!
- Au moment de choisir l'endroit de montage, veillez à ce que la maisonnette en poutres ne soit pas exposée à des conditions atmosphériques extrêmes (zones exposées à des vents forts). Le cas échéant, il serait bon d'ancrer la maisonnette en poutres dans des fondations.



Garantie

Votre maisonnette est réalisée en bois d'épicéa nordique de haute qualité et elle vous est livrée non traitée. Si elle devait donner lieu à des réclamations, malgré les soins apportés à notre contrôle en usine, nous vous demandons de remettre à votre revendeur spécialisé le bon de contrôle rempli et votre facture d'achat!

IMPORTANT: Veuillez impérativement conserver la documentation! Vous trouverez sur le bon de contrôle le numéro de contrôle de la maisonnette. La réclamation ne peut être traitée dans le cadre de la garantie que si vous communiquez le numéro de contrôle à votre revendeur spécialisé!

Ecarts qui ne constituent pas un motif de réclamation:

- Le bois est un produit naturel, ce qui fait que les réclamations reposant sur des phénomènes naturels ne tombent pas sous le coup de la garantie.
- Les réclamations concernant les matériaux ne sont pas acceptées si une peinture a déjà été appliquée!
- Nœuds qui sont inhérents au bois.
- Décolorations du bois qui n'exercent pas d'influences sur la durée de vie.
- Fissures / fentes de retrait qui ne sont pas traversantes et qui n'exercent pas d'influences sur la construction.
- Déformations du bois, sous réserve qu'il puisse encore être mis en œuvre.
- Sur les faces non visibles des planches du toit et du plancher, il se peut que les planches ne soient pas rabotées, on peut observer des différences de couleur et des flaches.
- Une réclamation tardive résultant d'un montage incorrectement réalisé, d'un affaissement de la maisonnette par suite de fondations et de soubassements incorrectement réalisés, est exclue.
- Une réclamation suite à des modifications apportées de son propre chef à la maisonnette, comme par exemple une déformation des madriers et des fenêtres/portes par suite d'une peinture du bois ou d'une construction insuffisantes, la fixation trop rigide du contreventement, le vissage des dormants sur les madriers, etc., est exclue.

Les recours en garantie se limitent au remplacement du matériel défectueux. Tous les autres recours sont exclus!



Peinture et entretien

Le bois est un produit naturel qui travaille de façon variable. Des caractéristiques telles que les madrures grossières et fines, les nuances de couleurs et les modifications, de même que les imbrications, ont leur origine dans la croissance du bois. Dans le cas de bois qui poussent en pleine nature, ces caractéristiques sont normales et ne doivent par conséquent pas être considérées comme des défauts mais, au contraire, comme une particularité de ce matériau naturel qu'est le bois.

Au bout de quelque temps, le bois non traité (à l'exception des longrines) prendra une teinte grise, il pourra bleuir et moisir. Pour protéger votre maisonnette en poutres, il convient que vous le traitiez avec des produits de protection du bois appropriés.

Pour protéger votre maison de jardin de façon optimale, nous vous conseillons de traiter préalablement les planches du plancher à l'aide d'un apprêt incolore. En particulier la face inférieure à laquelle vous ne pourrez plus avoir accès après le montage. Ce n'est que de cette façon que l'on empêche l'humidité de pénétrer.

Nous conseillons de traiter impérativement les portes et les fenêtres également à l'aide d'un apprêt. Il est très important de peindre en une seule fois aussi bien les faces intérieures que les faces extérieures des portes et des fenêtres! Dans le cas contraire, elles pourront se déformer.

Une fois le montage effectué, nous vous conseillons de revêtir l'extérieur (sans le toit) d'un apprêt. Dès que cet apprêt sera sec, vous devrez revêtir votre maison d'un glacis pour bois qui protégera le bois contre l'humidité et le rayonnement ultraviolet.

Pour la peinture, n'utilisez qu'un outillage et une peinture de haute qualité, et respectez les consignes de sécurité et de mise en œuvre du fabricant de peintures. Ne peignez jamais en plein soleil ou lorsque le temps est à la pluie. Faites-vous conseiller de façon détaillée par votre revendeur spécialisé quant à la protection à utiliser pour les conifères non traités.

En refaisant régulièrement la peinture, vous augmentez sensiblement la durée de vie de votre maison de jardin. Nous vous conseillons également une inspection semestrielle de votre maison de jardin.

2 Préparation au montage

Outils et préparation des détails

Pour le montage, vous avez besoin du matériel suivant:



une personne pour vous aider au montage



échelle double



marteau



niveau à bulle d'air



tournevis



scie



couteau



mètre-ruban



pince



foret

REMARQUE: Pour éviter les blessures provoquées par d'éventuels éclats de bois, nous vous demandons de porter des gants de protection correspondants lors du montage.



Nous vous souhaitons beaucoup de moments heureux, une installation réussie et beaucoup d'années joyeuses dans votre maisonnette!

1 Información general



Estimado cliente,

¡Nos alegra que haya elegido una casita nuestra!

¡Por favor, lea atentamente estas instrucciones de montaje antes de empezar a montarlo! Esto le ahorrará problemas y pérdida de tiempo.

Consejos:

- Preserve los elementos empaquetados hasta su ensamblaje completo en condiciones secas evitando el contacto directo con el suelo, y protéjalos contra las condiciones meteorológicas adversas (humedad, luz solar, etc.) ¡No las mantenga en una habitación con altas temperaturas!
- Durante la elección de la ubicación de la cabaña en su jardín, no escoja un lugar donde quede expuesta a condiciones climáticas extremas (zonas de fuertes nevadas o vientos fuertes), en caso contrario será necesario sujetar su cabaña (por ejemplo, con anclajes) al subsuelo.



Garantía

Su casita esta hecha de madera de abeto de alta calidad y se entregará en estado natural (rugoso). Si, a pesar de nuestras inspecciones minuciosas, se encontrara con defectos, presente al vendedor un listado completo de **verificación** y el recibo al vendedor.

ATENCIÓN: ¡Por favor, conservar la documentación relativa a la cabaña! El número de control de la casita se encuentra en el listado de verificación. ¡Sus quejas serán atendidas solamente si usted suministra al vendedor el número de control de su casita de madera!

La garantía no cubre:

- Características peculiares de la madera derivadas de la misma como un material natural
- Elementos que ya han sido pintados (madera tratada con conservantes de la madera)
- Elementos que contienen nudos que no afectan la estabilidad de una casita
- Diferentes tonos de color debido a las variedades estructurales de la madera que no afectan la esperanza de vida de la madera
- Elementos con pequeñas grietas / divisiones (causadas por el secado) que no son penetrantes y no afectan a la construcción de la casita
- Elementos torcidos de madera si pueden ser instalados todavía
- Tableros de techo y suelo con superficie (oculta) rugosa, variaciones de color, y disminución
- Quejas provocadas por un montaje incompetente de la casita o asentamientos de la casita debidos a fallos de la construcción de los cimientos
- Quejas causadas por alteraciones no autorizadas hechas en la cabaña, tales como el doblado de los elementos de madera o de las ventanas / puertas como consecuencia del incompetente trato de la madera, de la excesivamente rígida fijación de las tablas de acceso o atornillado de los marcos de las puertas a los elementos de las paredes, etc.

La satisfacción de las reclamaciones cubiertas por la garantía, se limita al intercambio de los materiales desaparecidos / defectuosos. ¡Todas las demás exigencias están excluidas!



Pintura y mantenimiento de la cabaña

La madera es un material natural que crece y se contrae debido a las condiciones climáticas. Grietas más pequeñas o más grandes, diferencias y cambios en los matices de colores y sus alternancias estructurales no son fallos, sino los resultados del crecimiento y de la peculiaridad de la madera como un material natural.

Con el tiempo la madera rugosa (excluyendo las vigas de la cimentación) cambia de color a gris o puede adoptar un color azul y enmohecer. Con el fin de proteger los elementos de su cabaña, deben ser tratados de inmediato con un conservante de madera.

Le recomendamos que cubra los suelos, especialmente sus partes inferiores, adonde no se puede llegar después del montaje de la cabaña, primero con un conservante incoloro de madera. Sólo de esta manera las tablas pueden protegerse de la penetración de la humedad.

También recomendamos que cubra las puertas y ventanas con conservantes de madera. Es esencial hacer el tratamiento tanto por dentro como por fuera de las superficies de las puertas y ventanas. En caso contrario, se pueden desarrollar deformaciones.

Después del ensamblaje de la cabaña, recomendamos para su acabado el uso de pintura resistente al agua para que proteja la madera contra la humedad y la radiación UV.

Para el acabado de su cabaña utilice únicamente herramientas y pinturas de alta calidad. Además, siga los manuales de instrucciones para las pinturas y las advertencias de seguridad y las instrucciones de uso proporcionadas por el fabricante. No pintar durante una luz intensa del sol o bajo la lluvia. Consulte a un experto en relación a las pinturas para madera áspera de coníferas y siga las instrucciones del fabricante de la pintura.

La aplicación de pintura extiende considerablemente la vida útil de su cabaña. Recomendamos una cuidadosa inspección de la cabaña dos veces al año.

2 Preparativos para el montaje

Herramientas y la preparación de los elementos

Para montar la cabaña, necesita lo siguiente:



Auxiliar de trabajo



Escalera



Martillo



Instrumento de nivelación



Destornillador



Sierra



Cuchillo



Metro



Tenazas



Taladro

Consejo: Con el fin de defenderse de las astillas, durante el montaje se recomienda llevar guantes de protección.



¡Le deseamos éxito en el montaje de su casa y que la disfrute por muchos años!

1 In generale



Gentile Cliente,

siamo veramente lieti che Lei abbia scelto la nostra casetta di legno per il Suo giardino!

E' importante leggere accuratamente le istruzioni prima di iniziare con il montaggio della Sua casetta di legno! In tal modo eviterà qualsiasi problema e perdita di tempo.

Consigli:

- Conservare il kit in luogo asciutto e non direttamente sul pavimento, protetto da agenti atmosferici (acqua, sole ecc.) fino al montaggio definitivo. Non conservare il prodotto in ambienti riscaldati !
- Nella scelta del luogo di collocamento, fare attenzione che la casetta non sia esposta a condizioni atmosferiche estreme (vento forte); eventualmente ancorare la casetta ulteriormente con le fondamenta.



Garanzia

La vostra casetta è stata realizzata con pregiato legno di abete rosso nordico e viene consegnata in stato non trattato. Qualora, nonostante il nostro accurato controllo in fabbrica, dovessero sorgere reclami, sarà necessario presentare al negoziante il certificato di controllo compilato insieme alla fattura d'acquisto!

IMPORTANTE: E' assolutamente necessario conservare la documentazione! Sul certificato di controllo è riportato il numero di controllo della casa. Reclami possono essere evasi in garanzia unicamente se comunicherete il numero di controllo al vostro negoziante!

Divergenze che escludono motivo di reclamo:

- Il legno è un prodotto naturale e pertanto le contestazioni relative allo stato naturale non rientrano nella garanzia.
- Reclami relativi al materiale non vengono accettati una volta verniciato!
- Rami cresciuti nel legno.
- Scolorimenti del legno che non influiscono sulla durata.
- Crepe /fessure non passanti che non compromettono la costruzione.
- Nodi nel legno a condizioni che possa ancora essere lavorato.
- Nei punti invisibili del tavolame tetto e pavimento sono ammesse tavole non piallate; sono inoltre ammesse differenze di colore e spigoli dell'albero.
- Reclami successivi dovuti a montaggio non conforme, cedimento della casetta a causa di fondamenta errate sono esclusi.
- I reclami causati introducendo modifiche proprie alla casetta, p.es. deformazione di tavole e finestre/porte dovute ad un montaggio incompetente, fissaggio troppo rigido del listello antivento, avvitarmento dei telai delle porte con le tavole di legno ecc., sono esclusi.

Le rivendicazioni di garanzia sono limitate alla sostituzione del materiale difettoso. Ogni altra rivendicazione è esclusa!



Verniciatura e cura

Il legno è un prodotto naturale e si muove in modo diverso. Caratteristiche quali venature grosse e fini, sfumature di colore e cambiamenti nonché nodi sono dovuti alla crescita dell'albero. Sono del tutto normali nei legni che crescono all'aperto, e pertanto non sono da considerare difetti ma piuttosto una caratteristica del legno naturale.

Il legno non trattato (ad eccezione dei travetti) diventa grigio col tempo, può scolorirsi e fare la muffa. Per proteggere la vostra casetta di legno, è consigliabile trattarla con opportuni preservanti per legno.

Per proteggere al meglio la vostra casetta da giardino, consigliamo di trattare le tavole del pavimento preventivamente con un colore di fondo neutro, in particolare la parte inferiore che non sarà più raggiungibile dopo il montaggio. Solo in questo modo la penetrazione di umidità potrà essere evitata.

Consigliamo di trattare in ogni caso anche porte e finestre con un colore di fondo. E' molto importante verniciare sia il lato interno che quello esterno delle porte in un'unica soluzione, altrimenti potrebbero deformarsi !

Dopo il montaggio, consigliamo di applicare uno strato di fondo sulla pelle esterna (senza tetto), non appena il medesimo si sarà asciugato, verniciare la casetta con una velatura per legno per proteggere il legno dall'umidità e dalle radiazioni UV.

Per la verniciatura, usare attrezzi e vernici di qualità e rispettare le istruzioni di sicurezza e applicazione del produttore della vernice. Non verniciare in pieno sole o in caso di pioggia. Farsi consigliare dettagliatamente dal venditore sulla protezione di legni di conifera non trattati.

Con una regolare verniciatura aumenterete notevolmente la durata della vostra casetta da giardino. Consigliamo un'ispezione semestrale della casetta.

2 Preparazione al montaggio

Attrezzi e preparazione dei particolari

Attrezzi occorrenti:



aiutante



scala doppia



martello



livella a bolla d'aria



cacciavite



sega



coltello



metro



pinza



trapano

AVVERTENZA: Per evitare lesioni causate da eventuali schegge di legno, portare guanti di protezione durante il montaggio.



Vi auguriamo successo nel montaggio della casa e speriamo che la godrete per molti anni!

1 Generell informasjon



Kjære kunde,

det gleder oss at du valgte hagehuset vårt!

Les monteringsanvisningen grundig før du går i gang med å sette sammen huset! For å unngå problemer og bruk av unødig tid.

Husk:

- La huset være innpakket og oppbevar det på et tørt sted, ikke i direkte kontakt med bakken og godt beskyttet mot vær og vind (fuktighet, solskinn osv.), helt frem til arbeidet påbegynnes. Huspakken må ikke oppbevares i et oppvarmet rom!
- Kontrollerer leveransen mot delelisten for å se om alle delene er inkludert, før du starter monteringen. Sorter delene i samsvar med monteringsanvisningen og legg de fire sidene ut i forhold til monteringsrekkefølgen.
- Bygging må skje i henhold til lokale byggeforskrifter, som varierer ut i fra områdets grunnforhold og klima. Sjekk dette for din kommune.
- Hvilke bygg som er melde-/søknadspliktig varierer tilsvarende.
- Våre boder og anneks er komplette grunnsett.
- Brukeren må selv forsikre seg om at produktet er godt nok forankert til grunnen i forhold til lokale forhold.
- På utsatte steder bør det barduneres med waier til grunn, og ekstra tetting/ pakninger benyttes for å unngå vanninntregning ved ekstreme værforhold.
- Taket må måkes for snø om vinteren.
- Produktet må omgående behandles med korrekt grunning, maling/ beis utvendig og innvendig, se veiledning nedenfor.
- Ulike klimatiske forhold vil gi ulike behov.
- Frem til produktet er ferdig montert med takdekke og behandlet må det beskyttes mot fukt og vind.



Garanti

Dette huset er fremstilt av høykvalitets gran (furu brukes i enkelte tilfeller) og leveres ubehandlet. Dette huset har gjennomgått en grundig inspeksjon. Dersom du likevel skulle ha grunn til reklamasjon, ber vi deg fylle ut kontrollskjema og sende det sammen med kjøpsbeviset og kvitteringen til forhandleren.

OBS: Sørg for å oppbevare all dokumentasjon som følger med huspakken! Husets serienummer er oppført på kontrollskjema. Vi kan kun behandle en reklamasjon dersom du sender husets serienummer til forhandleren!

Garantien dekker ikke:

- Særegenhet i treverket som et naturlig materiale
- Deler som allerede er behandlet (malt, grunnet)
- Deler av huset som inneholder hele kvister som ikke representerer en fare for husets stabilitet

Monteringsanvisning - Norsk

- Variasjoner i fargetone som er forårsaket av forskjeller i trestrukturen og som ikke har betydning for treverkets levetid
- Deler av huset som sprekker på grunn av tørking, dvs. små sprekker/ riss som ikke er gjennomgående og som ikke påvirker husets struktur
- Deler av vridd tre som likevel kan monteres
- Tak- eller gulvplank som på skjulte overflater kan oppvise uhøvlede områder, fargeforskjeller og vankant
- Reklamasjoner fordi huset er blitt montert på ukyndig måte eller fordi huset sigrer på grunn av ukyndig utført fundament
- Reklamasjoner fordi det er blitt gjort endringer på huset på eget initiativ, som f.eks. formendringer på deler av tre eller dører/ vinduer. På grunn av ukyndig behandling av treverket; at stormavstivere er festet for stramt, dørkarmen er blitt skrudd inn i veggbord eller lignende.

Reklamasjonene som dekkes av garantien er begrenset til å omfatte erstatning av manglende/ feil materiale. Alle andre krav er utelukket!

Produsent forbeholder seg retten til å endre tekniske egenskaper ved produktet.



Maling og vedlikehold av hagehuset

Tre er et naturlig materiale som beveger og tilpasser seg i forhold til værforholdene. Større eller mindre sprekker, fargeforskjeller og endringer samt ulikheter i treets struktur er ikke feil, men et resultat av treets vekst og en særegenhet i treverket som et naturlig materiale.

Ubehandlet treverk blir grått hvis det blir værende ubehandlet over tid og kan bli blått og begynne å råtne. For å beskytte treverket i hagehuset, må det før montering behandles med grunning.

Alle deler må behandles med grunning (f. eks. Visir) på alle sider (innvendig og utvendig), laftespor, not og fjær, før montering. Husk: Endeved 3-4 strøk vått i vått. Grunn vinduer og dører på alle sider. Grunn tak/gulvbord på alle sider.

Hvorfor grunning?

Det er ekstra mye endeved i en laftehytte. Hvert eneste laftespor har endeved. Det er endeveden som tar til seg mest fuktighet i treverk. Ved produksjon av en laftehytte blir treverket tørket før det blir produsert. Dette gjør at delene lettere tar til seg fuktighet når pakken blir åpnet. Tørket trevirke som blir utsatt for fuktighetssvingninger vil ofte vri seg og skape spenninger i treverket som kan utløse mange problemer. En grunning sin viktigste funksjon er å redusere fuktopptak og dermed redusere spenningsproblemer. Den andre viktige funksjonen til en grunning er å hindre dannelse av sopp og råte. Dette oppstår gjerne på steder som har dårlig lufting, som f. eks. i laftesporene. Når huset er ferdig montert, må det ferdige huset behandles med et værbestandig malingsstrøk utvendig som beskytter treverket mot fuktighet og UV-stråler. Innvendig må huset etterbehandles i henhold til bruksmønster.

Bruk maleredskaper og maling/ beis av høy kvalitet når du maler huset. Følg anvisningene på spannet og produsentens sikkerhets- og bruksanvisninger. Du må aldri male en overflate i sterkt sollys eller i regnvær. Forhør deg hos en malerspesialist når det gjelder hvilken maling som egner seg for ubehandlet myktré, og følg anvisningene fra produsenten.

Dersom huset er blitt malt på riktig måte, vil husets levetid forlenges betraktelig. Vi anbefaler at du inspiserer huset grundig hvert halvår.

2 Foreberedelse før montering

Verktøy og forberedelse før montering

Du trenger følgende verktøy ved montering:



monteringshjelp



stige



hammer



drill

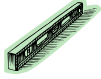

vater



skrutrekker



sag



kniv



målebånd



avbiter tang

OBS: For å unngå flis anbefaler vi bruk av hansker under monteringen.



Vi ønsker deg lykke til med det nye hagehuset og håper du får glede av det i mange år!

1 Allmän information



Bäste kund,

Vi är glada för att du valt att skaffa ett trädgårdshus från oss!

Vänligen läs monteringsanvisningarna noggrant innan du påbörjar monteringen av huset! Du undviker därigenom problem och spiller ingen tid.

Rekommendationer:

- Förvara husets förpackning, tills det är färdigmonterat, på en torr plats, men inte i direkt kontakt med marken, skyddad från väder och vind (fukt, solljus, etc.). Förvara inte husets förpackning i ett uppvärmt utrymme!
- När du väljer plats för trädgårdshuset, försäkra dig om att huset inte utsätts för extrema väderförhållanden (områden med kraftigt snöfall eller vindar); i så fall bör du förankra huset (till exempel med jordankare) i marken.



Garanti

Ditt hus är tillverkat av gran av hög kvalitet och levereras i naturlig (obehandlad) form. Om du, trots vår noggranna besiktning, skulle ha några reklamationer, vänligen skicka den ifyllda kontrollblanketten och inköpsbeviset till vår återförsäljare.

SE UPP! Vänligen se till att behålla dokumentationen tillsammans med husets förpackning! Kontrollblanketten innehåller husets kontrollnummer. Vi kan enbart granska reklamationer om du skickar med husets kontrollnummer till återförsäljaren!

Garantin omfattar inte:

- Egenheter för trä som ett naturmaterial.
- Redan målade trädetaljer (behandlade med träskyddsmedel)
- Trädetaljer som innehåller hela kvistar som inte äventyrar husets stabilitet
- Variationer i färgton orsakade av olikheter i träets struktur som inte påverkar träets livslängd
- Trädetaljer som innehåller mindre sprickor/spalter (orsakade av torkning) som inte är genomgående och inte påverkar husets konstruktion
- Skeva trädetaljer som ändå går att montera
- Tak och golvbrädor som på sina dolda ytor kan ha vissa ohyvlade områden, färgskiftningar och -mattning
- Reklamationer på grund av oskicklig montering av huset eller sättningssskador på grund av en felaktigt uppförd grund
- Reklamationer orsakade av egna ändringar av huset, så som deformation av trädetaljer och dörrar/fönster på grund av ett oskickligt tillvägagångssätt vid montering av trädetaljer; fastsättning av stormbeslag för styvt, dörrkarmar som skruvas i väggreglar, mm.

Reklamationer som omfattas av garantin tillgodoses i den omfattningen att det bristfälliga/felaktiga materialet ersätts. Alla andra anspråk lämnas utan åtgärd!



Målning och underhåll av trädgårdshus

Trä är ett naturmaterial som växer och anpassar sig efter väderförhållanden. Större och mindre sprickor, förändringar och skiftningar i färgton, samt även förändringar i träets struktur är inte felaktigheter, utan ett resultat av träets tillväxt och egenheter för trä som ett naturmaterial.

Obehandlat trä (undantaget grundsyllar) blir gråaktiga efter att ha lämnats orörda ett tag, de kan bli blå och börja mögla. För att skydda trädetaljer på ditt trädgårdshus måste du omedelbart behandla dem med träskyddsmedel.

Vi rekommenderar att du i förväg täcker golvbrädorna med ett färglöst träimpregneringsmedel, i synnerhet brädornas undersidor vilka du senare inte kommer åt när huset väl är monterat. Endast detta förebygger fuktinträning.

Vi rekommenderar definitivt att du även behandlar dörrar och fönster med ett bra impregneringsmedel och gör det både på in- och utsidan! Annars kan dörrar och fönster bli skeva.

Efter att huset är färdigmonterat, rekommenderar vi att slutbehandla det med en väderbeständig färg som skyddar träet från fukt och UV-strålning.

Använd redskap och färg av bra kvalitet vid målningen, följ användaranvisningen för färgen samt tillverkarens säkerhets- och användarinstruktioner. Måla aldrig en yta i starkt solljus eller vid regnväder. Rådgör med en specialist om färger som lämpar sig för obehandlat barrträ och följ färgtillverkarens anvisningar.

Husets livslängd förlängs avsevärt om det målas på rätt sätt. Vi rekommenderar att du besiktigar huset noggrant var sjätte månad.

2 Monteringsförberedelser

Verktyg och förberedelse av komponenter

För att montera trädgårdshuset behöver du följande verktyg:



monteringshjälp



stege



hammare



vattenpass



skruvmejsel



såg



kniv



måttband



tång



borr

RÅD: För att undvika att få stickor, rekommenderar vi att du använder arbetshandskar under monteringen.



Vi önskar dig lycka till med monteringen av trädgårdshuset och mycket glädje med detta hus i många år framöver!

1 Yleistä tietoa



Hyvä asiakas,

Olemme iloisia, että valintasi kohdistui tuotteeseemme!

Ole hyvä ja lue kokoamisohje huolellisesti ennen pystytyksen aloittamista! Tämä auttaa välttämään ongelmia ja säästää aikaa.

Suosituksia:

- Säilytä pystytystä odottava mökkipaketti kuivassa paikassa, joka ei ole suorassa kosketuksessa maan kanssa, ja säältä suojassa (kosteus, aurinko jne.). Älä pidä pakettia lämmitetyssä tilassa!
- Valitessasi mökille paikkaa varmista, ettei se tule joutumaan alttiiksi äärimmäisille sääoloille (voimakkaalle lumentulolle tai koville tuulille); muuten se tulee kiinnittää (esim. ankkureilla) maaperään.



Takuu

Mökkisi on valmistettu korkealuokkaisesta kuusesta ja toimitetaan luonnollisessa (käsittelemättömässä) muodossa. Mikäli perusteellisesta tarkastuksestamme huolimatta sinulla on tuotteesta huomautettavaa, ole hyvä ja toimita täytetty valvontailmoitus ja ostolasku tuotteen myyjälle.

HUOM! Muista säilyttää mökkipaketin mukana tulevat asiakirjat! Valvontailmoituksessa on tuotteen valvontanumero. Mahdollisten valitusten käsittely edellyttää, että mökin valvontanumero ilmoitetaan myyjälle!

Takuu ei kata seuraavia:

- Puun erikoispiirteet luonnonmateriaalina
- Puuosat, jotka on jo maalattu (käsitelty kyllästysaineella)
- Puuosien oksakohdat silloin, kun ne eivät vaaranna mökin vakautta
- Puun rakenteesta johtuvat sävyerot, jotka eivät vaikuta puun kestävyteen
- Puuosissa olevat (kuivumisen aiheuttamat) pienet halkeamat/raot, jotka eivät mene puun läpi, eivätkä vaikuta talon rakenteeseen
- Taipuneet puuosat, jotka voidaan kaikesta huolimatta asentaa
- Katto- ja lattialaudat, joiden piiloon jäävällä puolella saattaa olla höyläämättömiä kohtia, värieroja tai vajaasärmä
- Valitukset, jotka johtuvat mökin virheellisestä pystytyksestä tai puutteellisen perustuksen aiheuttamasta vajoamisesta
- Valitukset, jotka johtuvat mökkiin oma-aloitteisesti tehdyistä muutoksista, kuten taitamattomasta käsittelystä johtuva puuosien ja ovien/ikkunoiden vääntyminen; jäykisteiden liian tiukka asentaminen, ovenkarmien ruuvaaminen seinäpuihin yms.

Takuun piiriin kuuluvat huomautukset hoidetaan vaihtamalla viallinen/väärä materiaali uuteen. Muita mahdollisia vaatimuksia ei huomioida!



Mökin maalaaminen ja huolto

Puu on luonnonmateriaali, joka laajenee ja elää sääolojen mukaan. Pienet ja suuret raot, värisävyerot ja -muutokset sekä puun rakenteen vaihtelu eivät ole virheitä, vaan ne johtuvat puun laajenemisesta ja luonnonmateriaalin ominaisuuksista.

Käsittelemätön puu (lattiapalkkeja lukuun ottamatta) muuttuu ajan myötä harmahtavaksi, ja saattaa sinertyä ja homehtua. Tämän vuoksi mökin puuosat tulee välittömästi suojata kyllästysaineella.

Lattialaudat kannattaa käsitellä etukäteen värittömällä puunkyllästysaineella, etenkin lautojen alapinnat, joihin ei pääse käsiksi enää mökin pystytyksen jälkeen. Se on ainoa keino estää kosteutta imeytymästä puuhun.

Myös ovet ja ikkunat tulee käsitellä kyllästysaineella niin sisä- kuin ulkopuolelta! Muuten on vaara, että ovet ja ikkunat vääntyvät.

Mökin pystytyksen jälkeen se kannattaa käsitellä kauttaaltaan sään vaikutuksilta suojaavalla maalilla, joka suojaa puuta kosteudelta ja UV-säteilyltä.

Maalattaessa käytä laadukkaita työvälineitä ja maaleja, noudata maalausohjetta sekä valmistajan turvallisuus- ja käyttöohjeita. Älä koskaan maalaa suorassa auringonpaisteessa tai sateella. Kysy asiantuntijalta käsittelemättömälle havupuulle sopivista maaleista ja noudata maalinvalmistajan ohjeita.

Asianmukainen maalaus pidentää rakennuksen käyttöikää huomattavasti. Suosittelemme, että tarkastat mökin huolellisesti joka kuuden kuukauden välein.

2 Pystytyksen valmistelu

Työkalut ja osien valmistelu

Mökin pystyttämisessä tarvitaan seuraavia työkaluja:



apulainen



tikkaat



vasara



vatupassi



ruuvimeisseli



saha



veitsi



rullamitta



pihdit



pora

NEUVO: Tikkujen välttämiseksi käytä asianmukaisia suojakäsineitä kokoamisen aikana.



Toivotamme täydellistä menestystä puutarhamajan asennuksessa ja paljon iloa majasta monina tulevina vuosina!

1 Generelt



Kære kunde,

Tak fordi du valgte vores havehus!

Venligst læs hele monteringsvejledning igennem før du går i gang for at undgå unødvendig tidsspilde og problemer!

Tips:

- Opbevar pakken med havehuset tørt, beskyttet mod vejr og vind og ikke direkte på jordoverfladen indtil monteringen er afsluttet. Pakken må ej heller være i nærheden af en varmekilde.
- Ved placeringen af havehuset vær opmærksom på, at huset ikke kommer til at stå i ekstreme vejrforhold (stærk vind, meget sne i.lign.), i så fald skal huset fæstnes med passende ankere til grunden.



Garanti

Havehuset er fremstillet af højkvalitativ gran tømmer og leveres i ubehandlet stand. Hvis der på trods af vores grundig kvalitetskontrol skulle være klager eller mangler ved huset, skal disse indgives til sælgeren sammen med udfyldt kontrolskema og indkøbskvittering.

OBS: Venligst opbevar vedlagte dokumentation til havehuset! Husets kontrolnummer fremgår af kontrolskemaet. Klager kan kun indgives hvis I oplyser kontrolnummeret til sælgeren.

Garantien omfatter ikke følgende:

- Ujævnheder og afvigelser grundet træets naturlige egenskaber
- Detaljer som allerede er behandlede med træbeskyttelse
- Detaljer som indeholder hele knaster der ikke påvirker husets stabilitet
- Afvigelser i træets farvenuancer som ikke påvirker træets levetid
- Detaljer som indeholder små sprækker opstået ved tørning der ikke er gennemgående og som ikke påvirker husets konstruktion
- Trædetaljer med skævhed, der stadig kan monteres
- Tag- og gulvbrædder, der indeholder uhøvlede pletter, farveafvigelser eller andre pletter i ikke synlige steder
- Klager der opstået pga. ukyndig montering af huset eller ved placeringen af huset på et ukorrekt udført fundament
- Klager, der er opstået pga. egne tiltag eller ændringer ved huset, såsom skævhed af trædetaljer, døre og vinduer pga ukyndig behandling af træet; stormlisternes for stram montering; dørkarme fastmonteret i vægdetaljer o.lign.

Garantien udøves ved at ombytte den fejlbehæftede element med en ny. Alle andre krav tilgodeses ikke!



Havehusets maling og vedligeholdelse

Træ er et naturmateriale, der bevæger sig afhængigt af vejrforhold. Små og store sprækker, farveafvigelse og ændringer, samt ændret træstruktur er ikke fejl, men træets egenskaber som naturmateriale.

Ubehandlet træ (undtagen fundamentsprosser) ændres efterhånden til gråligt, kan endda blive blåligt og muggent. For at beskytte dit havehus og dens trædele bedst, skal du så hurtigt som muligt behandle træet med træbeskyttelse.

Vi anbefaler først at behandle gulvbrædder med et ufarvet træbeskyttelse, specielt bræddernes underside, som ikke vil være tilgængeligt for yderligere behandling efter monteringen. Kun på den måde kan man forhindre fungten at trænge ind.

Vi anbefaler, at du behandler også døre og vinduer med træbeskyttelse. Det er vigtigt at behandle døre og vinduer både på inder- og ydersiden! Ellers kan de trække sig skæve efterhånden.

Efter monteringen af huset anbefaler vi brugen af en passende maling for at beskytte ydersiden mod vejr, vind og UV-stråling.

Brug højkvalitative redskaber og maling under malingsarbejdet, følg instruktioner og anbefalinger fra malingsproducenten. Mal aldrig i direkte sollys eller i regnvejr. Søg tips og råd hos din malingsforhandler og følg deres instruktioner.

Regelmæssig maling af havehuset forlænger betydeligt dets levetid. Vi anbefaler en grundig gennemgang af huset ved hvert halve år.

2 Forberedelse for montage

Redskaber og forberedelse af alle elementer

For monteringen har du brug for følgende redskaber og værktøj:



en hjælper



stige



hammer



vatterpass



skruetrækker



sav



kniv



målebånd



tang



boremaskine

TIPS: For at undgå splinter anbefaler vi brug af arbejdshandsker.



**Pøj-pøj med monteringen af Dit nye havehus!
Vi håber, I får glæde af det mange år frem i tiden!**

1 Algemene informatie



Geachte klant,

Wij zijn zeer verheugd dat U beslist heeft in het voordeel van ons tuinhuis!

Lees deze handleiding aandachtig alvorens te starten met de montage van het tuinhuis! U zal zo problemen voorkomen en geen tijd verliezen.

Aanbevelingen:

- Bewaar het bouwpakket op een droge plaats tot het volledig gebouwd is, maar niet in direct contact met de grond en beschermd tegen weersomstandigheden (vochtigheid, zonlicht, enz.). Bewaar het pakket niet in een verwarmde ruimte!
- Wanneer U de locatie kiest voor het tuinhuis, let er dan op dat het enerzijds niet onderhevig is aan extreme weersomstandigheden (plaatsen met zware sneeuwval of winden); anderzijds bevestigt U het huis best (bv. met ankers) aan de ondergrond.



Garantie

Uw huis is gemaakt van hoogwaardige vuren hout en geleverd in natuurlijke (onbehandelde) vorm. Als, ondanks onze gedegen inspectie, U toch klachten zou hebben, stuur dan het ingevulde controleblad en de aankoopfactuur naar de verkoper..

OPGELET: Gelieve de bij Uw bouwpakket gevoegde documentatie te bewaren! Het controleblad bevat het controlenummer van Uw tuinhuis. We kunnen enkel klachten behandelen indien U het controlenummer aan Uw verkoper bezorgt!

De garantie dekt niet:

- Eigenaardigheden van hout als natuurlijk materiaal
- Houten reeds geschilderde delen (behandeld met een houtbeschermingsmiddel)
- Knoesten in het hout die de stabiliteit van het tuinhuis niet in het gedrang brengen
- Kleurschakeringen veroorzaakt door verschillen in houtstructuur die de levensduur van het hout niet beïnvloeden.
- Houten afwerkingsstukken (veroorzaakt door het drogen) kleine scheuren en openingen die geen invloed hebben op de structuur van het tuinhuis
- Verwongen houten afwerkingsstukken, als ze desondanks toch kunnen geïnstalleerd worden.
- Dak- en vloerpanelen die op verborgen plaatsen ongeschaafde plekken, kleurverschillen en tanning kunnen vertonen.
- Klachten voortkomend uit een incompetente wijze van installeren van het tuinhuis of het naastgelegen huis tengevolge van een incompetente fundering.
- Klachten veroorzaakt door het aanbrengen van zelf-geïnitieerde wijzigingen, zoals het vervormen van houten details aan deuren/ramen tengevolge van incompetente behandeling van het hout; aan het tuinhuis, het te vast bevestigen van stormankers, deurlijsten die worden vastgeschroefd aan wand logs, etc.

De klachten gedekt door garantie zijn beperkt tot het vervangen van gebrekkig/foutief materiaal. Alle andere vragen worden uitgesloten!



Tuinhuis, schilderen en onderhoud

Hout is een natuurlijk materiaal, zet uit en past zich aan aan de weersomstandigheden. Grote en kleine scheuren, kleurverschillen en – veranderingen, net als een veranderende houtstructuur zijn geen fouten, maar een resultaat van het uitzetten van het hout en van de aard van het hout als natuurlijk materiaal.

Onbehandeld hout (behalve de funderingsbalken) kan grijs worden als het een tijd met rust wordt gelaten, het kan blauw en schimmelig worden. Om de houten details van Uw tuinhuis te beschermen, moet U ze onmiddellijk behandelen met een houtbeschermingsmiddel.

We raden aan dat U de vloerdelen met een kleurloze middel impregneert, vooral de onderkanten, die U niet meer kan bereiken eens het tuinhuis is geassembleerd. Alleen zo voorkomt U het doordringen van vocht.

We raden absoluut aan om ook de deuren en ramen kleurloos te impregneren, zowel aan de binnen- als aan de buitenkant! Anders kunnen ze verwrongen geraken.

Nadat het tuinhuis volledig is geassembleerd, bevelen we als finale afwerking het aanbrengen van een dekkende verf aan die het hout zal beschermen tegen vocht en UV-straling.

Gebruik bij het schilderen kwaliteitsgereedschap en –verven, Volg de bij de verf geleverde veiligheids-gebruikshandleiding. Schilder nooit een oppervlak in felle zon of bij regenweer. Consulteer een specialist betreffende verven die geschikt zijn voor onbewerkt hout en volg de instructies van de verffabrikant.

Het degelijk schilderen van Uw tuinhuis zal de levensduur ervan aanzienlijk verlengen. We raden U aan het tuinhuis elke zes maanden grondig te inspecteren.

2 Voorbereiding voor montage

Gereedschappen en voorbereiding van de onderdelen

Om het tuinhuis te monteren, zal U volgende gereedschappen nodig hebben:



montagesteun



ladder



hamer



waterpas



schroevendraaier



zaag



mes



rolmeter



knijptang



boormachine

Raadgeving: Om splinters te vermijden, raden we U aan de overeenkomstige beschermende handschoenen te dragen tijdens het montageproces.



We wensen U alle success met Uw tuinhuismontage en heel veel plezier ermee in de komende jaren!

1 Informações gerais



Estimado cliente,

É com prazer que constatamos que se decidiu pela nossa casa de jardim!

Leia cuidadosamente o manual de montagem antes de iniciar a instalação da casa! Evita assim problemas e perda de tempo.

Recomendações:

- Conserve a embalagem da casa até estar completamente montada num local seco, mas não em contacto direto com o solo, protegida das condições meteorológicas (humidade, sol, etc.) Não mantenha a embalagem da casa numa divisão aquecida!
- Quando seleccionar a localização da casa de jardim, assegure-se que a casa não estará sujeita a condições meteorológicas extremas (áreas com queda de neve ou ventos intensos); caso contrário deve prender a casa (por exemplo com estacas) ao subsolo.



Garantia

A sua casa é feita de abeto de alta qualidade e é fornecida em forma natural (não processada). Se, apesar da nossa rigorosa inspeção, tiver queixas, é favor apresentar a ficha de controlo devidamente preenchida e a fatura da venda ao vendedor do produto.

ATENÇÃO: Assegure-se que conserva a documentação que acompanha a embalagem da casa! A ficha de controlo inclui o número de controlo da casa. Só poderemos analisar queixas se apresentar o número de controlo da casa ao vendedor!

A garantia não cobre:

- Peculiaridades da madeira como material natural
- Detalhes de madeira já pintados (processados com um conservante de madeira)
- Detalhes em madeira contendo ramos inteiros que não comprometem a estabilidade da casa
- Variações de tom de cor causadas por diferenças na estrutura da madeira que não influenciam a vida útil da madeira
- Detalhes de madeira contendo (causadas pela secagem) pequenas fendas/lacunas que não passam e não influenciam a estrutura da casa
- Detalhes de madeira retorcida caso possa ser instalada
- Placas de teto e piso que possam ter em suas superfícies ocultas algumas áreas não aplainadas, diferenças de cores e palidez
- Queixas resultantes de uma instalação incompetente da casa ou derivadas do desabamento da casa devido a fundações feitas de forma incompetente.
- Queixas causadas pela introdução de alterações à casa por auto-iniciativa, tais como a deformação de detalhes de madeira e portas/janelas devido a uma forma incompetente de processamento da madeira; fixação das cintas de tempestade demasiado rígida, molduras de portas aparafusadas aos troncos da parede, etc.

As queixas cobertas pela garantia são satisfeitas com a substituição do material eficiente/defeituoso. Todas as outras solicitações serão excluídas!



Pintura da casa de jardim e manutenção

A madeira é um material natural, que cresce e se adapta consoante as condições meteorológicas. Fendas grandes e pequenas, diferenças de tonalidade da cor e alterações, bem como uma estrutura variável da madeira, não são erros, mas sim o resultado da madeira a crescer e uma peculiaridade da madeira enquanto material natural.

A madeira não processada (exceto vigas das fundações) fica acinzentada depois de ter sido deixada sem ser tocada durante algum tempo, e pode ficar azul e desenvolver bolor. Para proteger os detalhes de madeira da sua casa de jardim, tem de os tratar imediatamente com um conservante para madeira.

Recomendamos que cubra antecipadamente as tábuas do chão com um agente impregnante para madeira incolor, em especial as laterais das tábuas às quais vai deixar de ter acesso assim que a casa estiver montada. Só assim poderá prevenir a penetração de humidade.

Recomendamos certamente que trate também as portas e janelas com um agente impregnante para madeira, tanto do interior como do exterior! Caso contrário as portas e janelas podem empenar.

Uma vez concluída a montagem da casa, recomendamos um acabamento definitivo com uma tinta de proteção contra intempéries que proteja a madeira contra a humidade e a radiação UV.

Durante a pintura, utilize ferramentas e tintas de boa qualidade, siga o manual de aplicação da tinta e as instruções de segurança e utilização do fabricante. Nunca pinte uma superfície sob luz do sol intensa ou em tempo chuvoso. Consulte um especialista em tintas adequada para madeira de coníferas não processada e siga as instruções do fabricante da tinta.

Uma vez devidamente pintada, a vida útil da sua casa de jardim aumenta substancialmente. Recomendamos que inspecione a casa cuidadosamente a cada seis meses.

2 Preparação para a montagem

Ferramentas e componentes da preparação

Para montar a casa de jardim, vai precisar das seguintes ferramentas:



auxiliar de montagem



escada



martelo



nível de bolha



chave de parafusos



serra



faca



fita métrica



alicate



berbequim

CONSELHO: Para evitar lascas, recomendamos que use luvas de proteção correspondentes durante o processo de montagem.



Desejamos-lhe total sucesso com a instalação da casa de jardim e muita alegria com esta casa por muitos anos!

1 Všeobecné informace



Vážený zákazníku,

Jsme rádi, že jste se rozhodl pro náš zahradní domek!

Před započítím instalace domku se důkladně seznamte s montážním návodem! Vyhnete se tak problémům a zabráníte časovým ztrátám.

Doporučení:

- Stavebnici domku skladujte až do kompletního dokončení na suchém místě, ale nikoliv přímo na zemi, a tak, aby byla stavebnice chráněna před vlivem počasí (vlhkost, slunce, atd.). Stavebnici domku neskladujte ve vytápěné místnosti!
- Při výběru stanoviště pro zahradní domek dbejte na to, aby domek nebyl vystaven vlivům extrémního počasí (oblasti se silným sněžením nebo větrem); v opačném případě byste měl domek osadit na základovou desku (např. pomocí kotev).



Záruka

Váš domek je vyroben z vysoce kvalitního smrku (severský smrk) a dodán v přírodní podobě. Pokud i přes naši důkladnou kontrolu dojde k reklamaci, prosím předložte vašemu prodejci vyplněný kontrolní list a nákupní fakturu k výrobku.

Pozor: Uchovejte prosím průvodní dokumentaci dodávanou s domkem! Kontrolní list obsahuje kontrolní číslo domku. Reklamaci můžeme přijmout jen tehdy, pokud předložíte prodejci kontrolní číslo domku!

Záruka se nevztahuje na:

- Zvláštnosti dřeva jako přírodního materiálu
- Dřevěné detaily již opatřené povrchovou úpravou (ošetřeno ochranným prostředkem na dřevo, impregnace)
- Dřevěné detaily (komponenty), které neohroží stabilitu domku
- Změny barevných odstínů způsobené rozdíly struktury dřeva, které nemají vliv na životnost dřeva
- Dřevěné detaily obsahující drobné praskliny / mezery (způsobené vysycháním), které nejsou průchozí a nemají vliv na konstrukci domku
- Dřevěné detaily, pokud však mohou být instalovány
- Střešní a podlahové desky, které mohou mít na zakrytém povrchu dílčí neohoblované plochy, barevné rozdíly a smrštění
- Reklamacie vyplývající z neodborného způsobu instalace domku či případy, kdy si domek sedá v důsledku neodborného provedení základů
- Reklamacie způsobené neoprávněnými změnami na domku, jako je následná deformace dřevěných detailů a dveří / okna kvůli neodbornému způsobu zpracování dřeva, příliš těsné upevnění zavětrování, přišroubování zárubní na stěnové trámy, atd.

Oprávněně uplatněná reklamacie je vyřešena nahrazením nedodaného/ vadného materiálu. Veškeré ostatní nároky jsou vyloučeny!



Zahradní domek – povrchové úpravy a údržba

Dřevo je přírodní materiál, roste a přizpůsobuje se v závislosti na povětrnostních podmínkách. Velké i malé praskliny, rozdíly a změny barevného odstínu, stejně jako měnící se struktura dřeva nejsou vady, ale výsledky růstu dřeva a zvláštností dřeva jako přírodního materiálu.

Neopracované a neošetřené dřevo (kromě základových trámů) podléhá šednutí, jakmile je i kratší dobu ponecháno bez ochrany, a také může modrat a plesnivět. K ochraně dřevěných detailů u vašeho zahradního domku musíte okamžitě přistoupit k povrchové ochraně dřeva.

Doporučujeme, abyste předem opatřili podlahová prkna bezbarvou impregnací dřeva, zejména pak spodní strany desek, ke kterým, jakmile je chatka sestavena, již nebude přístup. Pouze tento krok zabrání pronikání vlhkosti.

Také rozhodně doporučujeme, abyste předem opatřili dveře a okna impregnací dřeva, a to jak vnitřní, tak i venkovní stranu! Jinak se dveře a okna mohou začít kroutit.

Po dokončení montáže domku doporučujeme nátěr pro definitivní vrchní ochranu proti povětrnostním vlivům, který bude chránit dřevo před vlhkostí a UV zářením.

Při natírání používejte co nejkvalitnější nástroje a barvy, postupujte podle návodu od výrobce k nanášení nátěrové hmoty a podle bezpečnostních pokynů výrobce a návodu k použití. Nikdy nezačínajte natírání povrchu v silném slunečním světle nebo během deštivého počasí. Poradte se s odborníkem o nátěrových hmotách vhodných pro nepracované měkké dřevo a postupujte podle pokynů výrobce nátěrové hmoty.

Po správném provedení povrchové úpravy se životnost vašeho zahradního domku podstatně zvýší. Doporučujeme vám důkladně jednou za šest měsíců domek přezkontrolovat.

2 Příprava k montáži

Nástroje a příprava komponentů

Pro sestavení zahradního domku budete potřebovat následující nástroje:



montážní podpěry



žebřík



kladivo



vodováha



šroubovák



pila



nůž



metr



kleště



vrtačka

DOPORUČENÍ: Aby se zabránilo zadření třísky, doporučujeme během montáže nosit odpovídající ochranné rukavice.



Přejeme Vám mnoho úspěchů s montáží zahradního domku a hodně potěšení s tímto domkem po mnoho let!

1 Informacje ogólne



Szanowny kliencie,

Cieszymy się, że zdecydowali się Państwo na zakup naszego domku ogrodowego.

Przed rozpoczęciem montażu należy dokładnie zapoznać się z instrukcją. Przestrzeganie instrukcji pozwoli uniknąć problemów i zaoszczędzi czas.

Zalecenia:

- Przed montażem domku opakowanie należy przechowywać w suchym miejscu, nie bezpośrednio na ziemi i zabezpieczone przed wpływem warunków atmosferycznych (wilgocią, słońcem, itp.) Nie należy przechowywać opakowania z domkiem w pomieszczeniu ogrzewanym!
- Przy wyborze miejsca na domek należy sprawdzić, czy domek nie będzie narażony na wpływ ekstremalnych warunków pogodowych (obfite opady śniegu lub silne wiatry). W przeciwnym razie należy go przytwierdzić (np. za pomocą kotew) do podłoża.



Gwarancja

Dom wykonano z wysokiej jakości jodły i sprzedawany w stanie surowym (nie zaimpregnowanym). Jeśli, pomimo naszych dokładnych inspekcji, będą Państwo niezadowoleni z produktu, prosimy o wypełnienie karty kontrolnej i zwrócenie jej producentowi wraz z dowodem zakupu.

UWAGA: Należy zachować całą dokumentację załączoną do opakowania domku. Numer kontrolny domu znajduje się na karcie kontrolnej. Zajmujemy się wyłącznie reklamacjami, do których dołączono numer seryjny domku!

Gwarancja nie obejmuje:

- Osobliwości drewna jako surowca naturalnego
- Pomalowanych części drewnianych (zabezpieczonych środkiem ochrony drewna)
- Elementów drewnianych zawierających całe gałęzie, które nie zagrażają stabilności domu
- Różnicy w odcieniach koloru spowodowanej różną strukturą drewna, która nie wpływa na żywotność drewna
- Elementów drewnianych z drobnymi pęknięciami, szczelinami (spowodowanymi wysychaniem), które nie wpływają na strukturę domku
- Skręceń elementów drewnianych, które nie przeszkadzają w montażu
- Położonych w niewidocznym miejscu nieostruganych połączeń, różnic w kolorze ani ubytków płyt dachowych i podłogi
- Reklamacji wynikających z niewłaściwego montażu domku ani osiadania domku wskutek niewłaściwie położonego fundamentu
- Reklamacji usterek powstałych na skutek własnoręcznie wprowadzonych zmian konstrukcji, takich jak: odkształcenia elementów drewnianych lub drzwi/okien spowodowane niewłaściwym impregnowaniem drewna, zbyt sztywne przymocowanie zawiasów, ościeżnic przykręconych do ściany z bali, itp.

Reklamacje usterek objętych gwarancją uwzględniają wymianę wadliwych/uszkodzonych części. Inne roszczenia nie będą uwzględniane.



Malowanie i konserwacja domku ogrodowego

Drewno jest surowcem naturalnym, który ulega zmianom w zależności od warunków atmosferycznych. Drobne lub większe spękania, różnice w odcieniu oraz zmiany struktury nie są wadami, ale skutkiem wzrostu i specyfiki drewna jako surowca naturalnego.

Drewno nieobrobione (za wyjątkiem legarów fundamentowych) z czasem szarzeje, może przybrać barwę niebieską i zacząć pleśnieć. Aby zabezpieczyć drewniane elementy domku ogrodowego należy je jak najszybciej zabezpieczyć środkiem ochrony drewna.

Zalecamy wcześniejsze pomalowanie płyt podłogowych bezbarwnym impregnatem do drewna, szczególnie spodniej strony płyt, do których nie będzie dostępu po złożeniu całego domu. Jest to jedyny sposób na uniknięcie przenikania wilgoci.

Zdecydowanie zalecamy także pomalowanie drzwi i okien impregnatem do drewna, zarówno w środku jak i na zewnątrz. W przeciwnym razie drzwi i okna mogą się wyginać.

Po zakończeniu montażu zalecamy ostateczne pokrycie domku farbą o podwyższonej wytrzymałości na warunki atmosferyczne, która ochroni drewno przed wilgocią i promieniowaniem UV.

Do malowania należy używać wysokiej jakości narzędzi i farb, przestrzegać instrukcji producenta farby dotyczących malowania, bezpieczeństwa i użytkowania. Nigdy nie maluj powierzchni w pełnym słońcu ani w deszczu. W celu doboru farby odpowiedniej do miękkiego drewna nieobrobionego skonsultuj się ze specjalistą i przestrzegaj instrukcji producenta farby.

Żywotność domku znacznie wzrasta po właściwym pomalowaniu. Zalecamy dokonywanie dokładnego przeglądu domku co sześć miesięcy.

2 Przygotowanie do montażu

Narzędzia oraz przygotowanie elementów

Do montażu domku ogrodowego potrzebne są:



Przyrząd montażowy



drabina



młotek

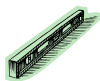

poziomica



śrubokręt



piła



nóż



taśma miernicza



kombinerki



wiertarka

WSKAZÓWKA: Na czas montażu zalecamy ubranie rękawic ochronnych, aby uniknąć skaleczeń drzazgami.



Życzymy udanego montażu domku ogrodowego i wiele radości z korzystania z niego przez wiele lat!

1 Bendroji informacija



Gerb. kliente,

džiaugiamės, kad nusprendėte įsigyti mūsų sodo namelį!

Prieš montuodami namelį, atidžiai perskaitykite surinkimo vadovą! Taip išvengsite problemų ir nešvaistysite laiko veltui.

Rekomendacijos

- Kol namelį visiškai surinksite, jo pakuotę laikykite sausoje vietoje (bet ne tiesiogiai ant žemės), apsaugotoje nuo oro sąlygų (drėgmės, saulės ir pan.). Nelaikykite namelio pakuotės šildomoje patalpoje!
- Rinkdamiesi sodo namelio vietą, įsitikinkite, kad jo neveiks blogos oro sąlygos (nesirinkite vietų, kur stipriai sninga ar pučia stiprus vėjas). Priešingu atveju namelį turite pritvirtinti (pavyzdžiui, tvirtinimo įtaisais) prie podirvio.



Garantija

Jūsų namelis pagamintas iš aukštos kokybės eglės ir yra tiekiamas natūralus (neapdorotas). Jei, nepaisant mūsų kruopštaus patikrinimo, turėtumėte skundų, pateikite užpildytą kontrolinį lapą ir pirkimo sąskaitą faktūrą gaminio pardavėjui.

DĖMESIO: būtinai išsaugokite dokumentus, pateikiamus namelio pakuotėje! Kontrolinis lapas apima namelio kontrolinį numerį. Skundus galime peržiūrėti tik tuo atveju, jei pardavėjui pateikiate namelio kontrolinį numerį!

Garantija netaikoma:

- medienos, kaip natūralios medžiagos, ypatumams;
- jau dažytoms medinėms detalėms (apdirbtoms medienos apsaugos priemone);
- medinėms detalėms, turinčioms šakų, kurios nekelia pavojaus gaminio stabilumui;
- atspalvių pokyčiams, atsirandantiems dėl medienos struktūros skirtumų, kurie neturi įtakos medienos naudojimo trukmei;
- medinėms detalėms, kuriose yra (dėl džiuvimo) mažų įtrūkimų / tarpų, kurie neišnyksta ir neturi įtakos namelio struktūrai;
- susisukusioms medinėms detalėms, jeigu jas vis tiek įmanoma montuoti;
- stogo ir grindų lentoms, kurių paslėptuose paviršiuose gali būti neplanuotų sričių, spalvų skirtumų ir dilimo;
- skundams, atsiradusiems dėl nekompetentingo namelio montavimo būdo arba dėl namelio nusmukimo netinkamai paklojus pamatą;
- skundams, atsiradusiems dėl savavališkų namelio pakeitimų, pvz., medinių detalių ir (arba) durų / langų deformacijos dėl netinkamo medienos apdorojimo būdo, pernelyg standaus nuo audrų saugančių laikiklių pritvirtinimo, durų rėmų priveržimo prie sienos rąstų ir pan.

Skundai, kuriems taikoma garantija, patenkinami pakeičiant turinčią trūkumų / sugedusią medžiagą. Visi kiti reikalavimai nebus patenkinami!



Sodo namelio dažymas ir priežiūra

Mediena yra natūrali medžiaga, auganti ir prisitaikanti pagal oro sąlygas. Dideli ir maži įtrūkimai, atspalvių skirtumai ir pakitimai bei kintanti medienos struktūra nėra klaidos, o medienos augimo rezultatas ir medienos, kaip natūralios medžiagos, ypatumas.

Kurį laiką neliečiama neapdorota mediena (išskyrus pamatų sijas) tampa pilkšva ir gali pradėti mėlynuoti ar netgi pelyti. Kad apsaugotumėte medines savo sodo namelio detales, turite nedelsdami jas apdoroti medienos apsaugos priemone.

Rekomenduojame iš anksto padengti grindų lentas bespalve medienos impregnavimo priemone, ypač apatines lentų puses, kurių surinkę namelį nebesieksite. Tik tokiu būdu užkirsite kelią drėgmės prasiskverbimui.

Taip pat primygtinai rekomenduojame medienos impregnavimo priemone apdoroti duris ir langus tiek iš vidaus, tiek iš išorės! Priešingu atveju durys ir langai gali susisukti.

Surinkus namelį, rekomenduojame užbaigti nuo oro sąlygų apsaugančiais dažais, kurie apsaugos medieną nuo drėgmės ir UV spinduliuotės.

Dažymo darbams atlikti naudokite aukštos kokybės įrankius ir dažus bei laikykitės dažų naudojimo vadovo ir gamintojo saugos bei naudojimo instrukcijų. Niekada nedažykite paviršių stipriai šviečiant saulei arba lyjant lietu. Dėl dažų, tinkamų neapdorotai minkštai medienai, konsultuokitės su specialistu ir laikykitės dažų gamintojo instrukcijų.

Tinkamai nudažius, jūsų sodo namelio naudojimo laikas labai pailgės. Rekomenduojame kas šešis mėnesius kruopščiai patikrinti namelį.

2 Pasiruošimas surinkti

Įrankiai ir komponentų paruošimas

Sodo nameliui surinkti jums reikės šių įrankių:



pagalbinės
priemonės

surinkimo



kopėčios



kūjis



vandeninis gulsčiukas



atsuktuvus



pjūklas



peilis



matavimo juosta



replės



grąžtas

PATARIMAS: kad apsisaugotumėte nuo skeveldrų, rekomenduojame surenkant mūvėti atitinkamas apsaugines pirštines.



Linkime didelės sėkmės montuojant sodo namelį ir juo džiaugtis daugybę metų!

1 Vispārīga informācija



Cienījamais klient!

Mēs priecājamies, ka esat izvēlēties mūsu dārza mājiņu!

Lūdzu, pirms uzsākat mājas uzstādīšanu, rūpīgi izlasiet montāžas instrukciju! Tādējādi jūs izvairīsieties no problēmām un ietaupīsiet laiku.

Rekomendācijas:

- Mājas komplektāciju līdz pilnīgai uzstādīšanai uzglabājiēt sausā vietā, lai tā nesaskartos ar zemi un būtu pasargāta no laika apstākļu ietekmes (mitruma, saules u. tml.). Neuzglabājiēt mājas komplektāciju apsildāmās telpās!
- Izvēloties dārza mājiņas būvēšanas vietu, pārliecinieties, ka tā netiks pakļauta ekstrēmiem laika apstākļiem (vietās, kas pakļautas spēcīgiem snieguputeņiem vai vējiem); pretējā gadījumā jums jānostiprina māja (piemēram, ar enkuriem) pie augsnes apakškārtas.



Garantija

Jūsu māja ir izgatavota no augstas kvalitātes egles koksnes un piegādāta dabiskā (neapstrādātā) formā. Ja, neraugoties uz mūsu rūpīgajām pārbaudēm, jums rodas sūdzības, lūdzu, iesniedziet produkta pārdevējam aizpildītu pārbaudes veidlapu un pirkuma rēķinu.

UZMANĪBU: Lūdzu, noteikti saglabājiēt mājas komplektācijā ietvertos dokumentus! Uz pārbaudes veidlapas norādīts mājas pārbaudes numurs. Sūdzības mēs varam izskatīt tikai tad, ja jūs pārdevējam iesniedzat mājas pārbaudes numuru!

Garantija neietver:

- Koka kā dabīga materiāla īpatnības
- Koka detaļas, kas jau ir nokrāsotas (apstrādātas ar koksnes antiseptiķi)
- Koka detaļas, kas satur zaru vietas, bet neapdraud mājas stabilitāti
- Krāsas toņa atšķirības, ko izraisa atšķirīga koka struktūra un kas neietekmē koka ilgmūžību
- Koka detaļas, kurām (žūšanas rezultātā) ir izveidojušās nelielas plaisas/spraugas, kas nav pāršķēlušas detaļu un neietekmē mājas konstrukciju
- Savēpušās koka detaļas, ja tās aizvien ir iespējams uzstādīt
- Jumta un grīdas dēļus, kuriem uz neredzamajām virsmām ir palikušas nenoveļētas, nodilušas vai atšķirīgas krāsas zonas
- Sūdzības, kas radušās nekompetentas mājas montāžas dēļ vai mājas nosēšanās nekompetenti būvētu pamatu dēļ
- Sūdzības, kas radušās, ieviešot pašrocīgas izmaiņas mājas konstrukcijā, piemēram, koka detaļu un logu/durvju deformēšanās nekompetentas koka apstrādes dēļ, pārāk cieši piestiprinot vēja atgāžņus, pieskrūvējot durvju rāmi pie sienu balķiem u. tml.

Garantijā ietvertās sūdzības tiek apmierinātas, aizvietojoat defektīvās/bojātās detaļas. Visas pārējās prasības netiek apmierinātas!



Dārza mājiņas krāsošana un uzturēšana

Koks ir dabisks materiāls, kas aug un piemērojas laika apstākļiem. Lielākas un mazākas plaisas, atšķirības un izmaiņas krāsas tonī, kā arī mainīga koka struktūra nav defekti, bet koka augšanas un koka kā dabīga materiāla īpatnību rezultāts.

Neapstrādāts koks (izņemot grīdas sijas) pēc kāda laika kļūst pelēcīgs un var palikt zilgans un sapelēt. Lai pasargātu savas dārza mājiņas koka detaļas, jums tās nekavējoties jāapstrādā ar koksnes aizsarglīdzekli.

Mēs iesakām uzreiz nokrāsot grīdas dēļus ar bezkrāsainu koksnes impregnēšanas līdzekli, jo sevišķi dēļu sānus, kuriem jūs vairs nevarēsiet piekļūt, kad māja būs samontēta. Tikai tādējādi jūs varat novērst mitruma iesūkšanos.

Mēs noteikti iesakām ar koka impregnēšanas līdzekli apstrādāt arī durvis un logus, turklāt gan no ārpuses, gan iekšpuses! Pretējā gadījumā durvis un logi var savērties.

Kad mājas montāža ir pabeigta, mēs iesakām to nokrāsot ar pret laika apstākļiem izturīgu krāsu, kas pasargās koku no mitruma un UV radiācijas.

Krāsošanai izmantojiet augstas kvalitātes instrumentus un krāsas, ievērojiet krāsas uzklāšanas instrukcijas un ražotāja drošības un lietošanas norādījumus. Nekad nekrāsojiet virsmas spēcīgā saules gaismā vai lietainā laikā. Par neapstrādātai skujkoksnei piemērotu krāsu konsultējieties ar speciālistu un ievērojiet krāsas ražotāja instrukcijas.

Atbilstoša nokrāsošana ievērojami pagarinās jūsu dārza mājiņas kalpošanas laiku. Mēs iesakām rūpīgi pārbaudīt māju reizi sešos mēnešos.

2 Sagatavošanās montāžai

Instrumenti un detaļu sagatavošana

Lai samontētu dārza mājiņu, jums būs nepieciešami šādi instrumenti:



montāžas instrumentu komplekts



kāpnes



āmurs



līmeņrādis



skrūvgriezis



zāģis



nazis



mērlente



knaibles



urbis

PADOMS: Lai izvairītos no skabargām, mēs montāžas procesa laikā iesakām valkāt atbilstošus aizsargcimdus.



Mēs novēlam jums veiksmi, uzstādot dārza mājiņu, un daudz prieka, mitinoties šajā mājiņā, vēl ilgus gadus!

1 Общая информация



Уважаемый клиент!

мы рады, что Вы приняли решение в пользу нашего садового дома!

Просим Вас очень внимательно прочитать инструкцию по монтажу, прежде чем Вы приступите к сборке дома! Так Вы сможете избежать ненужных потерь времени.

Рекомендации:

- Сохраняйте комплект деталей дома до полной сборки в сухом месте без прямого контакта с землей, а также защищенным от климатических воздействий (влажность, солнце и пр.). Не храните комплект деталей дома в натопленном помещении!
- При выборе места для садового дома следите за тем, чтобы дом не находился под воздействием экстремальных климатических условий (сильный снегопад или ветер), в противном случае Вам необходимо закрепить дом (напр., при помощи анкеров) к поверхности основания.

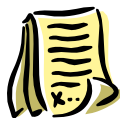

Гарантия

Ваш дом изготовлен из высококачественной еловой древесины и поставляется в натуральном виде (без обработки). Если, несмотря на наш тщательный контроль, у Вас появятся жалобы, предъявите продавцу товара заполненный контрольный лист и чек на покупку.

ВНИМАНИЕ: Просим обязательно сохранить приложенную к дому документацию! В контрольном листе Вы найдете контрольный номер дома. Жалобы учитываются только в том случае, если Вы передадите продавцу контрольный номер дома!

гарантией не покрываются:

- Особенности, обусловленные древесиной как природным материалом
- Детали, которые уже окрашены (обработаны средством для защиты древесины)
- Детали, в которых попадаются целые сучки, которые не вредят стабильности дома
- Обусловленные разницей в структуре древесины разные цветовые тона, которые не влияют на срок службы древесины
- Детали, в которых имеются маленькие (обусловленные высыханием) трещинки, которые не являются сквозными и не влияют на конструкцию дома
- Скрученные деревянные детали, если их все же можно установить
- Доски кровли и пола, на невидимых поверхностях которых могут встречаться необработанные места, разница в цвете и обзоле
- Жалобы, обусловленные непрофессиональным расположением дома, или проседание дома в результате непрофессионально подготовленного фундамента
- Жалобы, обусловленные внесенными по собственной инициативе изменениями в конструкции дома, напр., искривление деревянных деталей и дверей/окон в результате непрофессиональной обработки; слишком жесткое закрепление плавающей планки, прикручивание дверных рам к стенным деталям и пр.

Удовлетворение попадающих под гарантию жалоб ограничивается заменой отсутствующего/некачественного материала. Все прочие требования исключены!



Покраска и обслуживание садового дома

Древесина является природным материалом, который увеличивается или уменьшается в объеме в зависимости от погодных условий. Большие и маленькие трещины, разница в цветовых тонах и изменение тонов, а также изменения в структуре древесины не считаются дефектами, а являются результатом роста дерева и своеобразием древесины как природного материала.

Необработанная древесина (за искл. фундаментных брусьев) через некоторое время становится серою, может посинеть и заплесневеть. Чтобы защитить деревянные детали своего садового дома, Вы должны незамедлительно обработать их защитным средством для древесины.

Рекомендуем предварительно покрыть напольные доски бесцветным средством для пропитки дерева, особенно нижнюю сторону досок, к которой после монтажа дома доступа больше не будет. Только в таком случае можно остановить проникновение влаги.

Рекомендуем обязательно обработать средством для пропитки древесины также двери и окна. Важно обязательно обработать окна и двери как изнутри, так и снаружи! В противном случае они могут искривиться.

После монтажа дома рекомендуем при окончательной отделке использовать для защиты от погодных условий краску, которая защищает древесину от влаги и ультрафиолетового излучения.

При покраске используйте высококачественные рабочие инструменты и краски, следуйте инструкции по использованию краски, а также инструкциям производителя по безопасности и эксплуатации. Никогда не красьте под жарким солнцем или в дождливую погоду. Получите у специалиста консультацию в части красок, предназначенных для хвойной древесины, а также соблюдайте инструкции производителя краски.

Правильная покраска дома значительно продлит срок службы Вашего садового дома. Через каждые полгода рекомендуем Вам внимательно осматривать дом.

2 Подготовка к монтажу

Подготовка рабочих инструментов и деталей

Для монтажа садового дома Вам понадобятся следующие рабочие инструменты:



помощник по монтажу



лестница-стремянка



молоток



уровень



отвертка



пила



нож



рулетка



щипцы



сверло

РЕКОМЕНДАЦИЯ: Чтобы избежать возможных заноз, рекомендуем во время монтажа надевать соответствующие защитные перчатки.



Желаем Вам успеха в установке садового дома и много радости на долгие годы!

1 Üldinfo



Lugupeetud klient,

Meil on hea meel, et olete otsustanud meie aiamaja kasuks!

Palume Teil enne maja paigaldamisega alustamist montaažjuhend väga hoolikalt läbi lugeda! Nii väldite probleeme ja asjatut ajakulu.

Nõuanded:

- Säilitage majapakki kuni lõpliku kokkumonteerimiseni kuivas kohas, vältides otsesest kokkupuudet maapinnaga ning kaitstuna ilmastikutingimuste (niiskus, päike jms) eest. Ärge hoidke majapakki kuumaks köetud ruumis!
- Aiamaja asukoha valikul jälgige, et maja ei jääks ekstreemsete ilmastikuolude meelevalda (tugeva lumesaju või tuulega piirkonnad), vastasel korral peaksite maja kinnitama (nt ankrute abil) aluspinnase külge.



Garantii

Teie maja on valmistatud kõrge kvaliteetsest kuusepuidust ja tarnitakse naturaalsel (töötlemata) kujul. Kui hoolimata meie põhjalikust kontrollist peaks kaebusi esinema, esitage kauba müüjale täidetud kontroll-leht ja ostuarve.

TÄHELEPANU: Palume kindlasti säilitada maja juurde kuuluv dokumentatsioon! Kontroll-lehelt leiate maja kontrollnumbri. Kaebustega saab arvestada ainult juhul, kui Te edastate müüjale maja kontrollnumbri!

Garantii alla ei kuulu:

- Puidu kui looduslikust materjali loomulikust käitumisest ja iseärasustest tulenevad muutused – paisumine, kahanemine ning toonierinevused
- Detailid, mis on juba värvitud (puidukaitsevahendiga töödeldud)
- Detailid, milles esineb terveid/sissekasvanud oksid, mis ei kahjusta maja stabiilsust
- Puidu struktuuri erinevustest tingitud erinevad värvitoonid, mis ei mõjuta puidu eluiga
- Detailid, milles on (kuivamisest tingitud) väikesed praod/lõhed, mis ei ole läbivad ning ei mõjuta maja konstruktsiooni stabiilsust
- Väändunud puitdetailid
- Katuse- ja põrandalauad, mille mitterahuldavatel pindadel võib esineda hõõveldamata pinda, värvierinevusi ja poomkantsust
- Kaebused, mille on põhjustanud maja asjatundmatu paigaldus või maja vajumine asjatundmatult valmistatud vundamendi tõttu
- Kaebused, mis on põhjustatud omaalgatuslikest muudatustest maja juures, nagu nt puitdetailide ja uste/akende kõveraks tõmbumine asjatundmatu puidu töötlemise tõttu; tormiliistude liiga jäik kinnitamine, ukseraamide krüvimine seinadetailide külge jms.

Garantii alla kuuluvate kaebuste rahuldamine piirdub puuduva/vigase materjali väljavahetamisega. Kõik muud nõudmised on välistatud! Tootja jätab endale õiguse toote tehnilisteks muudatusteks.



Aiamaja värvimine ja hooldus

Puit on looduslik materjal ning kasvab ja kahaneb sõltuvalt ilmastikuoludest. Suured ja väikesed praod, värvitoonide erinevused ning muutused, samuti muutuv puidustruktuur ei ole vead, vaid on puu kasvamise tulemus ning puidu kui loodusliku materjali omapära.

Töötlemata puit (va vundamendiprussid) muutub seistes mõne aja pärast hallikaks, võib tõmbuda siniseks ja minna hallitama. Et kaitsta oma aiamaja puitdetaile, peate Te need koheselt puidukaitsevahendiga töötleva.

Soovitame katta põrandalauad eelnevalt värvitu puiduimmutusvahendiga, eriti laudade alumised küljed, millele pärast maja kokkumonteerimist enam ligi ei pääse. Ainult sel juhul saab takistada niiskuse sisseimbumist.

Soovitame kindlasti töödelda puiduimmutusvahendiga ka uksi ja aknaid. Oluline on uksi-aknaid töödelda kindlasti nii seest- kui ka väljastpoolt! Vastasel korral võivad nad kõveraks tõmbuda.

Pärast maja montaaži soovitame lõplikul viimistlusel kasutada ilmastikuolude kaitseks värvi, mis kaitseb puitu niiskuse ja UV-kiirguse eest.

Värvimisel kasutage kõrgekvaliteedilisi tööriistu ja värve, järgige värvide kasutusjuhendit, tootja ohutus- ja kasutamisujuhiseid. Ärge kunagi värvige otsese päikese käes ega vihmase ilmaga. Laske end erialaspetsialistil nõustada töötlemata okaspuu jaoks mõeldud värvide osas ja järgige värvitootja juhiseid.

Reeglipärane maja värvimine pikendab oluliselt Teie aiamaja eluiga. Kord poole aasta järel soovitame Teil maja hoolikalt üle vaadata.

2 Ettevalmistus montaažiks

Töövahendid ja detailide ettevalmistus

Aiamaja montaažiks on Teil vaja järgmisi tööriistu:



montaažiabiline



redel



haamer

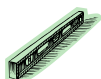

vesilood



kruvikeeraja



saag



nuga



mõõdulint



tangid



puur

NÕUANNE: Vältimaks võimalikke pinde, soovitame kanda monteerimise ajal vastavaid kaitsekindaid.