

*BARBADOS 5*  
*Art.No. 7010702*

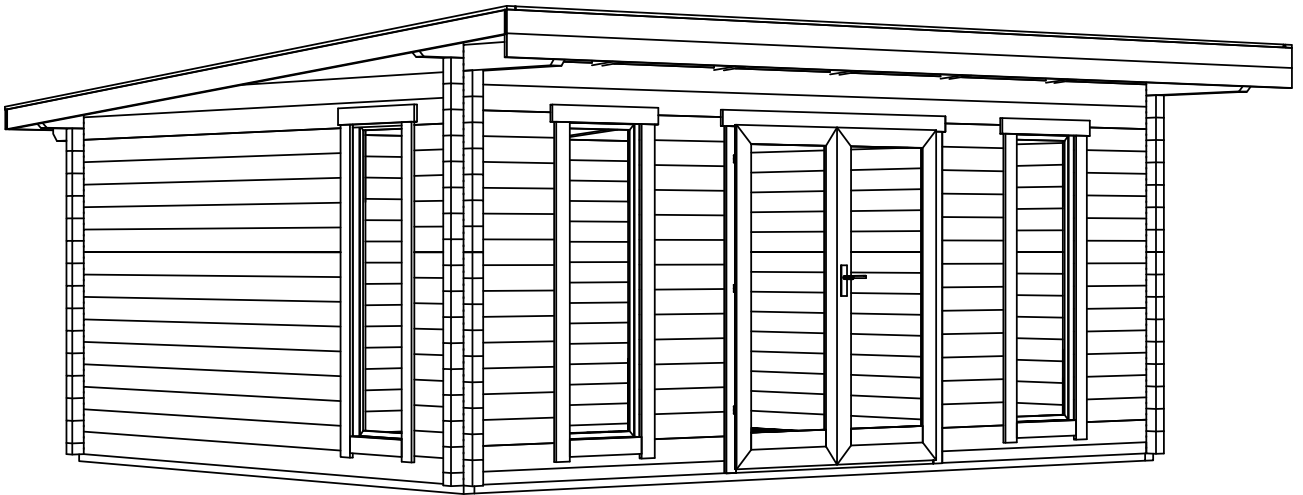

BARBADOS 5, Art.Nr. 7010702  
 GROUNDPLAN - GRUNDPLAN - PLAN DE MASSE

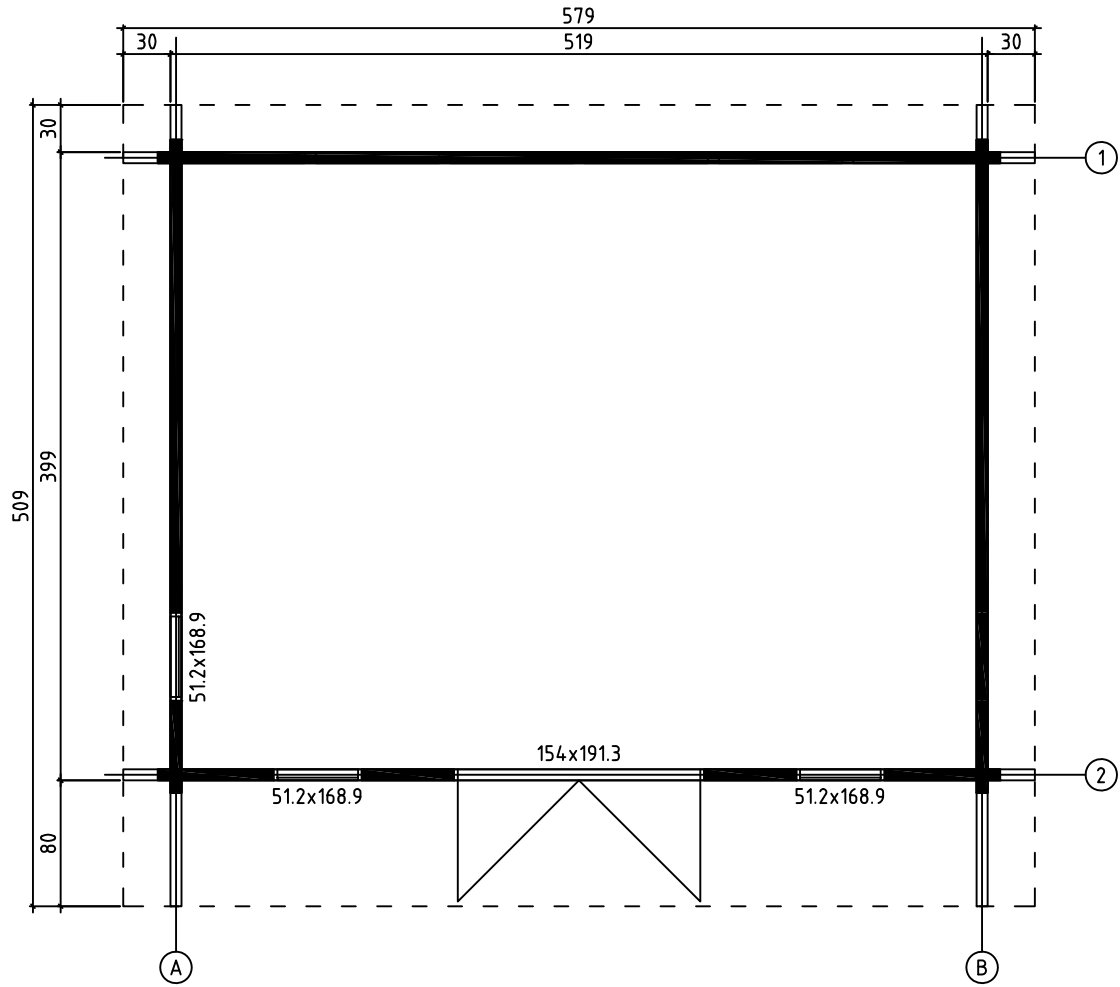

FOUNDATION - FUNDAMENT - FONDATION

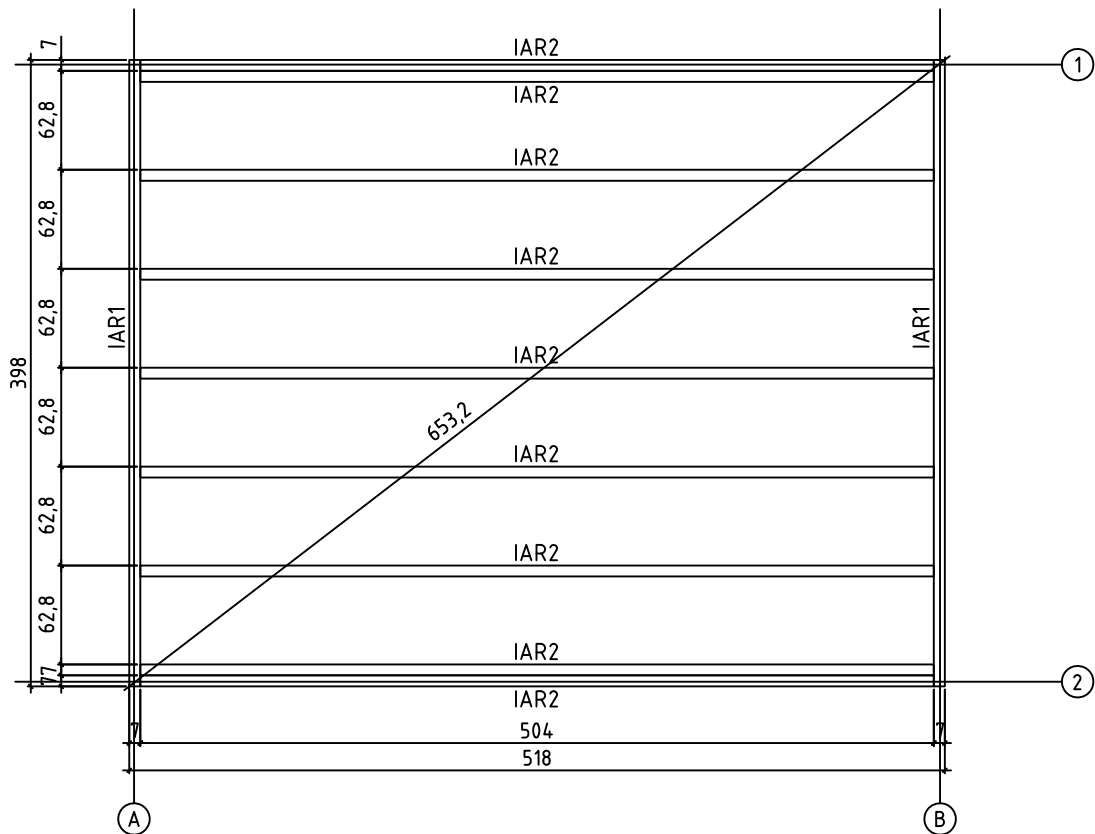

BARBADOS 5, Art.Nr. 7010702  
RAFTER - DACHSPARREN - CHEVRON

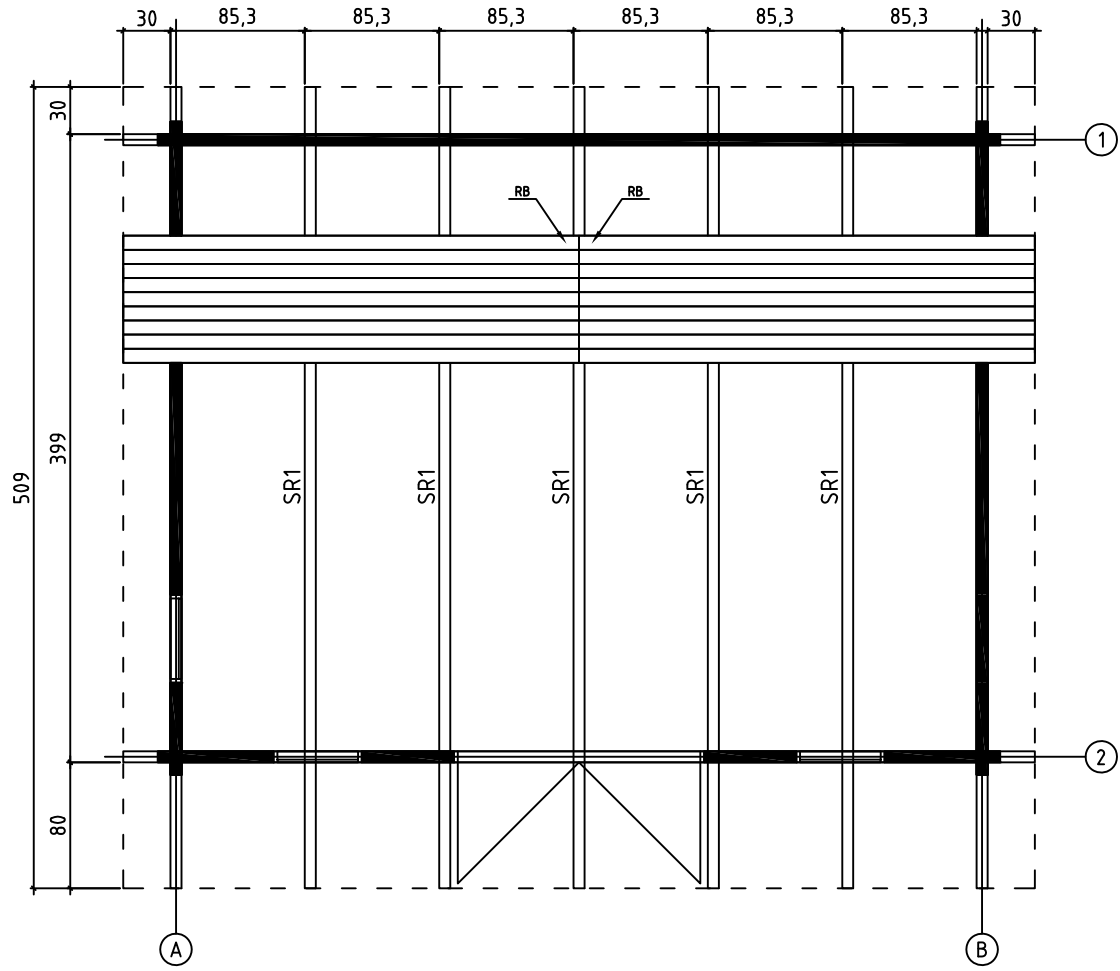

FLOOR BOARDS - FUSSBODENBRETTER - PLAN POSE PLANCHER

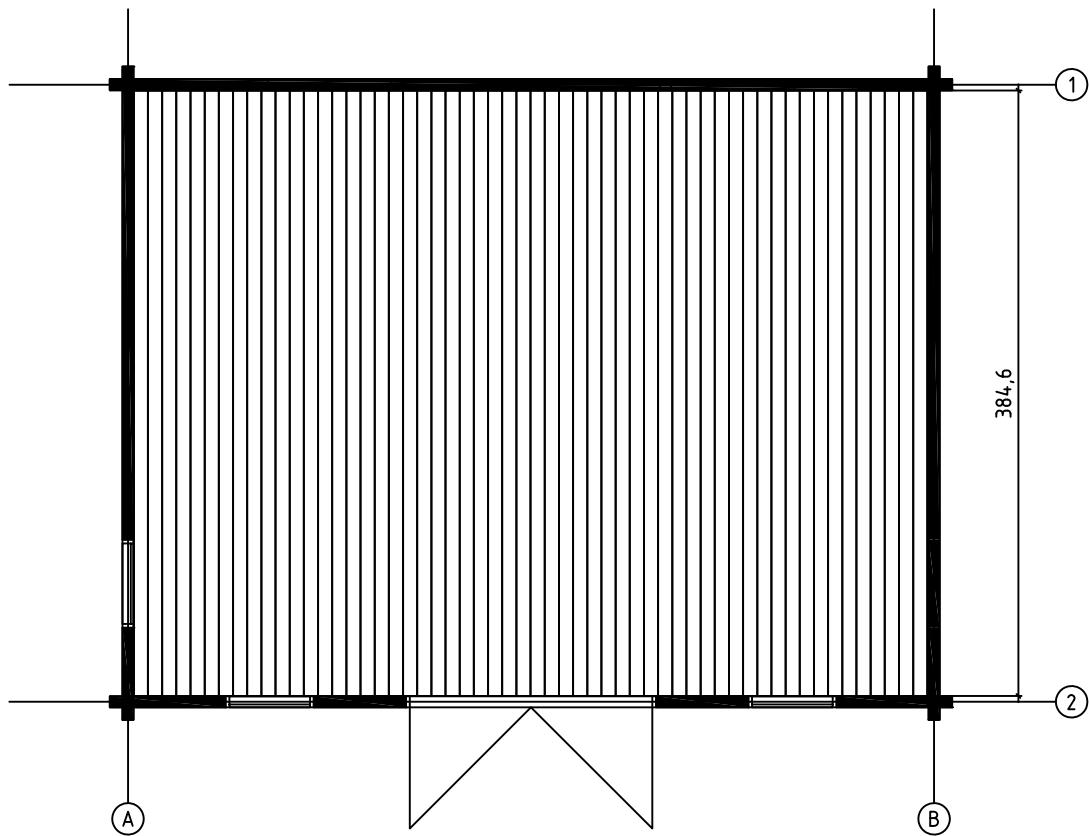

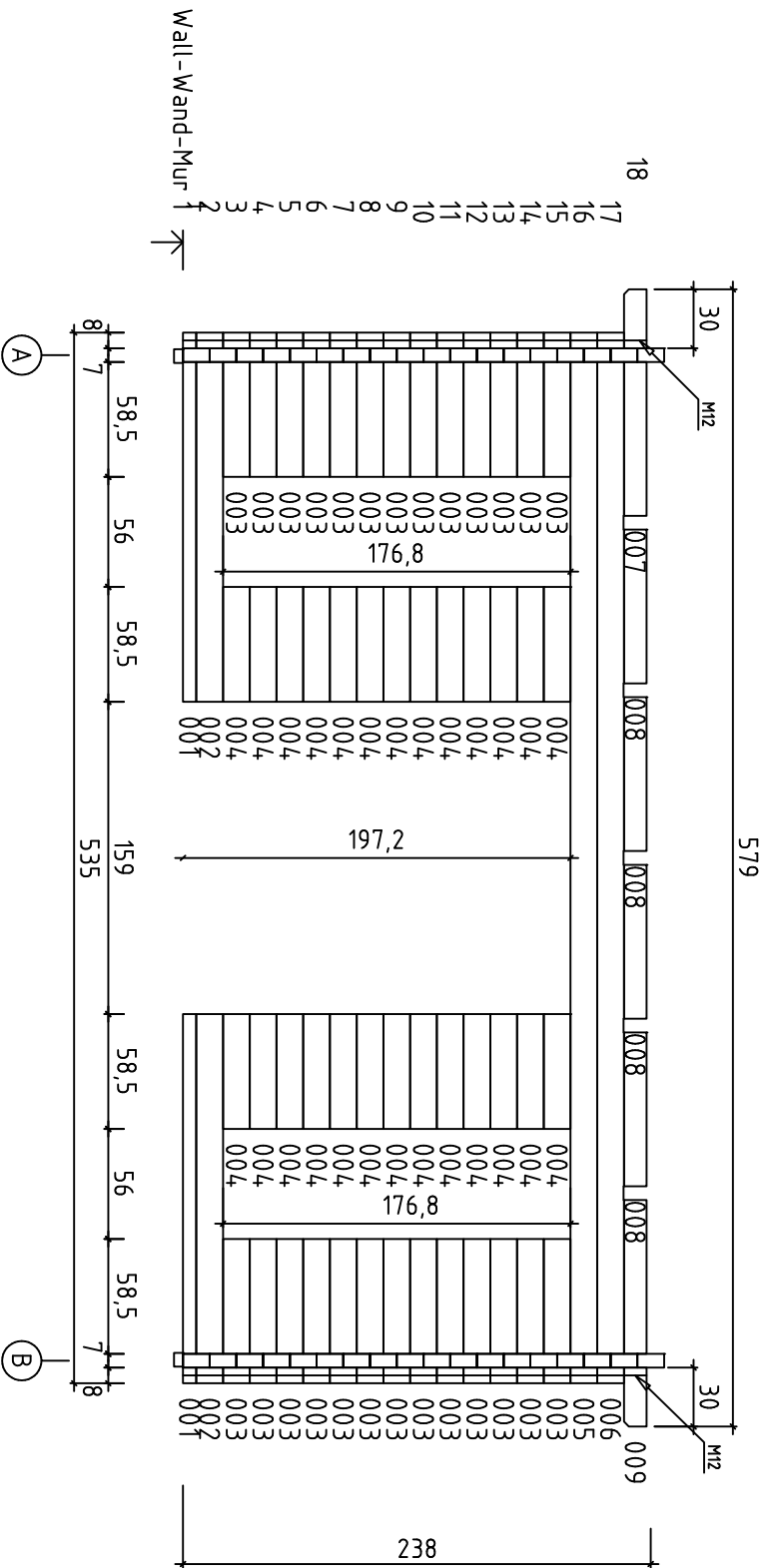



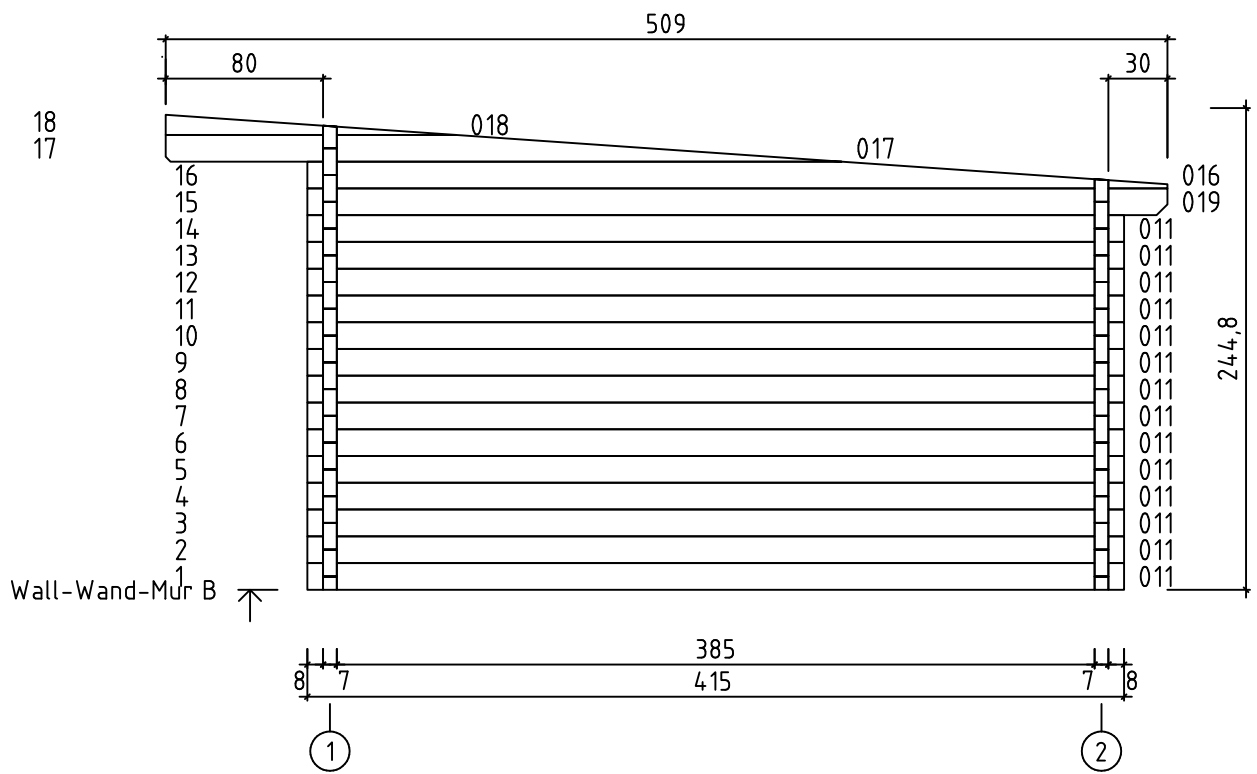
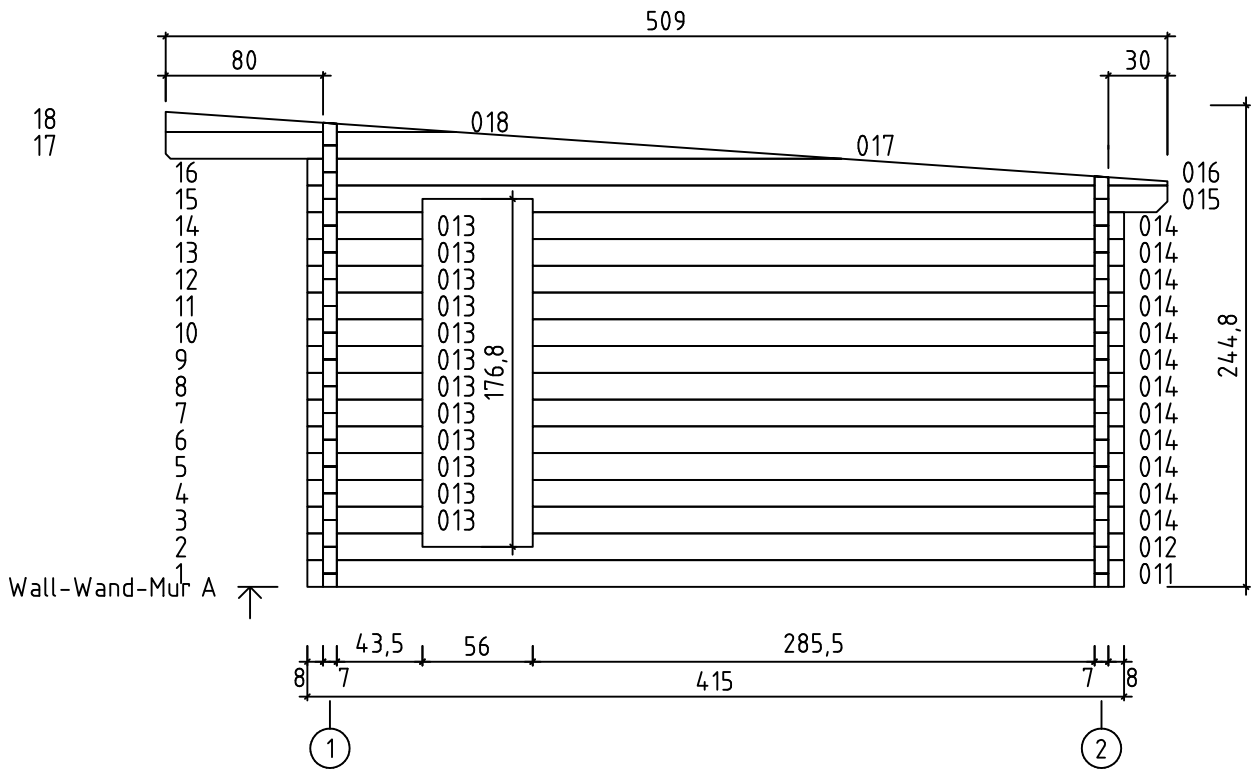

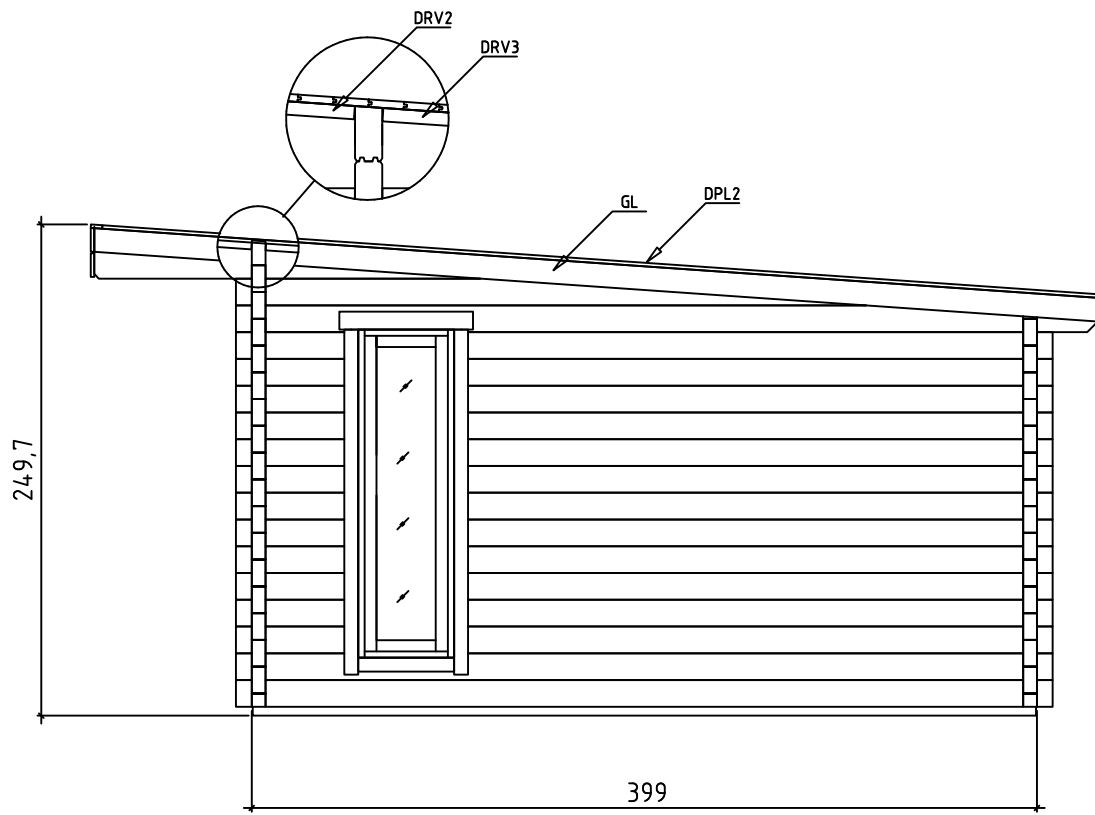
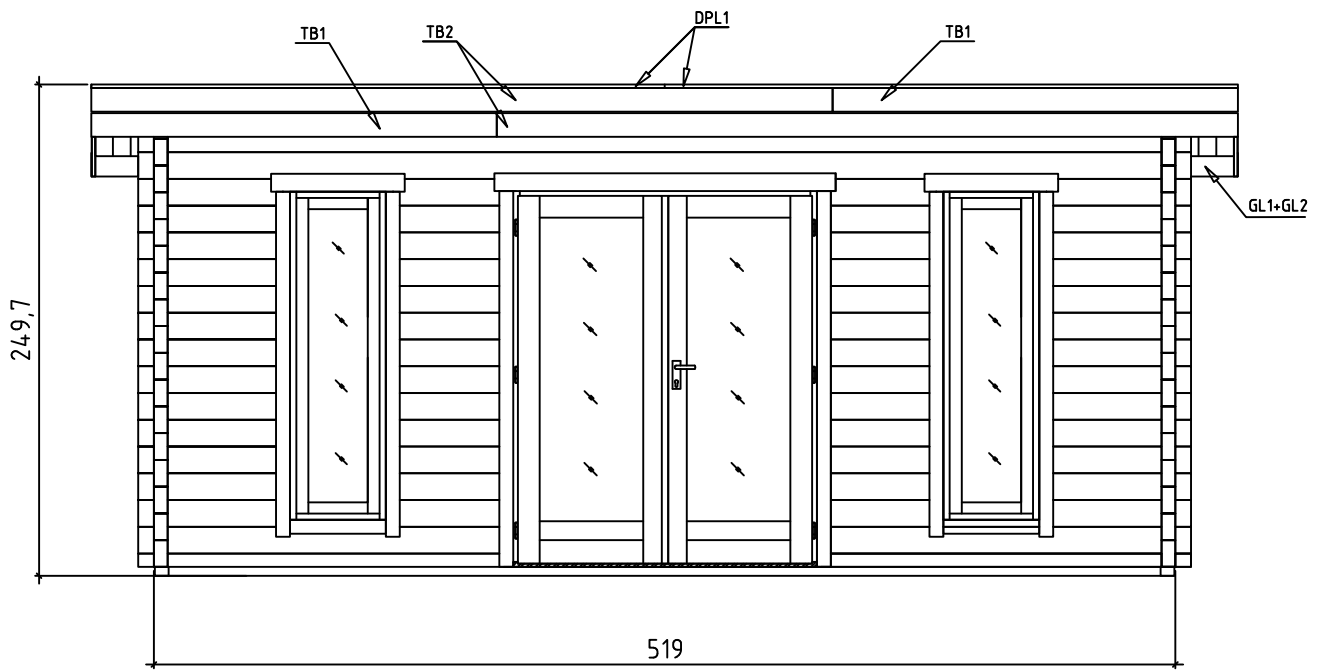

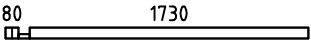
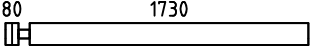
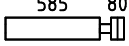

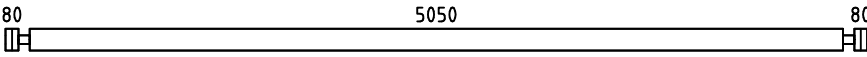
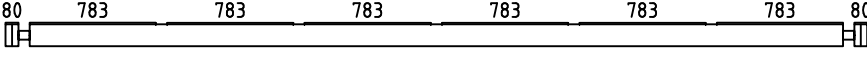
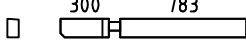
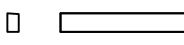
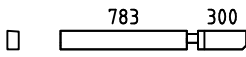
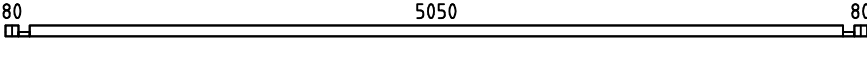
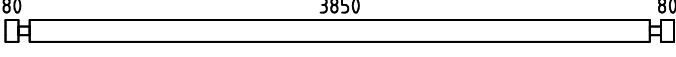
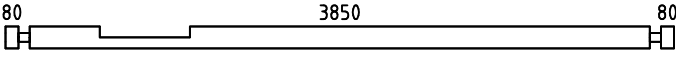

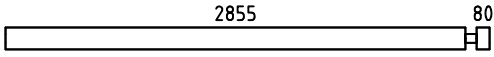
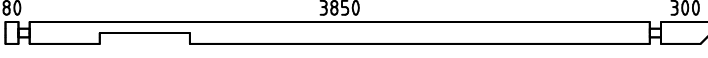
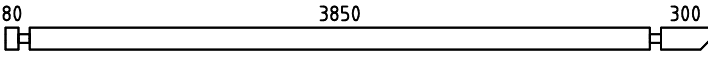
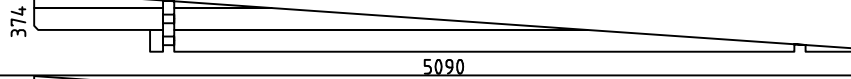
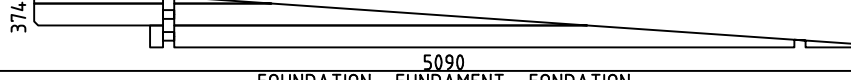
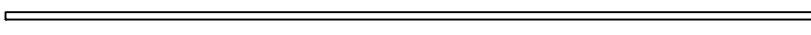
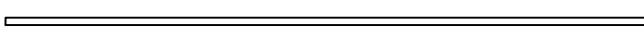
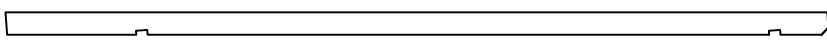











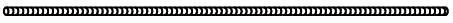



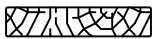
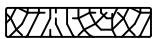



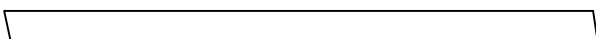





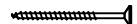
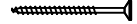



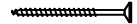

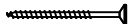
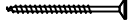
Pos	BARBADOS 5, Art.Nr. 7010702 Piece list - Stückliste - Liste des pieces	Q.	P (mm)	L (mm)
001		2	70x68	1880
002		2	70x136	1880
003		26	70x136	735
004		26	70x136	585
005		14	70x136	5350
006		2	70x136	5350
007		2	70x115	1153
008		8	70x115	783
009		2	70x115	1153
010		1	70x68	5350
011		15	70x136	4150
012		1	70x136	4150
013		12	70x136	585
014		12	70x136	3005
015		1	70x136	4370
019		1	70x136	4370
WA-1		1		
WB-1		1		
IAR2	FOUNDATION - FUNDAMENT - FONDATION 	9	70x45	5040
IAR1	FOUNDATION - FUNDAMENT - FONDATION 	2	70x45	3980
SR1	RAFTER - DACHSPARREN - CHEVRON 	5	70x140	5112
FB	FLOOR BOARDS - FUSSBODENBRETTER - LAME DE PLANCHER 	57	90x18	3846
RB	ROOF BOARDS - DACHBRETTER - VOLIGES 	114	90x18	2895
	FLOOR FILLET-FUSSBODENLEISTE - CORNIERE DE FINITION DU PLANCHER 		18x18	17.8 m.
DPL1	ROOFING FELT FILLET - DACHPAPPENLEISTE - BAGUETTE DE FIXATION DU FEUTRE BITUMEUX 	2	18x58	2915

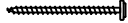
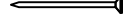

Pos	BARBADOS 5, Art.Nr. 7010702 Piece list - Stückliste - Liste des pieces	Q.	P (mm)	L (mm)
DPL2	ROOFING FELT FILLET - DACHPAPPENLEISTE - BAGUETTE DE FIXATION DU FEUTRE BITUMEUX 	2	18x58	5080
M12	TREADED ROD M12 - GEWINDESTANGE M12 - TIGE FILETÉE M12 	2		90
M12	TREADED ROD M12 - GEWINDESTANGE M12 - TIGE FILETÉE M12 	2		390
M12	TREADED ROD M12 - GEWINDESTANGE M12 TIGE FILETÉE M12 	4		2000
LPL	FIXING FILLET - FIXIRUNGSLEISTE - PROFIL DE FIXATION 	6	20x70	512
LPL	FIXING FILLET - FIXIRUNGSLEISTE - PROFIL DE FIXATION 	1	20x70	1540
LPL	FIXING FILLET - FIXIRUNGSLEISTE - PROFIL DE FIXATION 	6	20x70	1729
LPL	FIXING FILLET - FIXIRUNGSLEISTE - PROFIL DE FIXATION 	2	20x70	1933
TB1	EAVES BOARD - TRAUFBRETT - BANDEAU DE TOIT 	3	18x120	2062
TB2	EAVES BOARD - TRAUFBRETT - BANDEAU DE TOIT 	3	18x120	3768
DRV1	ROOF EDGE REINFORCEMENT - DACHRANDVERSTÄRKUNG - CORNIERE DE RENFORT DE BORD DE TOIT 	2	28x34	297
DRV2	ROOF EDGE REINFORCEMENT - DACHRANDVERSTÄRKUNG - CORNIERE DE RENFORT DE BORD DE TOIT 	2	28x34	798
DRV3	ROOF EDGE REINFORCEMENT - DACHRANDVERSTÄRKUNG - CORNIERE DE RENFORT DE BORD DE TOIT 	2	28x34	3850
GL	GABLE MOULDING - GIEBELLEISTE PLANCHE DE RIVE 	2	18x120	5111
SH70	HAMMER BLOCK - SCHLAGHOLZ - CALLE DE FRAPPE 	1		
KL4	LENGTHENING BOLT FOR TREADED ROD - VERLÄNGERUNGSMUTTER FÜR GEWINDESTANGE - MANCHON DE RACCORDEMENT DE TIGE FILETÉE 	4		
KL1	DRIVE NUT TREADED ROD - EINSHLAGMUTTER FÜR GEWINDESTANGE - ÉCROU A FRAPPER POUR TIGE FILETÉE 	4		
KL2	NUT FOR TREADED ROD - MUTTER FÜR GEWINDESTANGE - ÉCROU POUR TIGE FILETÉE 	4		
KL3	PLAIN WASHER TREADED ROD - UNTERLEGSCHLEIBE FÜR GEWINDESTANGE - RONDELLE PLATE POUR TIGE FILETÉE 	4		
HS83	SCREW FOR FIXING FILLET - SCHRAUBEN FÜR FIXIRUNGSLEISTE VIS POUR PROFIL DE FIXATION 	63	3.5x50	
HS32	SCREW FOR EAVES BOARDS - SCHRAUBEN FÜR TRAUFBRETT VIS DE FIXATION POUR BANDEAU DE TOIT 	37	3.5x50	
HS16	SCREW FOR GABLE MOULDING - SCHRAUBEN FÜR GIEBELLEISTE VIS DE FIXATION POUR PLANCHE DE RIVE 	38	3.5x50	
HS26	SCREW FOR ROOF EDGE REINFORCEMENT - SCHRAUBEN FÜR DACHRANDVERSTÄRKUNG - VIS POUR RENFORT DE BORD DE TOIT 	28	4x40	
HS40	SCREW FOR 1. WALL BEAM - SCHRAUBE FÜR 1. BOHLENREIHE VIS DE FIXATION DES FONDATIONS 	8	5x120	
HS39	SCREW FOR FUNDAMENT - SCHRAUBEN ZUR BEFESTIGUNG FUNDAMENT - VIS POUR FONDATION 	13	5x120	

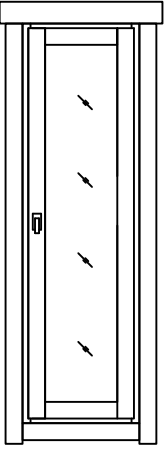
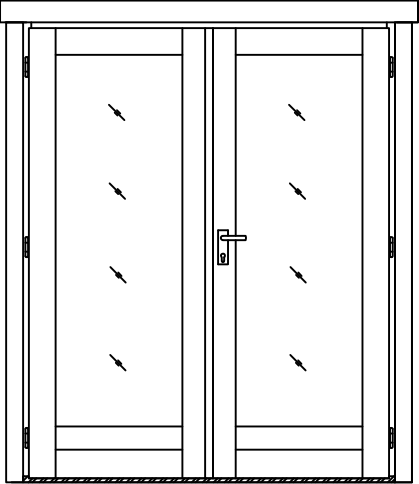
Pos	BARBADOS 5, Art.Nr. 7010702 Piece list - Stückliste - Liste des pieces	Q.	P (mm)	L (mm)
HS42	SCREW FOR GABLE - SCHRAUBEN FÜR GIEBEL - VIS POUR FIXATION DES PIGNONS 	6	5x120	
HS48	SCREW FOR Pos. 007-009, SCHRAUBEN FÜR Pos. 007-009 VIS POUR Pos. 007-009 	24	6x180	
HS44	SCREW FOR RAFTER - SCHRAUBEN ZUR BEFESTIGUNG DACHSPARREN - VIS POUR CHEVRON 	10	6x180	
MS	SCREW FOR DOORSTEP - SCHRAUBEN FÜR TÜRSCHWELLE - VIS DE FIXATION DU SEUIL DE PORTE 	3	4.5x65	
NFD	ZN NAIL FOR ROOFING FELT FILLET - ZN NÄGEL FÜR DACHPAPPEN- LEISTE - POINTE POUR BAGUETTE FIXATION FEUTRE BITUMEUX 	50	2x40	
NFF	ZN NAIL FOR FILLETS - ZN NÄGEL FÜR LEISTEN - POINTE POUR CORNIERE 	38	1.4x40	
NF2	ZN NAIL FOR ROOF - ZN NÄGEL FÜR DACHBRETTER - POINTE POUR TOIT 	472	2x50	
NH1	ZN NAIL FOR FLOOR - ZN NÄGEL FÜR FUSSBODENBRETTER - CLOUS POUR PLANCHER 	522	2x50	
ORZ	MONTAGE SET FOR DOORS AND WINDOWS - MONTAGE-SET FÜR TÜREN UND FENSTER - JEU DE MONTAGE PORTES ET FENETRES	1		
3+ A.0P.b	WINDOW-FENSTER-FENETRE 552x1729 	3		
2+ TU.10P	DOOR-TÜR-PORTE 1580x1933 	1		

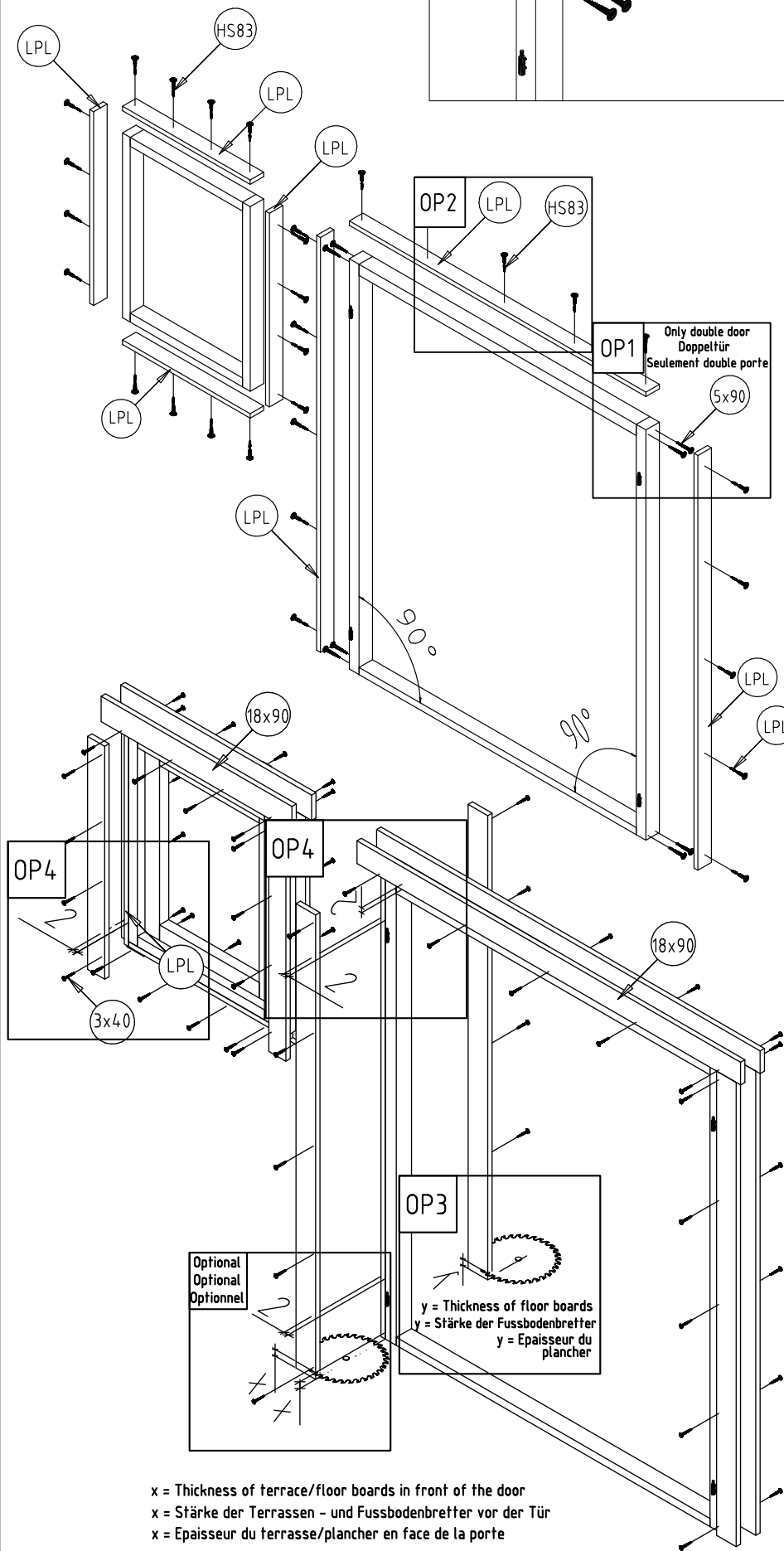
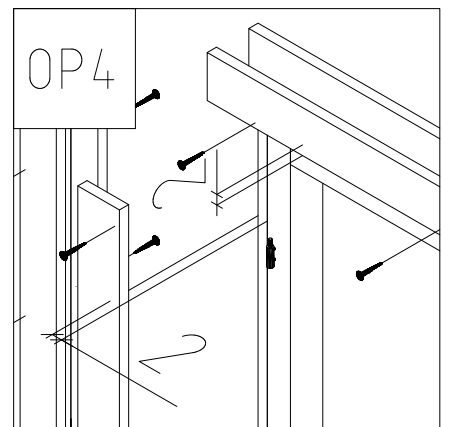
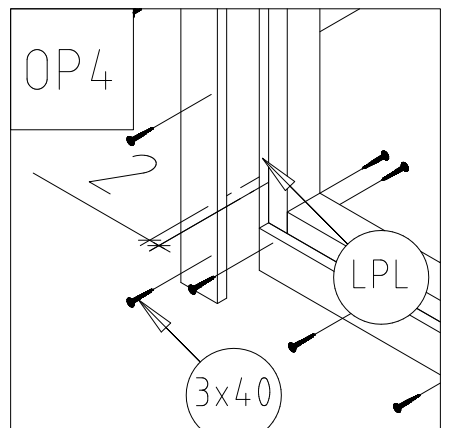
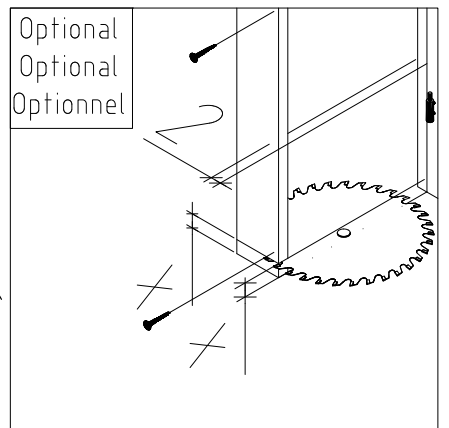
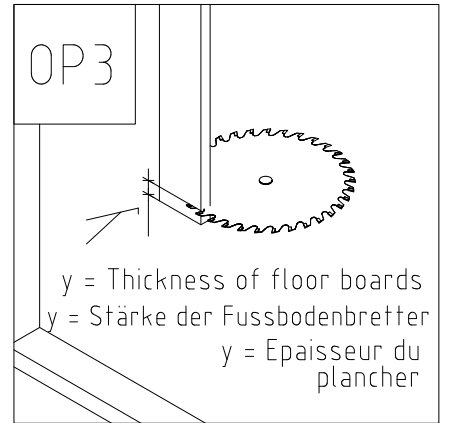
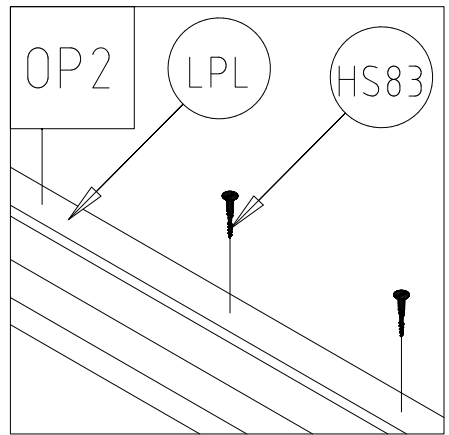
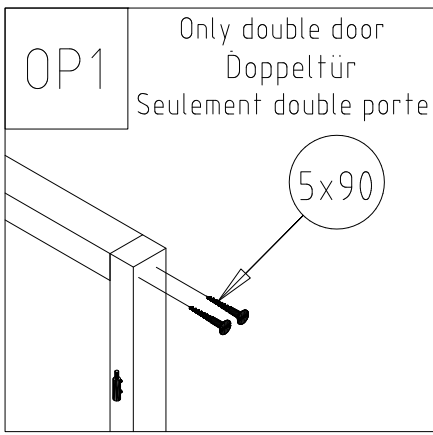

x = Thickness of terrace/floor boards in front of the door  
x = Stärke der Terrassen - und Fussbodenbretter vor der Tür  
x = Epaisseur du terrasse/plancher en face de la porte

