

Art. Nr. 4428902

1/20

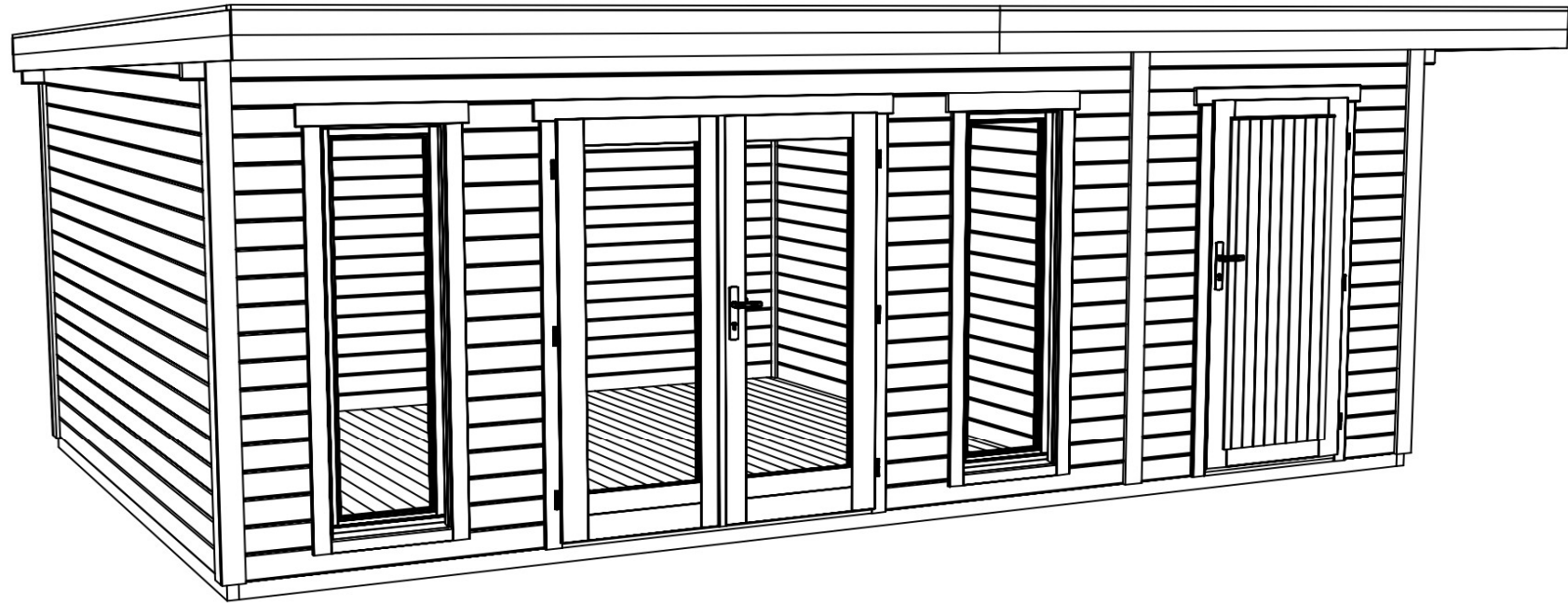

03.05.2023

Art.Nr. 4428902

Groundplan - Grundplan - Plan de masse - Planimetria - Plattegrond -
Planimetría - Põhiplaan

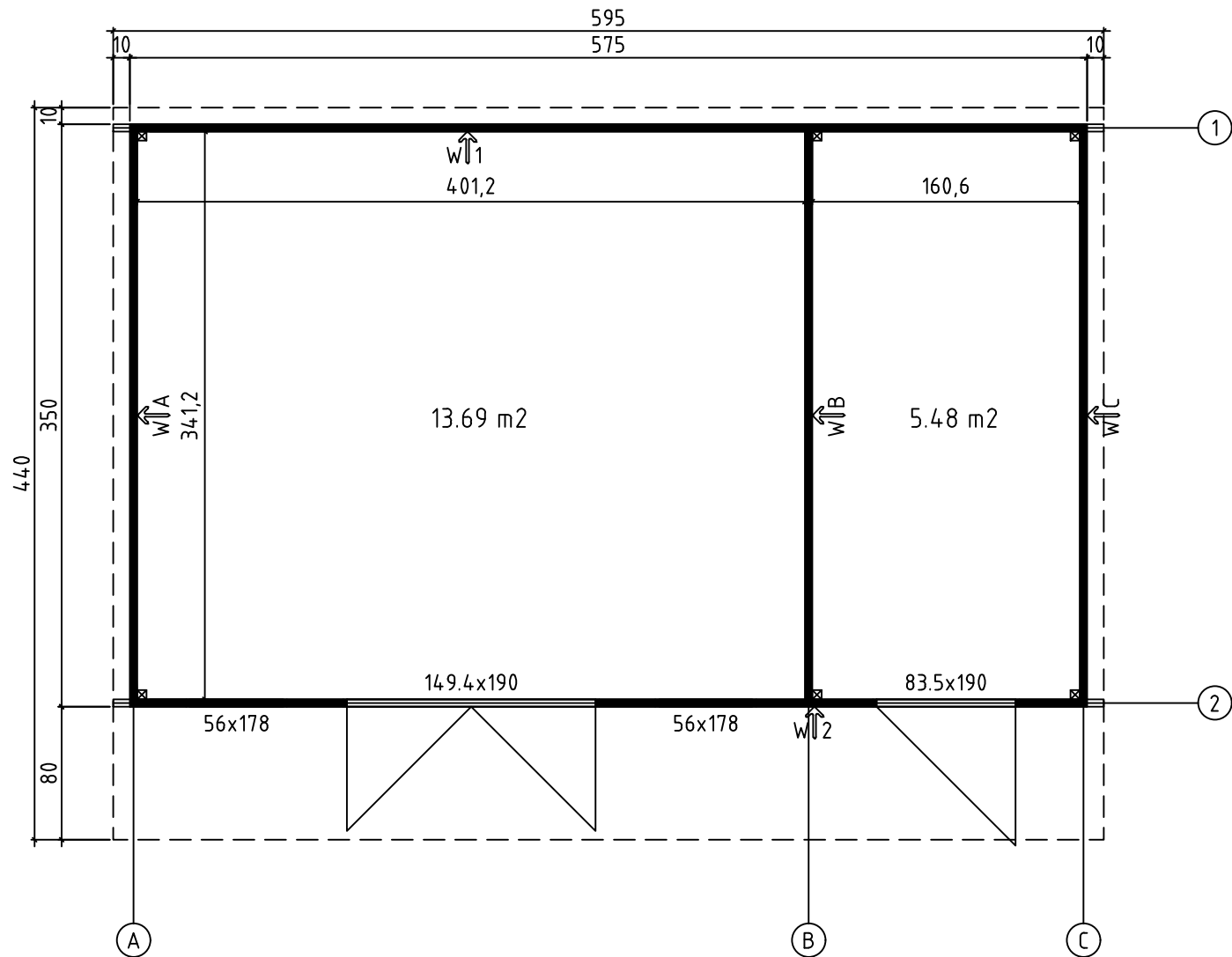

Art.Nr. 4428902

Foundation - Fundament - Fondation - Fundamenta - Fundering -
Bastidor impregnado - Immutatud alusraam

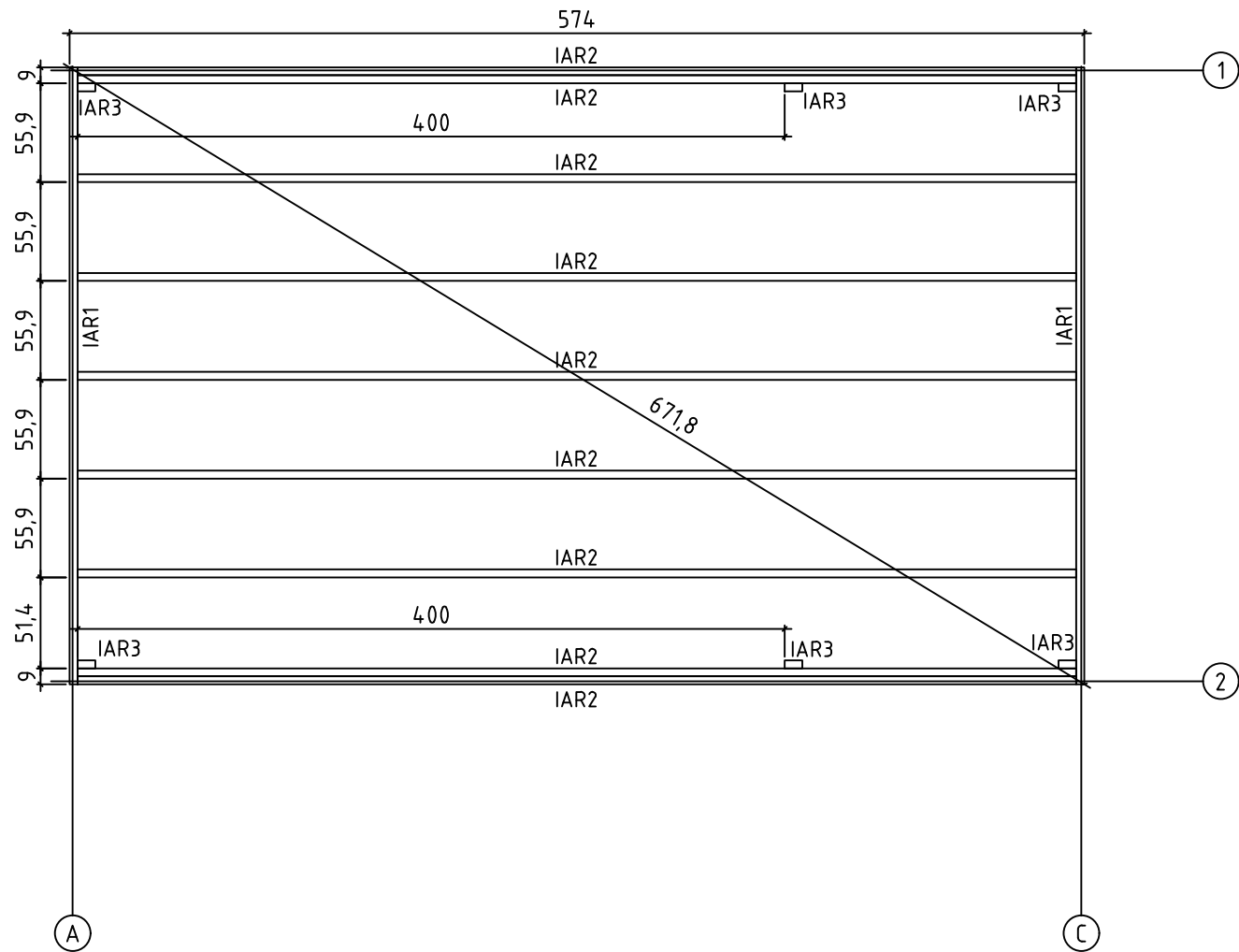

Art.Nr. 4428902



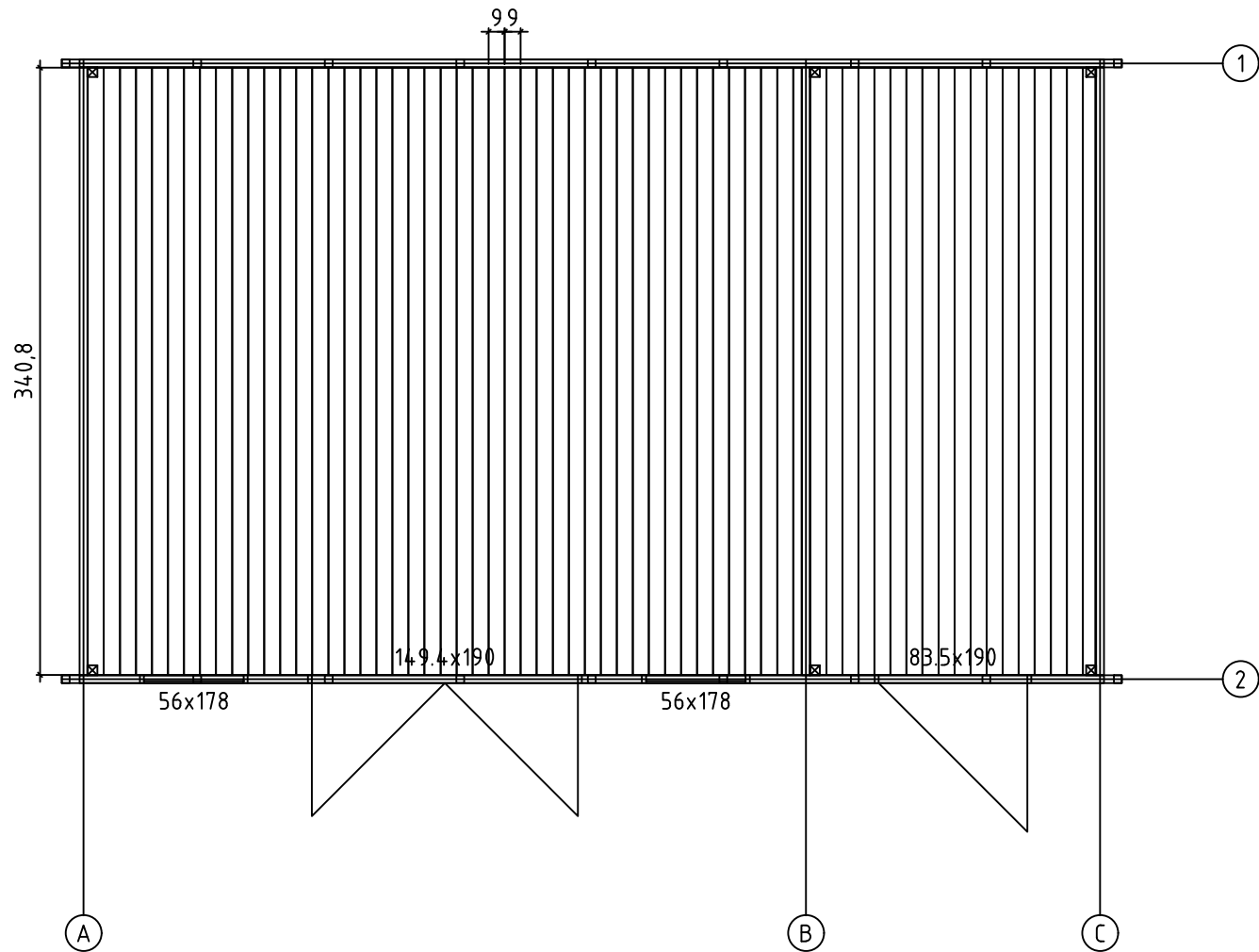

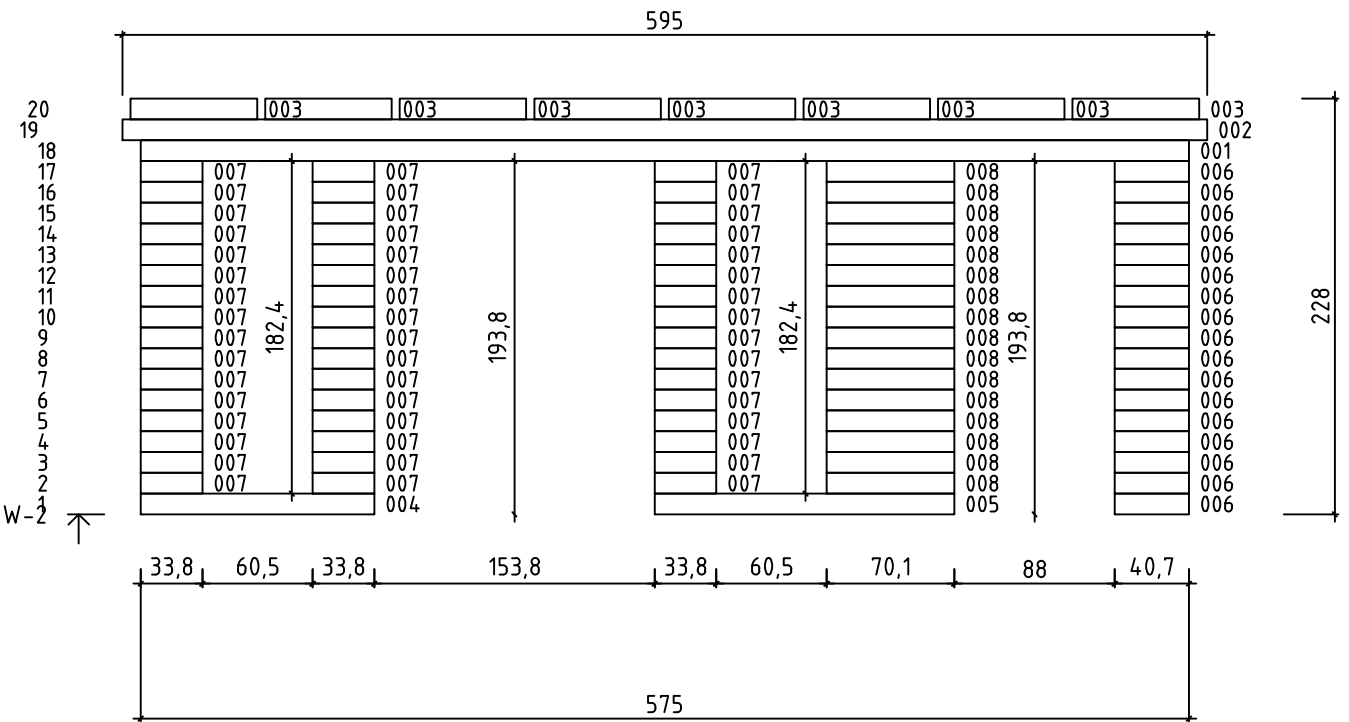
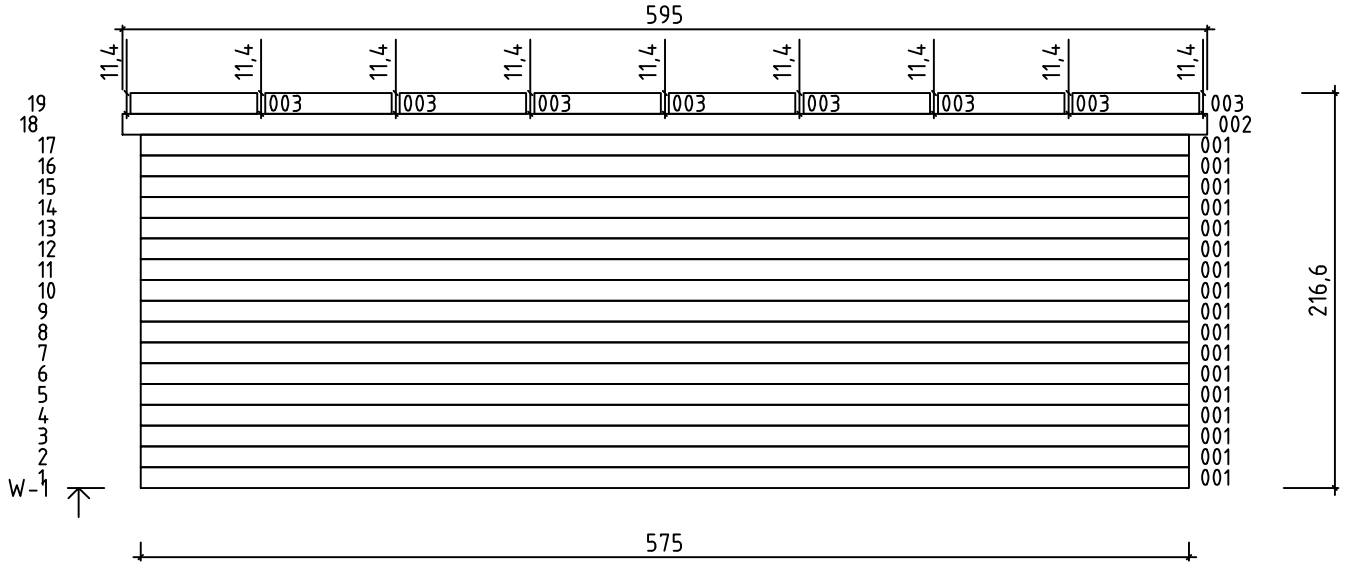

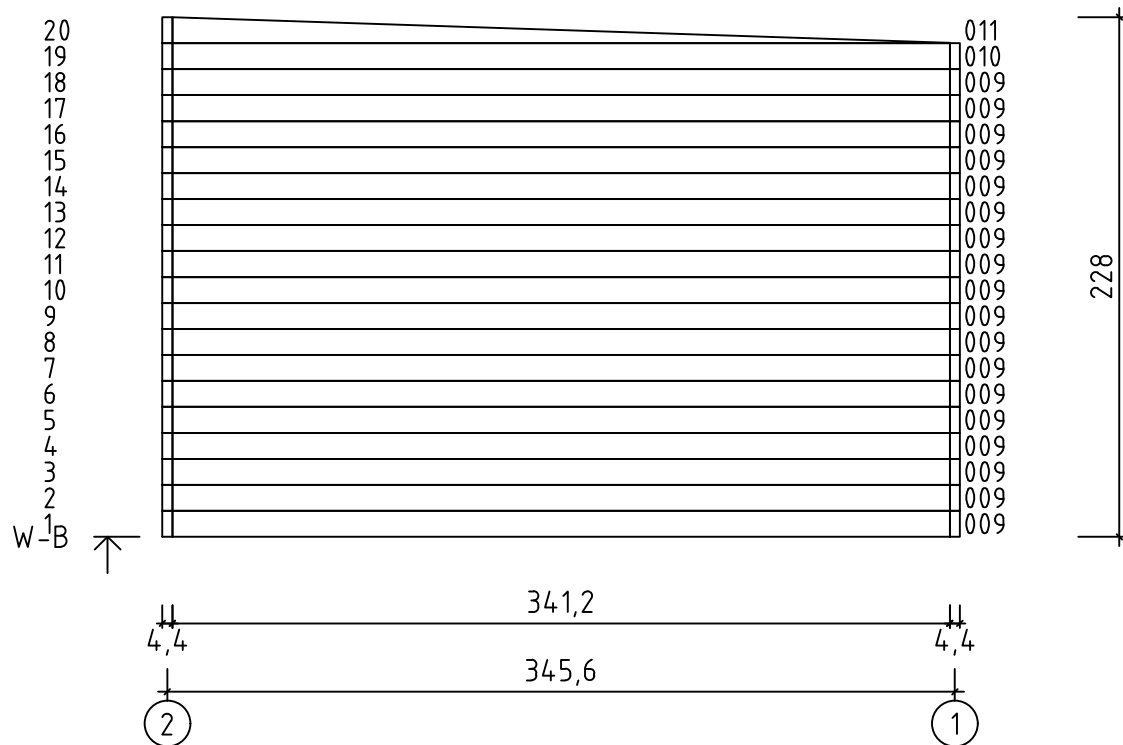
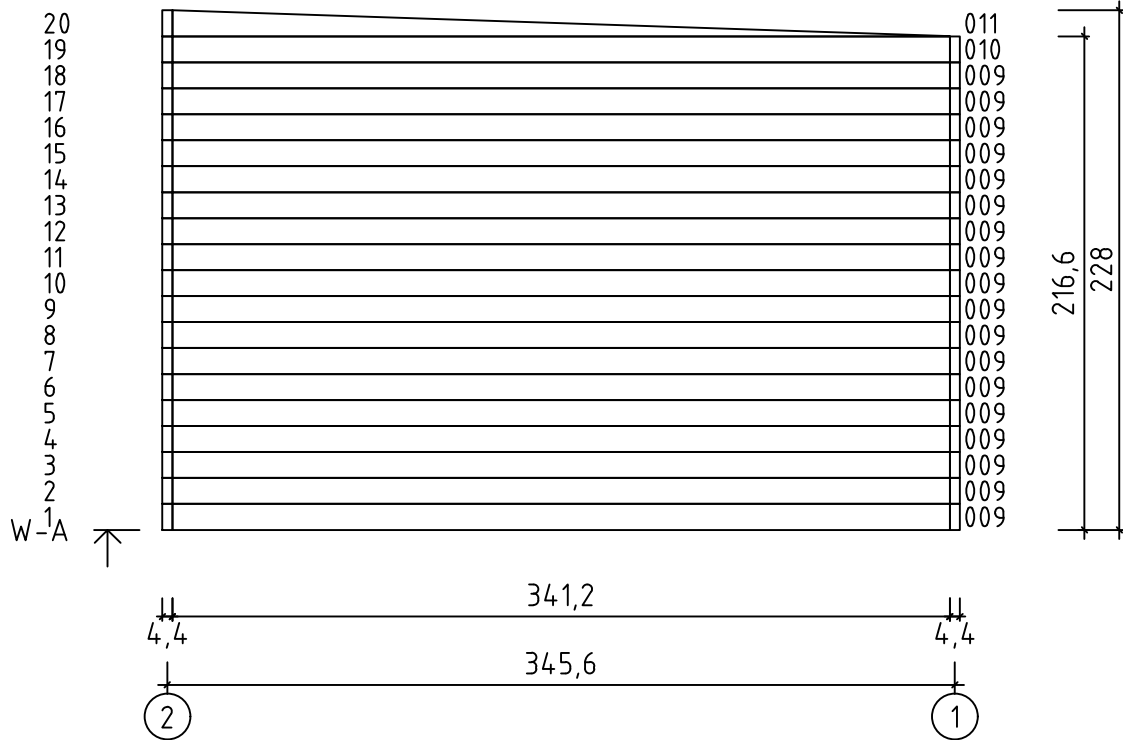

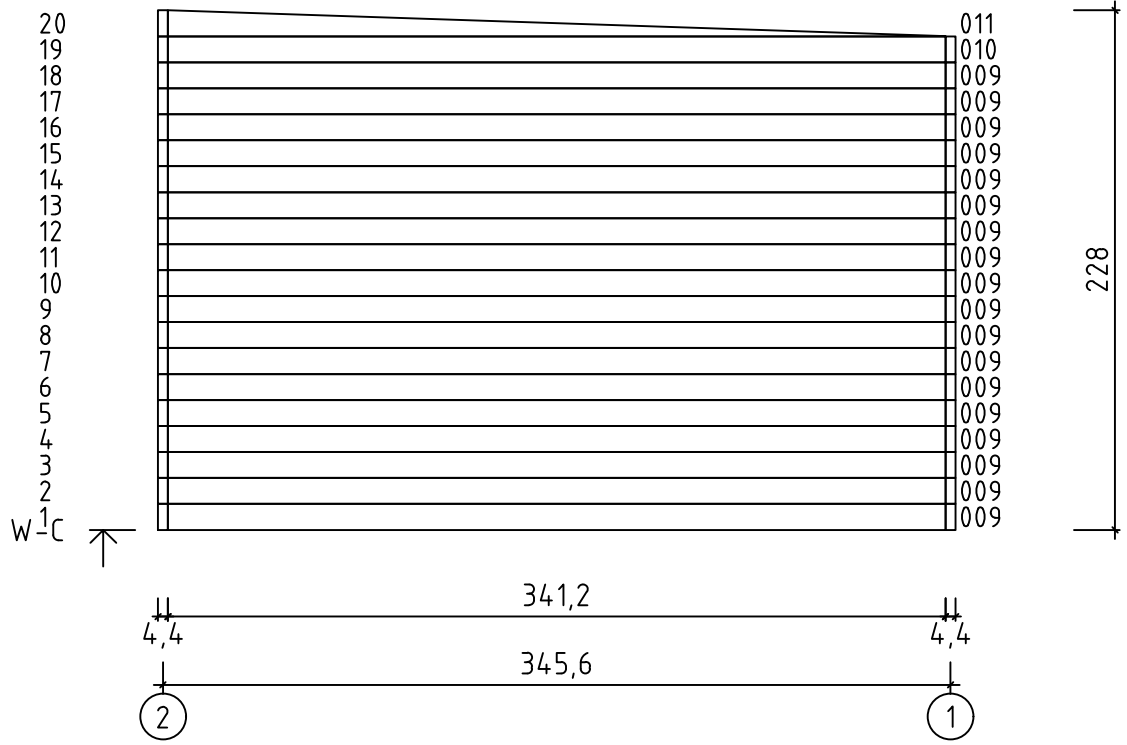

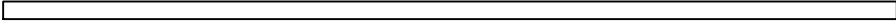
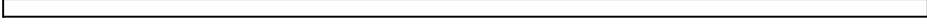

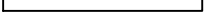
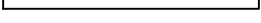

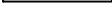
Floor boards - Fussbodenbretter - Plan pose plancher - Pavimento -
Vloerhout - Tarima de suelo - Põrandalaudis

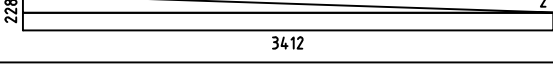
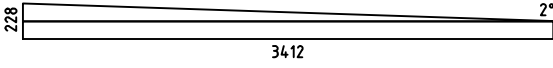
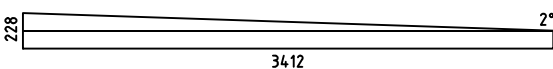
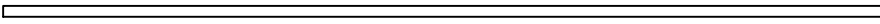
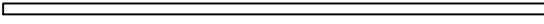









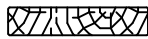
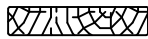
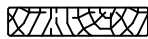
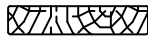
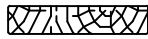
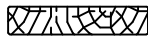

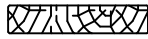





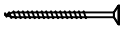

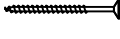
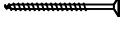
Pos	03.05.2023	Piece list - Stückliste - Liste des pièces - Elementi - Stuklijst - Elementos - Tükítabel Art.Nr. 4428902	8/20	Q	P (mm)	L (mm)
001 44190				18	44x114	5750
002 43493				2	44x114	5950
003 45899				16	44x114	694
004 45767				1	44x114	1281
005 45900				1	44x114	1645
006 45901				17	44x114	406
007 45768				48	44x114	338
008 22891				16	44x114	702
009 40159				54	44x114	3412
WA-1 45770				1		
WB-1 45770				1		
WC-1 45770				1		
IAR2 38436		Foundation - Fundament - Fondation - Fundamenta - Fundering - Bastidor impregnado - Immutatud alusraam 		9	45x70	5650
IAR1 39413		Foundation - Fundament - Fondation - Fundamenta - Fundering - Bastidor impregnado - Immutatud alusraam 		2	45x70	3490
IAR3 34041		Foundation - Fundament - Fondation - Fundamenta - Fundering - Bastidor impregnado - Immutatud alusraam 		6	45x70	100
SR1 45771		Rafter - Dachsparren - Chevron - Trave - Dak spar - Cabio - Sarikas 		9	44x140	4407
FB-1 32155		Floor boards - Fussbodenbretter - Lame de plancher - Pavimento - Vloerhout - Tablero de suelo - Põrandalaud 		63	90x18	3408
RB-1 45902		Roof boards - Dachbretter - Voliges - Perlina per tetto - Dakhout - Tablero de tejado - Katuselaud 		98	90x18	2975
FL-1 30087		Floor fillet - Fussbodenleiste - Corniere de finition du plancher - Finitura per pavimento (battisco pa) - Vloerafwerkljst - Rodapié - Põrandaliist 			18x18	25
DPL-1 32417		Roofing felt fillet - Dachpappenleiste - Baguette de fixation du feutre bitumeux - Asse per fissaggio guaina bituminosa - Afdeklijst asfaltpapier - Moldura de fieltro para tejado - Katusepapiiist 		2	18x58	2993
DPL-2 24933		Roofing felt fillet - Dachpappenleiste - Baguette de fixation du feutre bitumeux - Asse per fissaggio guaina bituminosa - Afdeklijst asfaltpapier - Moldura de fieltro para tejado - Katusepapiiist 		2	18x58	4380

Pos	03.05.2023 Piece list - Stückliste - Liste des pièces - Elementi - Stuklijst - Elementos - Tükítabel Art.Nr. 4428902 9/20	Q	P (mm)	L (mm)
TBE5-1 1883	Corner fillet - Deckleiste - Profils de finition angles a l'exterieur - Massello d'angolo - (hoek)lijst - Moldura de esquina - Nurgaliist 	1	18x58	2150
TBE5-2 43734	Corner fillet - Deckleiste - Profils de finition angles a l'exterieur - Massello d'angolo - (hoek)lijst - Moldura de esquina - Nurgaliist 	1	18x58	2260
TBE2-1 975	Corner fillet - Deckleiste - Profils de finition angles a l'exterieur - Massello d'angolo - (hoek)lijst - Moldura de esquina - Nurgaliist 	2	18x90	1938
TBE2-2 1377	Corner fillet - Deckleiste - Profils de finition angles a l'exterieur - Massello d'angolo - (hoek)lijst - Moldura de esquina - Nurgaliist 	2	18x90	2052
TBE2-3 7543	Corner fillet - Deckleiste - Profils de finition angles a l'exterieur - Massello d'angolo - (hoek)lijst - Moldura de esquina - Nurgaliist 	3	18x90	2166
TBE2-4 30191	Corner fillet - Deckleiste - Profils de finition angles a l'exterieur - Massello d'angolo - (hoek)lijst - Moldura de esquina - Nurgaliist 	3	18x90	2280
P-1 45773	Post - Pfosten - Poteau - Piede registrabile - Stijl - Poste - Post 	3	55x55	2166
P-2 44805	Post - Pfosten - Poteau - Piede registrabile - Stijl - Poste - Post 	3	55x55	2280
TB-1 2127	Fascia board - Traufbrett - Bandeau de toit - Finitura lati tetto - Gevellijst - Tablero de alero  - Räästalaud	8	18x90	2993
TB-2 45774	Fascia board - Traufbrett - Bandeau de toit - Finitura lati tetto - Gevellijst - Tablero de alero  - Räästalaud	4	18x90	4405
TBE4-1 24897	Fixing fillet - Fixierungsleiste - Profil de fixation - Massello di fissaggio - Bevestiging lijstwerk - Moldura en T - Tenderliist 	4	18x44	1800
TBE4-2 43334	Fixing fillet - Fixierungsleiste - Profil de fixation - Massello di fissaggio - Bevestiging lijstwerk - Moldura en T - Tenderliist 	4	18x44	1910
HS12 5109	Screw for corner batten - Schrauben für deckleisten - Vis de fixation profils de finition angles a l'exterieur - Viti per stecca d'angolo - Schroef voor afdeklát - Tornillo para moldura de esquina - Kruvi nurgaliistule 	120	4x40	
HS12 5109	Screw for fascia boards - Schrauben für traufbretter - Vis pour fixation bandeau de toit - Viti x striscia del tetto - Schroef voor gevellijst - Tornillo para tablero de alero - Kruvi räästalauale 	120	4x40	
HS12 5109	Screw for fixing fillet of door and window - Schrauben für fixierungsleiste - Vis pour profil vertical de fixation pour ouvertures des fenetres et portes - Viti per massello di fissaggio - Schroeven voor bevestiging van deur en raam lijsten - Tornillo para molduras en T - Kruvi tenderliistule 	50	4x40	
HS34 40958	Screw for rafter - Schrauben für dachsparren - Vis pour chevron - Vite per trave - Schroef voor dakspar - Tornillo para cabio - Kruvi sarikale 	10	5x80	
HS34 40958	Screw for wall details - Schraube für wand details - Vis pour mur details - Viti per elementi della porta - Schroef voor wand details - Tornillo para elementos de pared - Kruvi seinadetailidele 	400	5x80	
HS16 5115	Screw for foundation - Schrauben zur befestigung fundament - Vis de fixations des poutrelles de fondations - Viti x fundamenta - Schroef voor fundering - Tornillo para bastidor - Kruvi alusraamile 	30	5x90	
HS22 5120	Screw for 1. wall beam - Schraube für 1. bohlenreihe - Vis de fixations 1ere rangée de madriers avec poutrelles de fondations - Vite fissaggio alle fundamenta - Schroef voor 1 wandbalk - Tornillo para medio tablero - Kruvi poollauale 	20	6x150	
HS22 5120	Screw for rafter - Schrauben für dachsparren - Vis pour chevron - Vite per trave - Schroef voor dakspar - Tornillo para cabio - Kruvi sarikatele 	20	6x150	
HS23 5121	Screw for wall details - Schraube für wand details - Vis pour mur details - Viti per elementi della porta - Schroef voor wand details - Tornillo para elementos de pared - Kruvi seinadetailidele 	260	6x180	

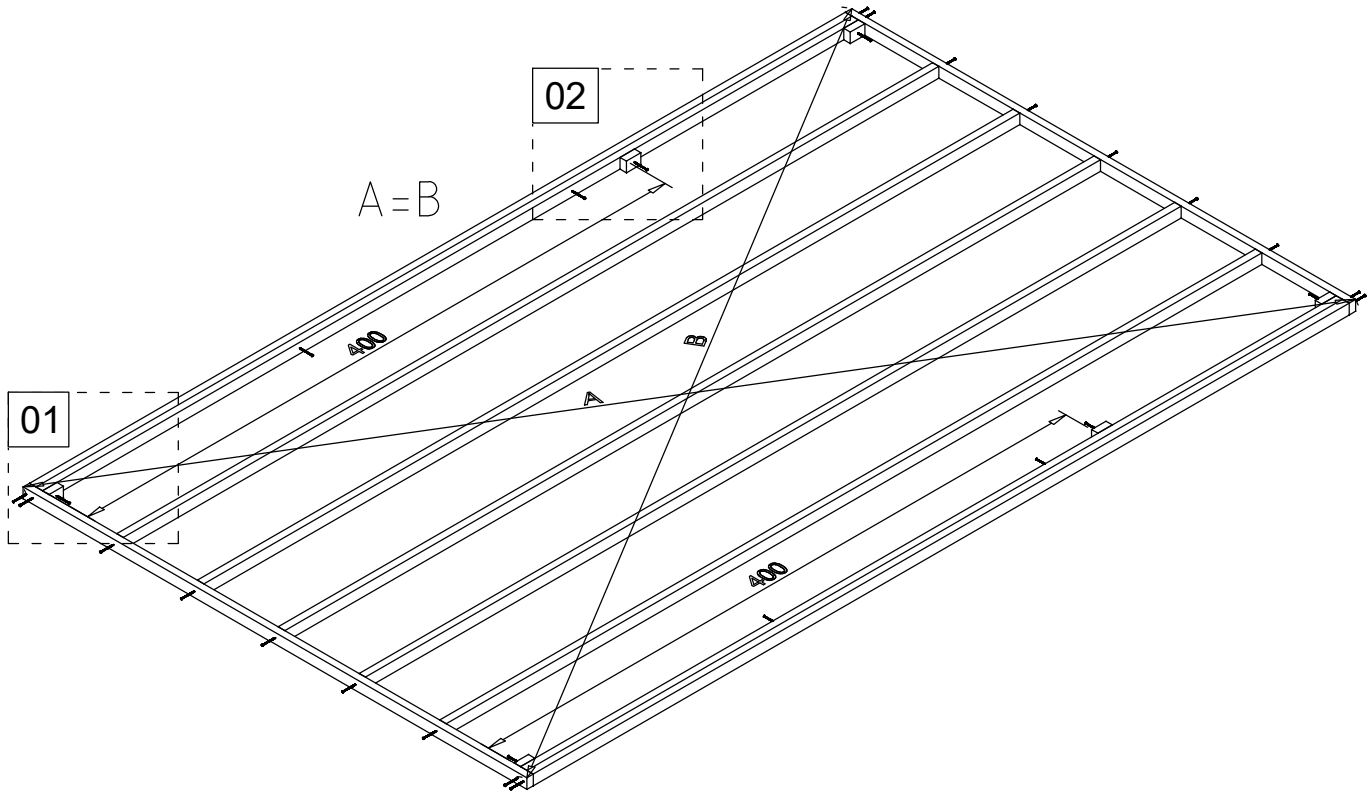

01

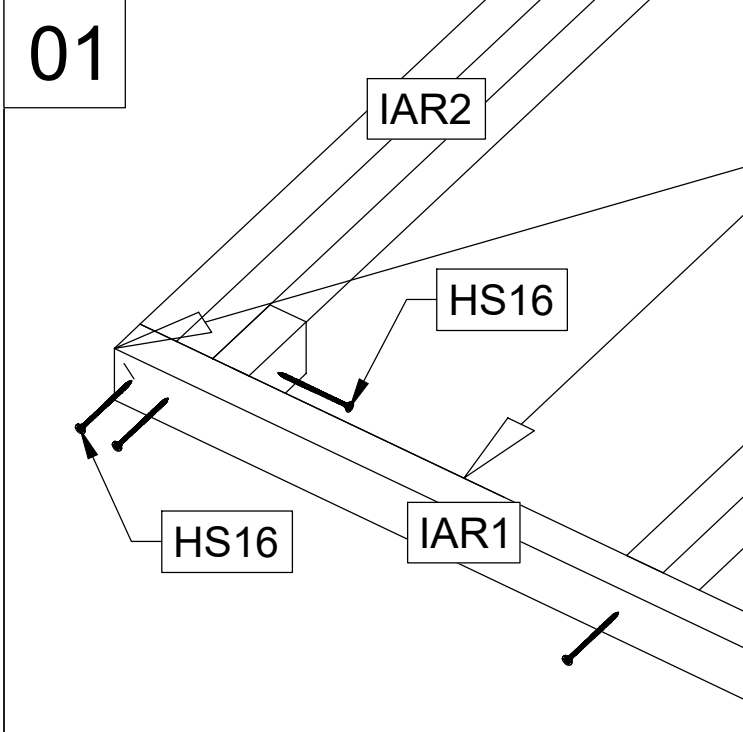

02

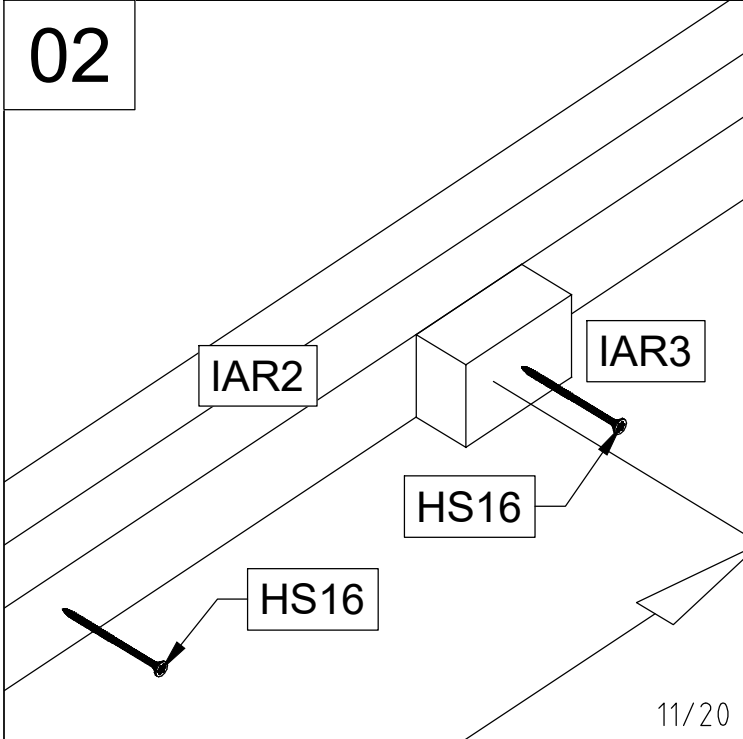

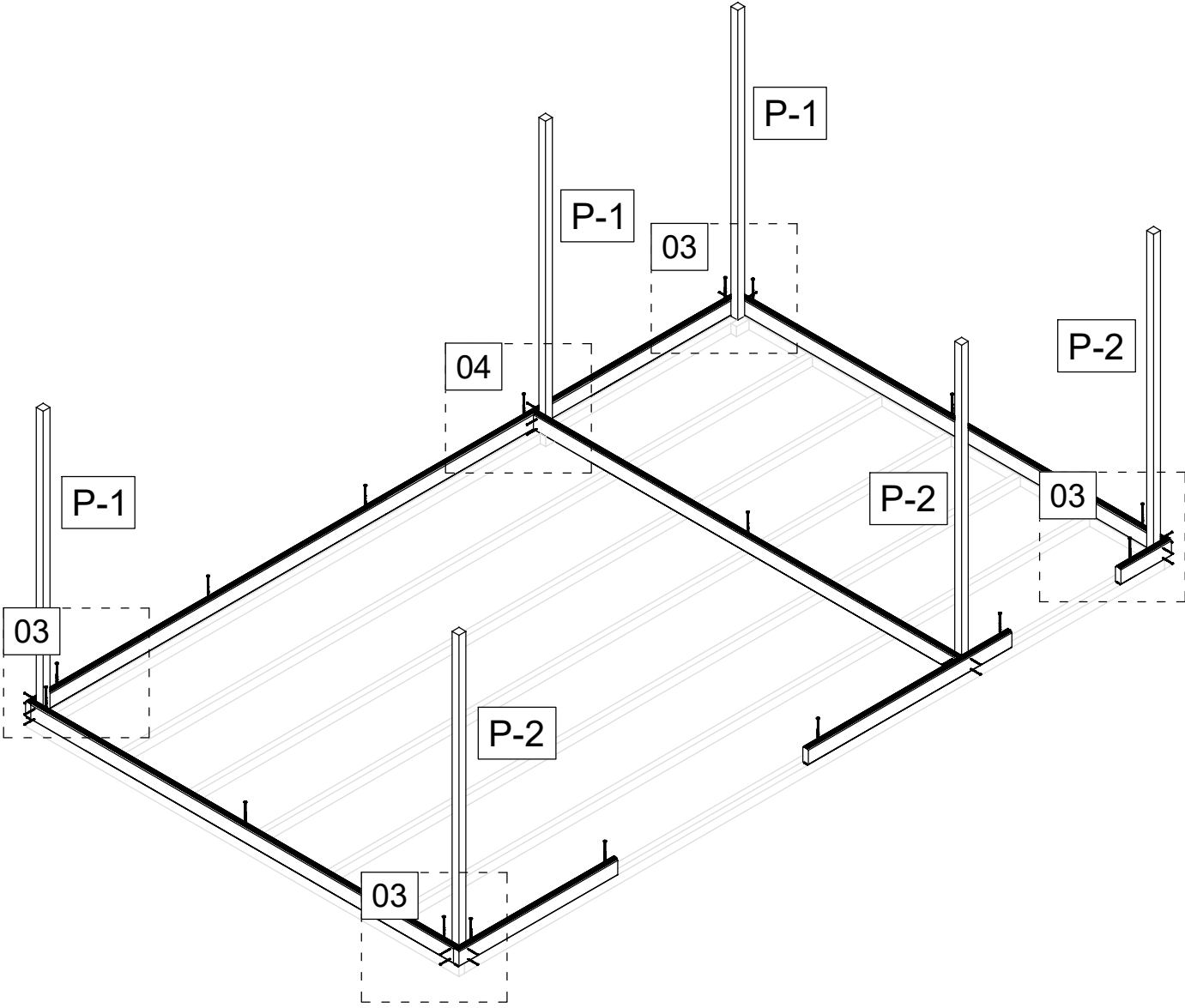

03a

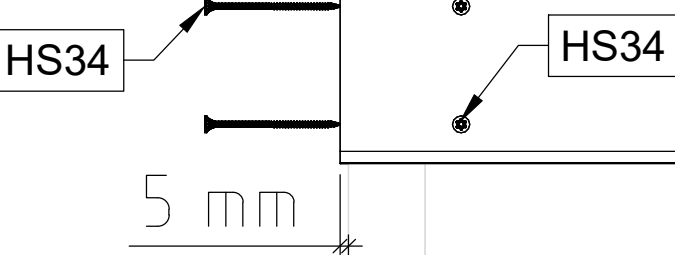

03b

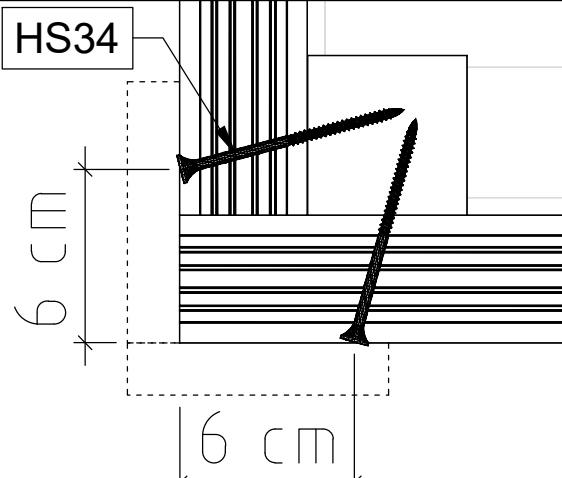

04

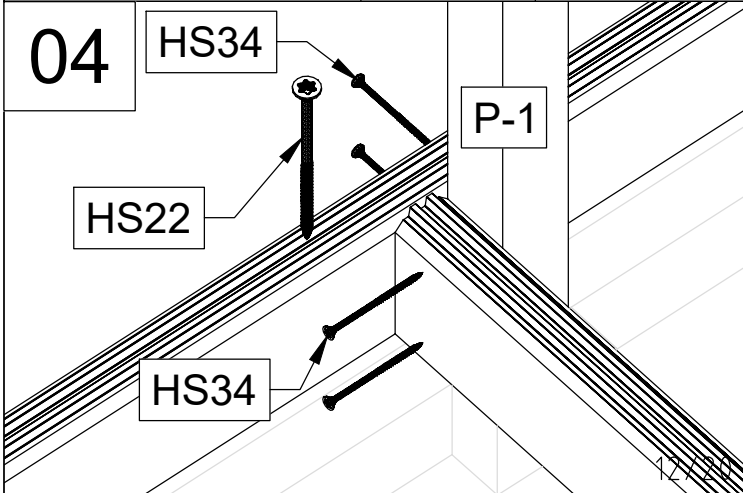

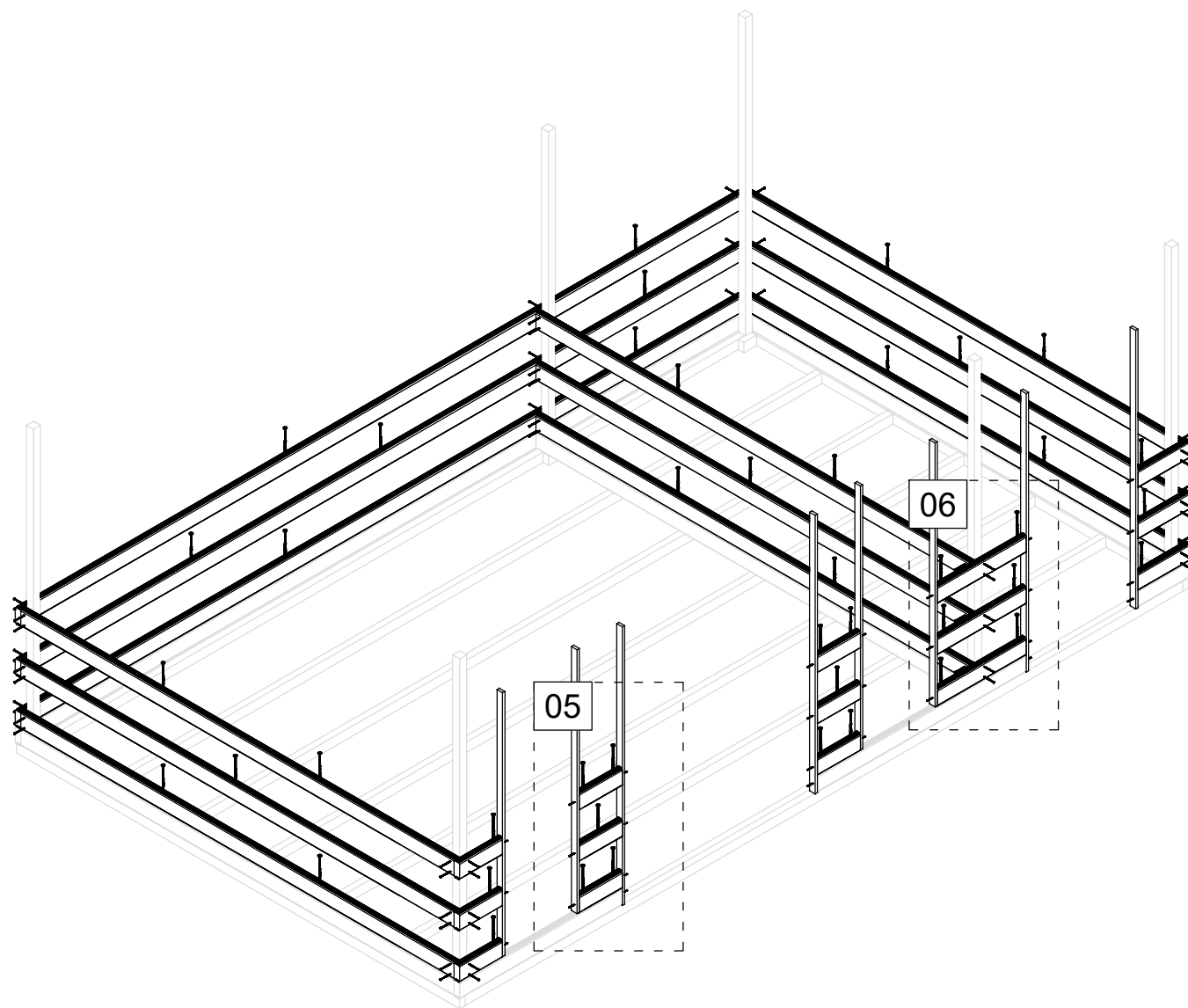

05

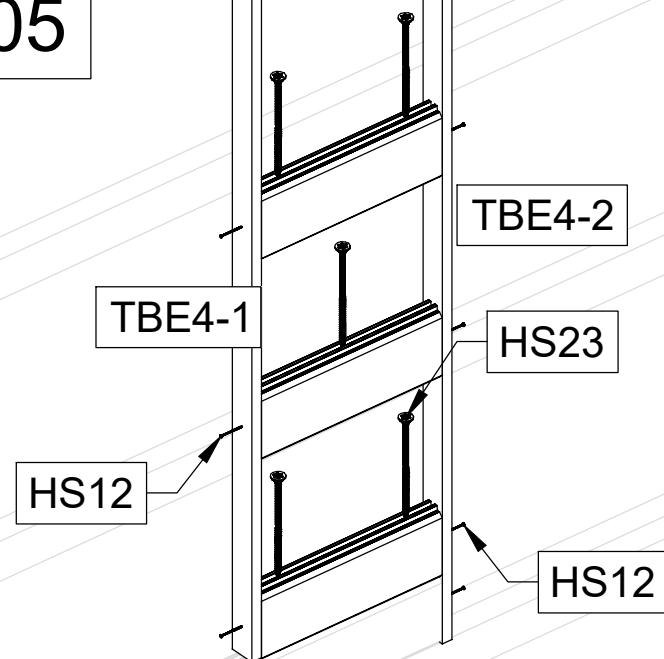

06

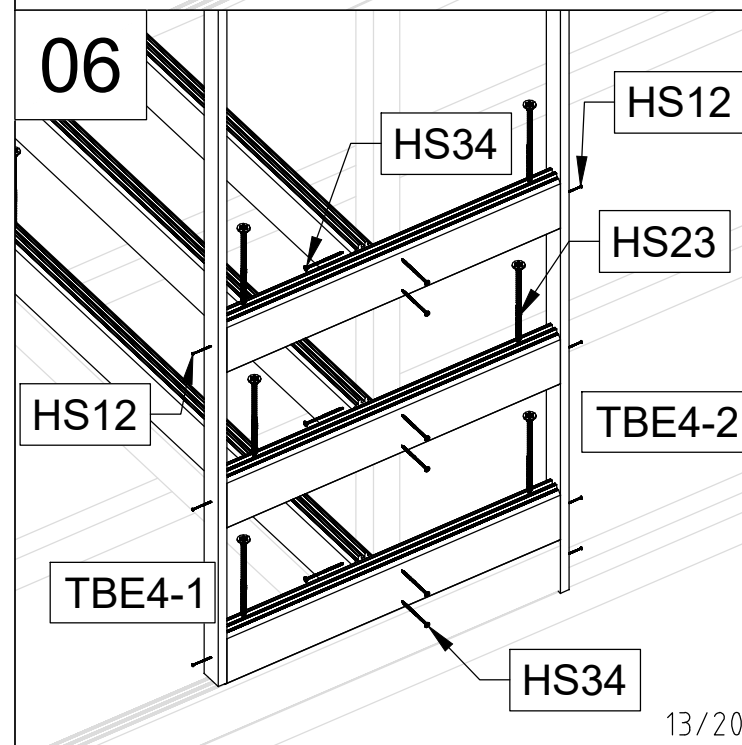

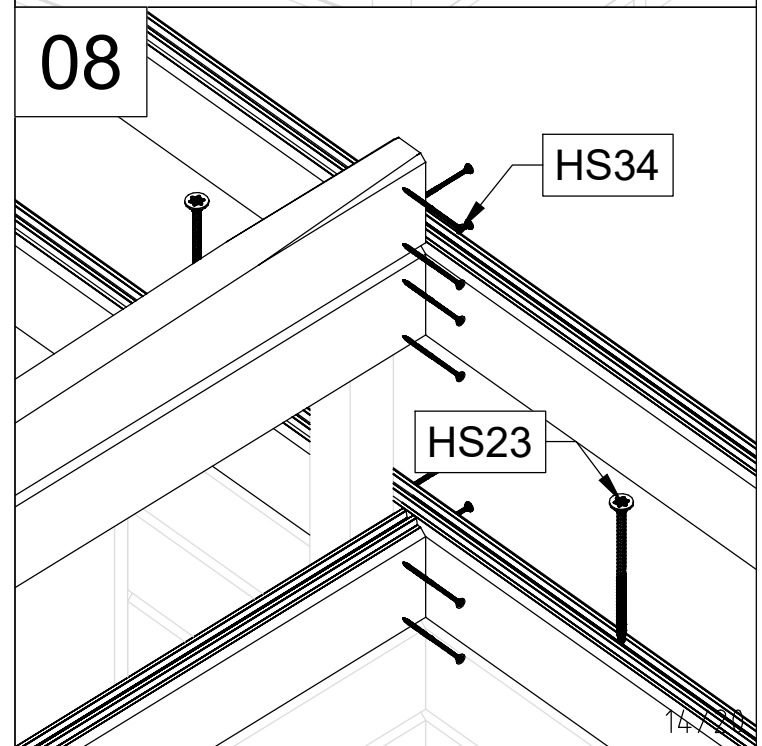
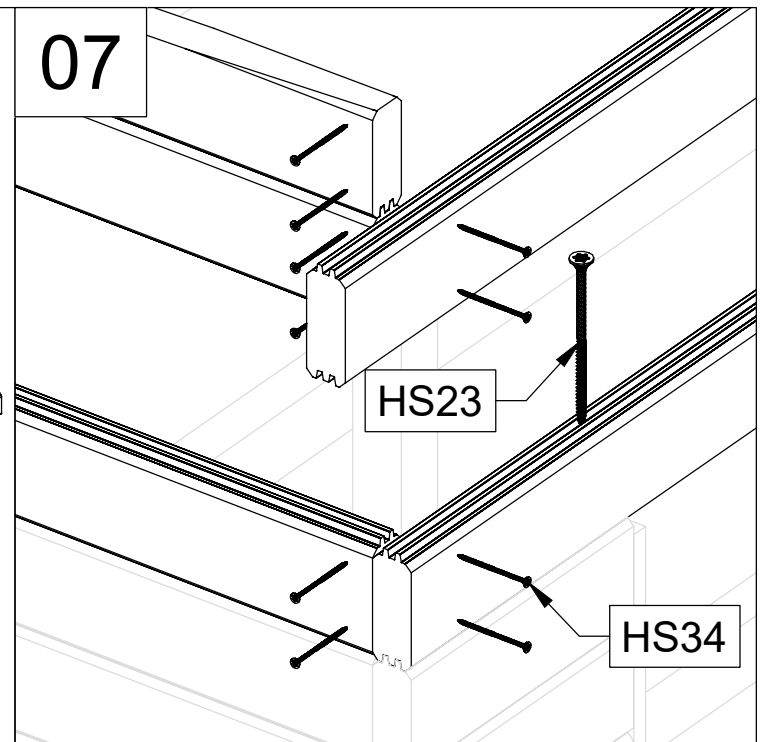
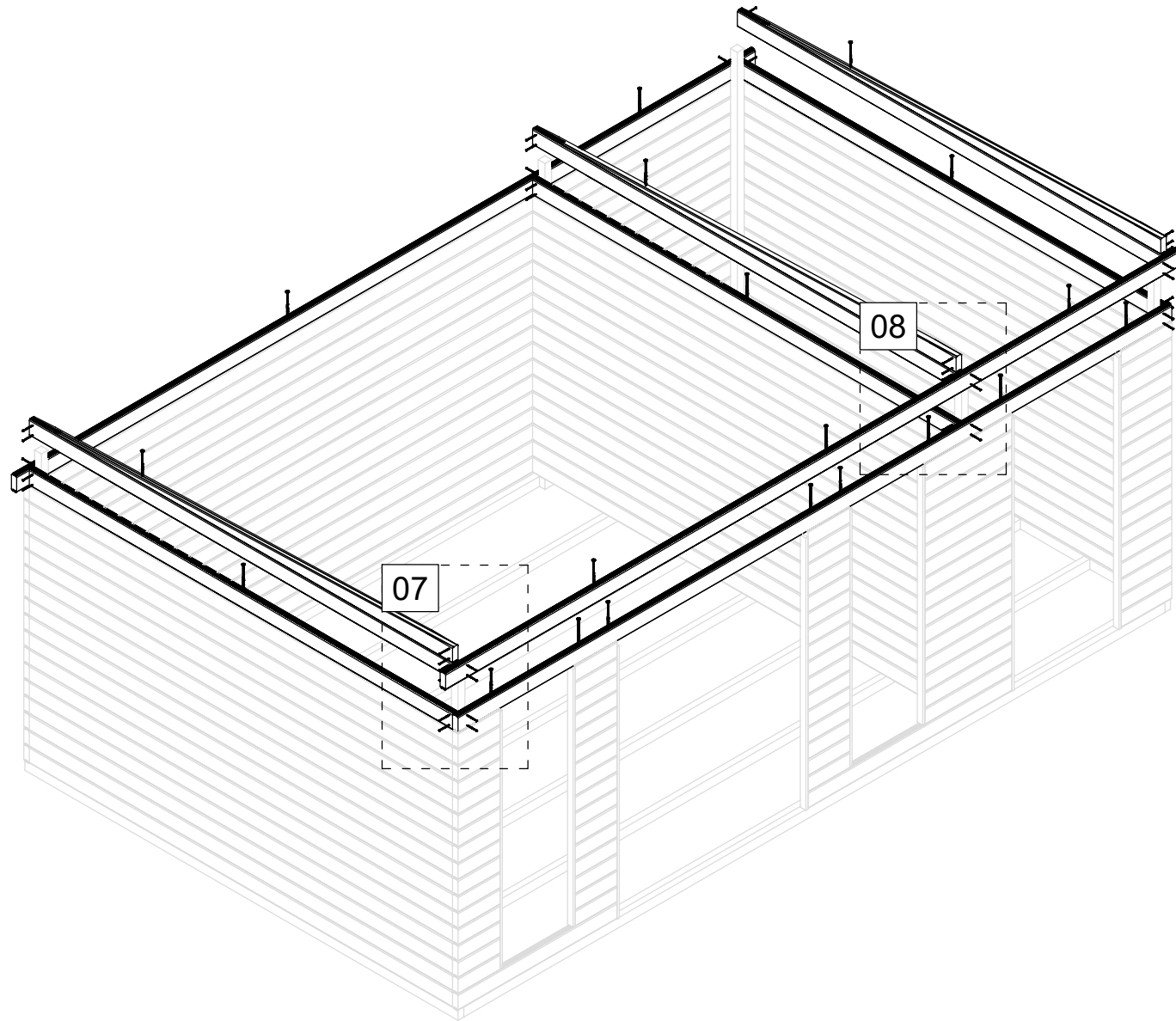

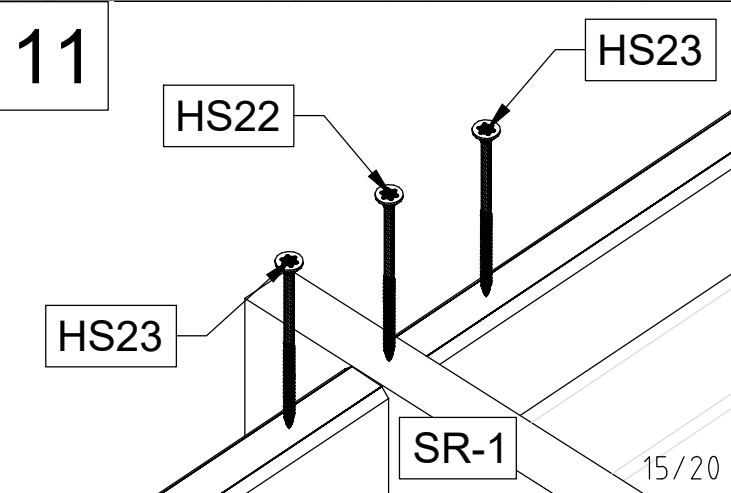
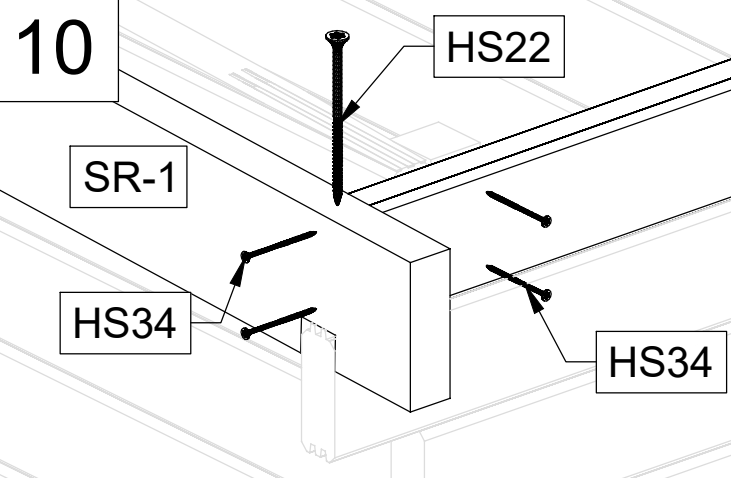
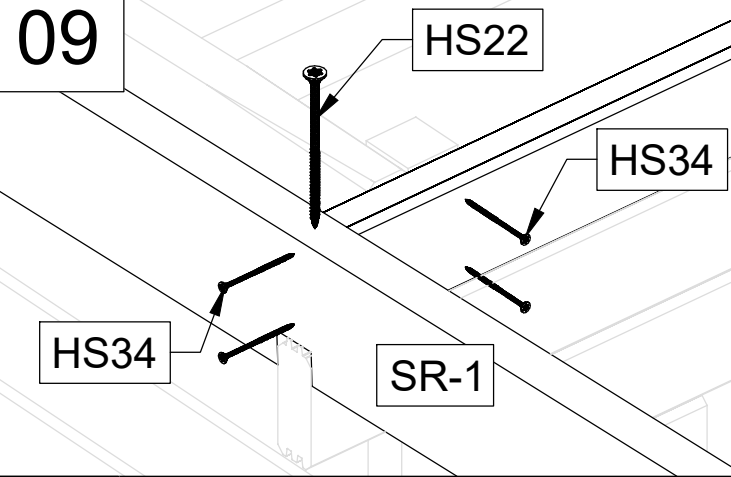
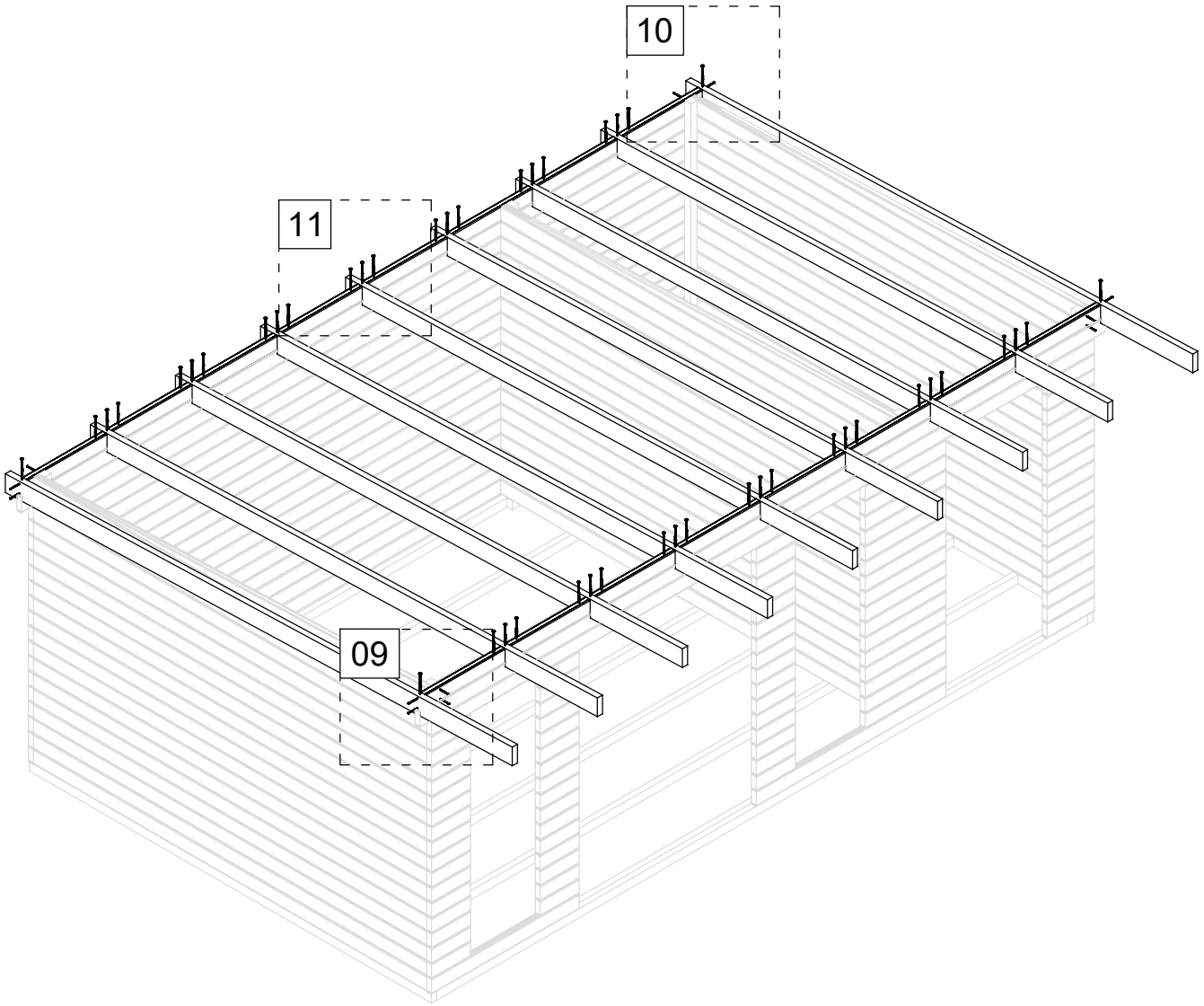

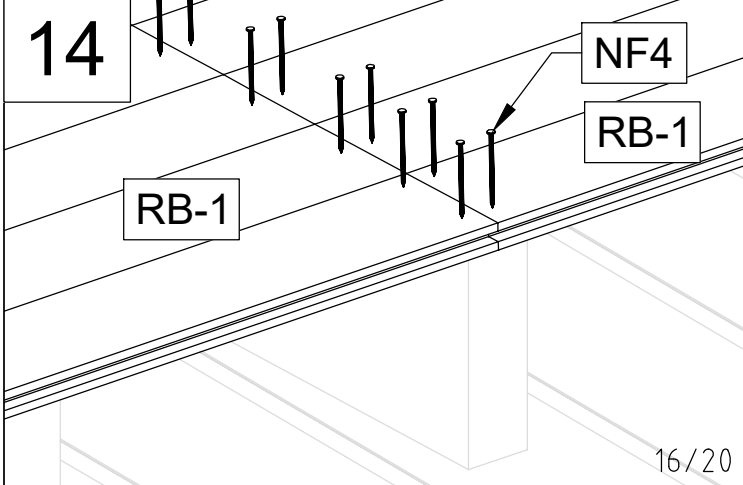
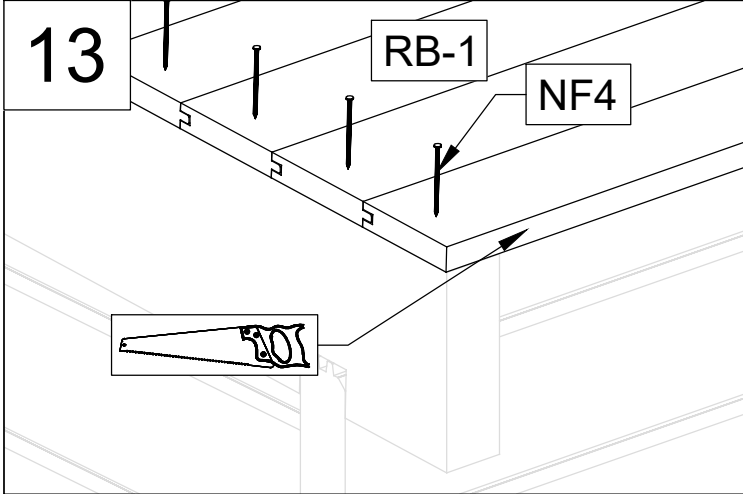
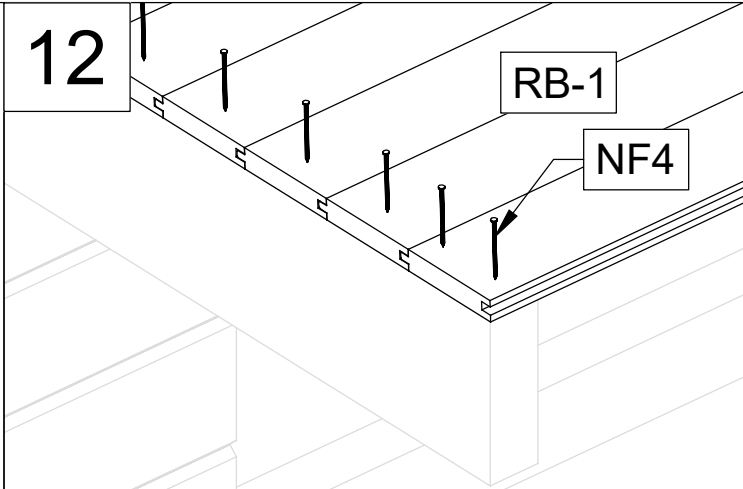
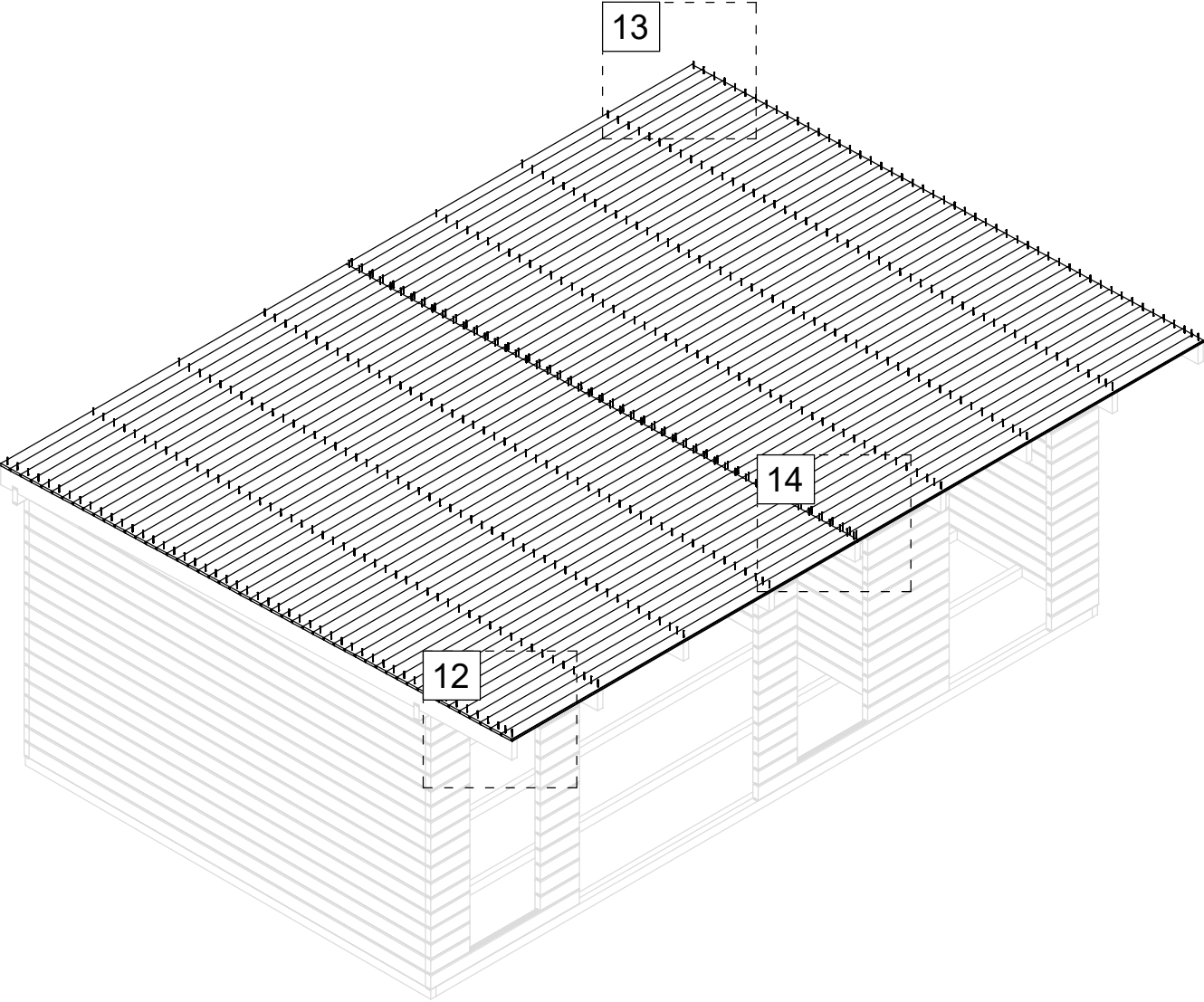

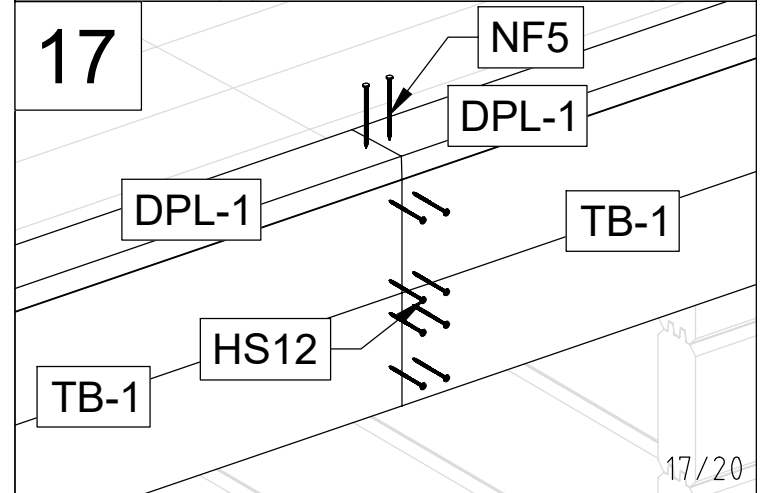
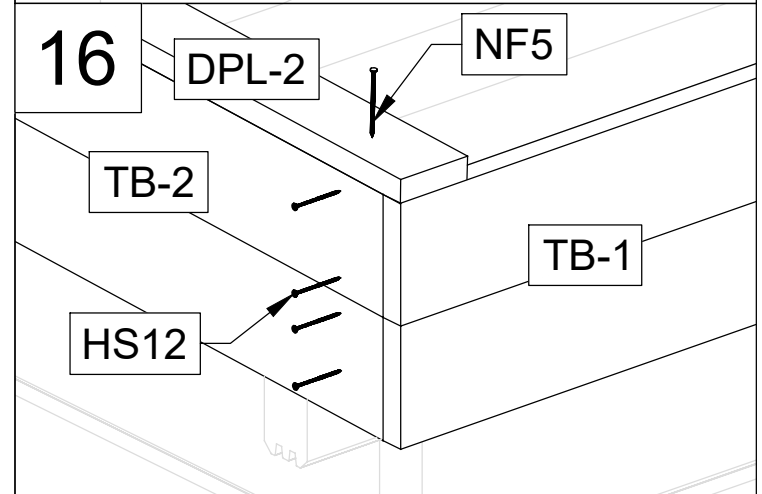
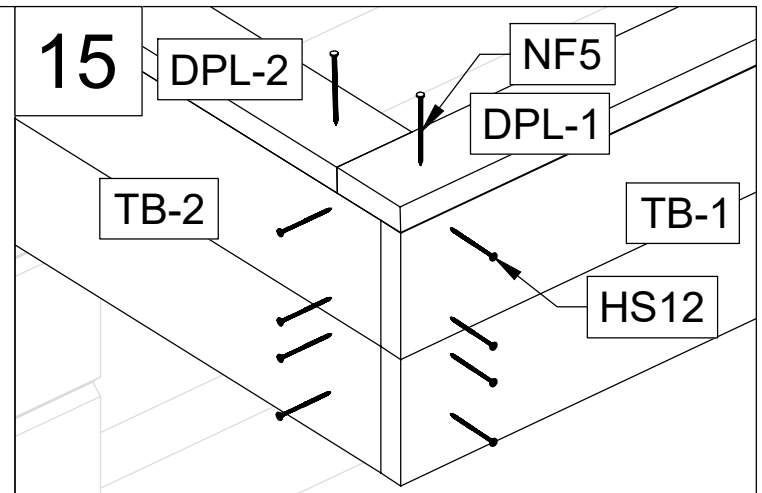
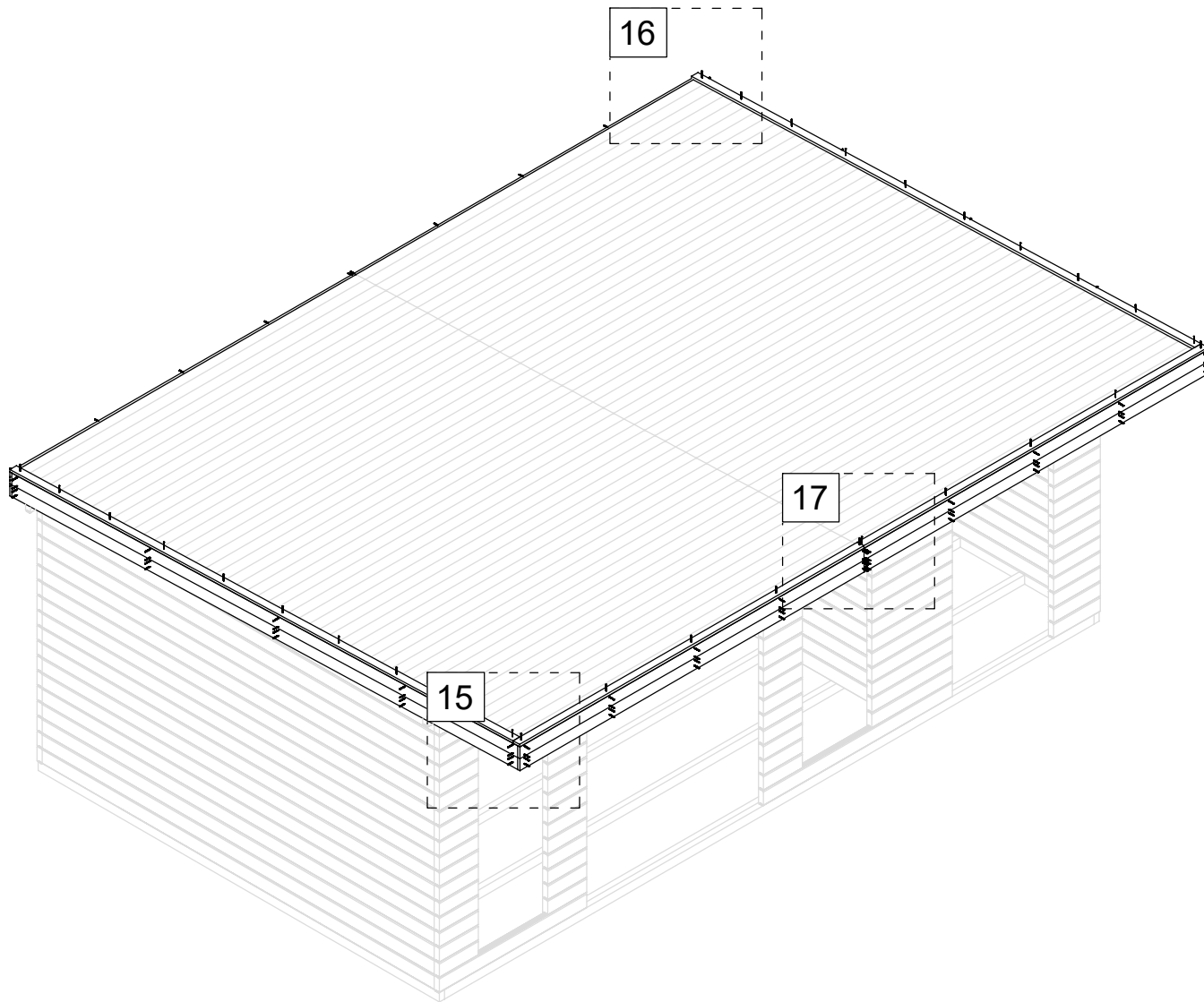

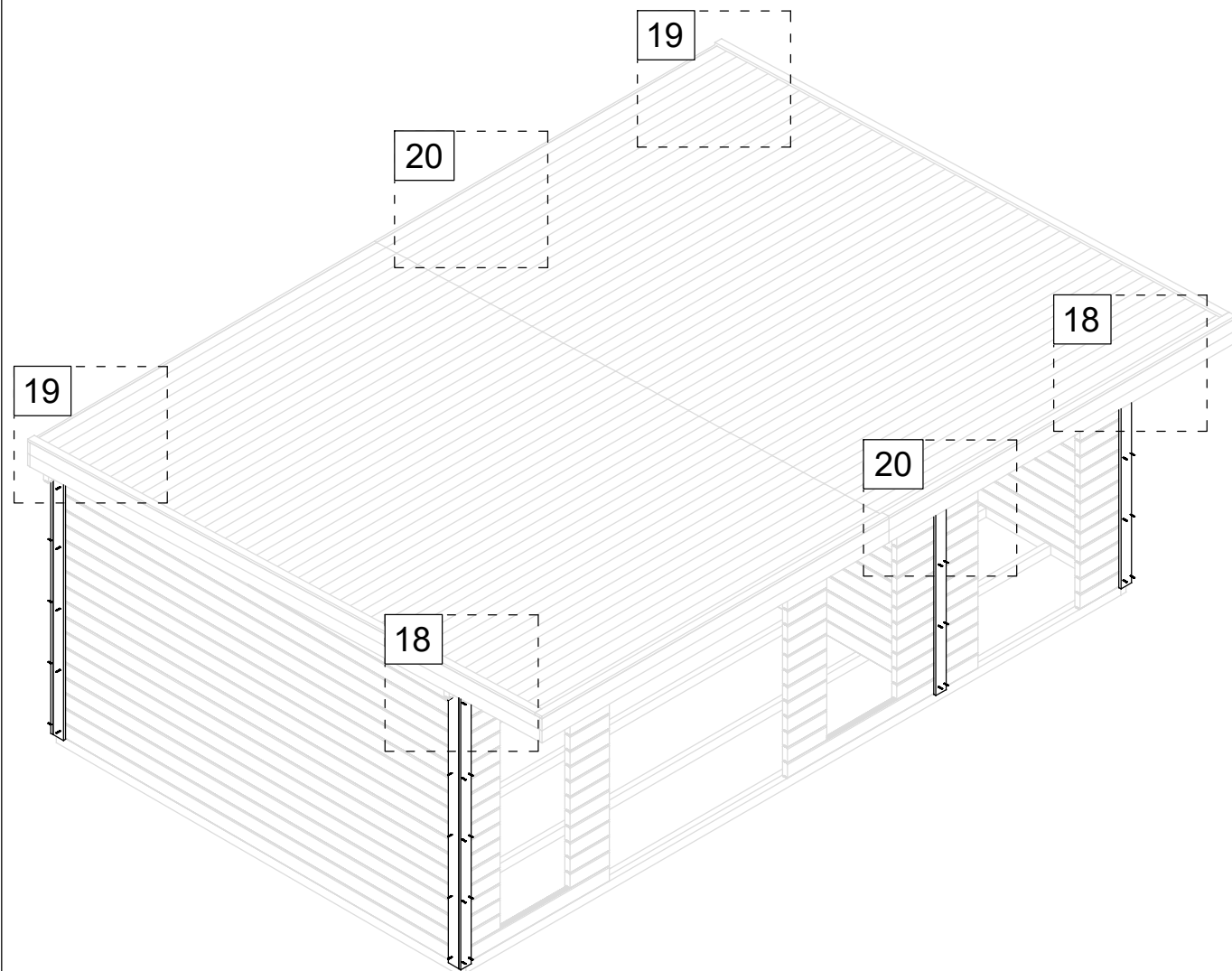

18

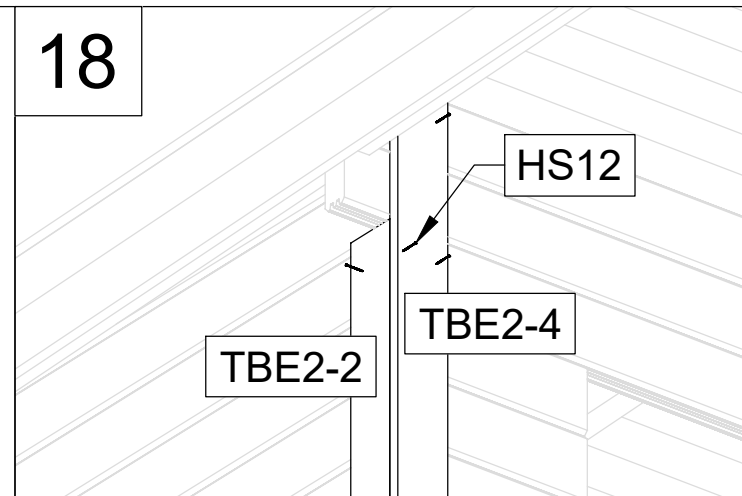

19

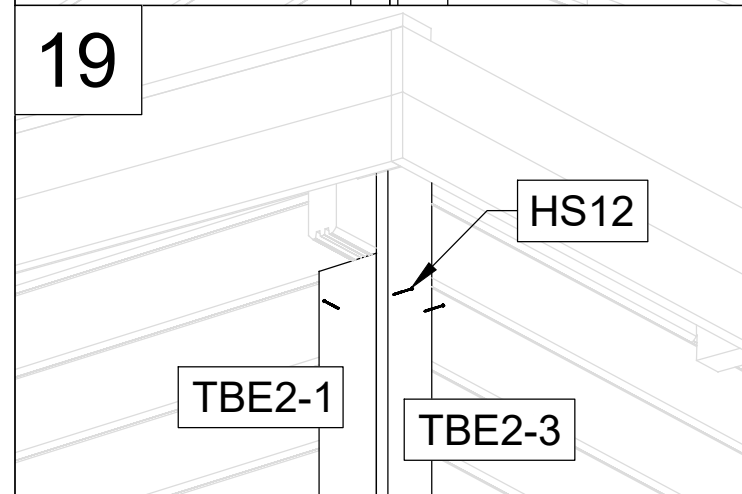

20

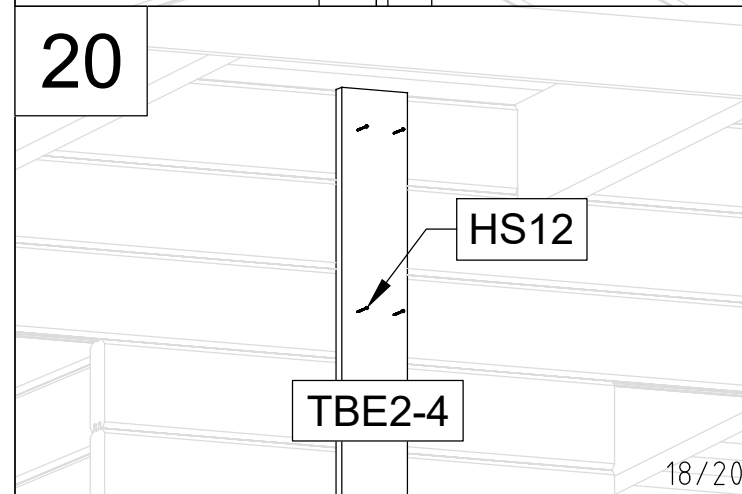

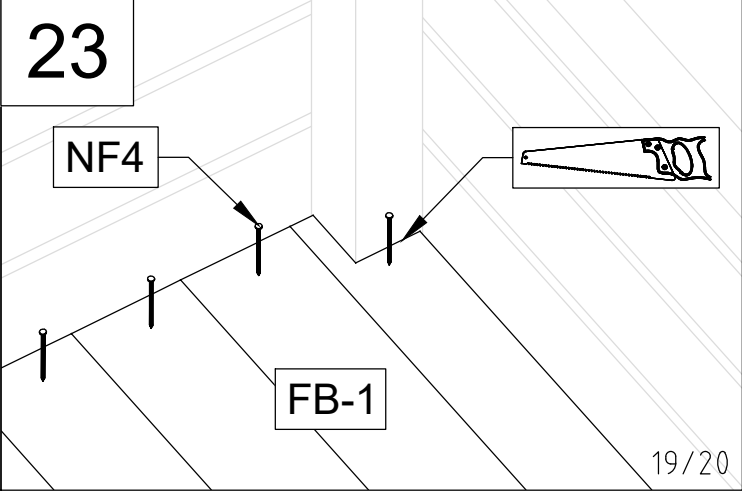
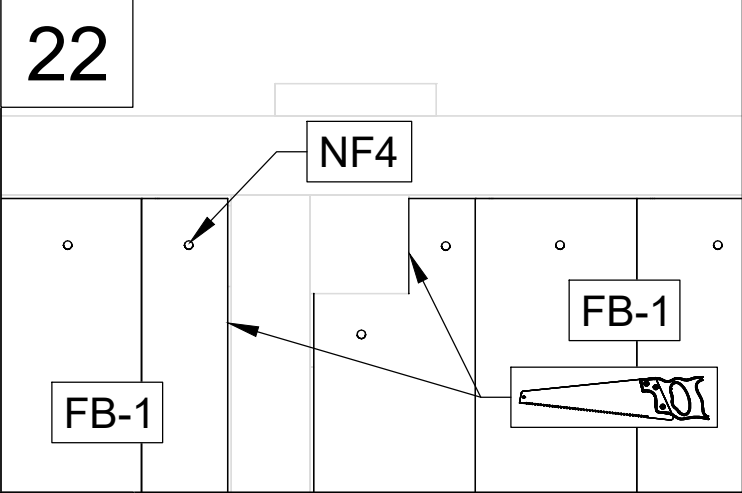
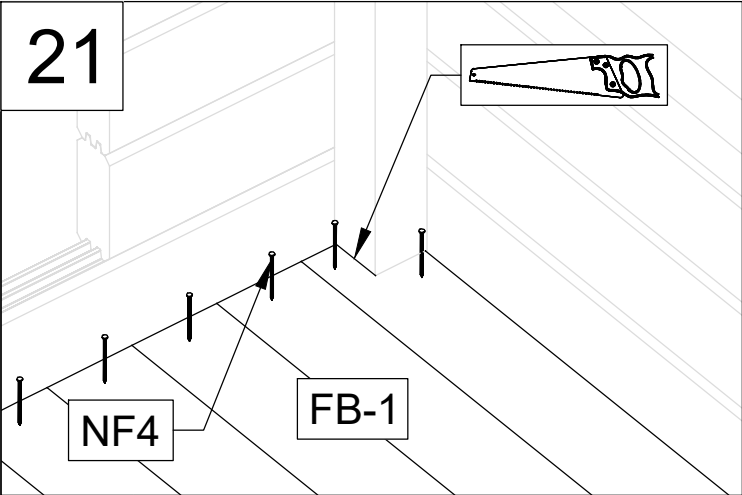
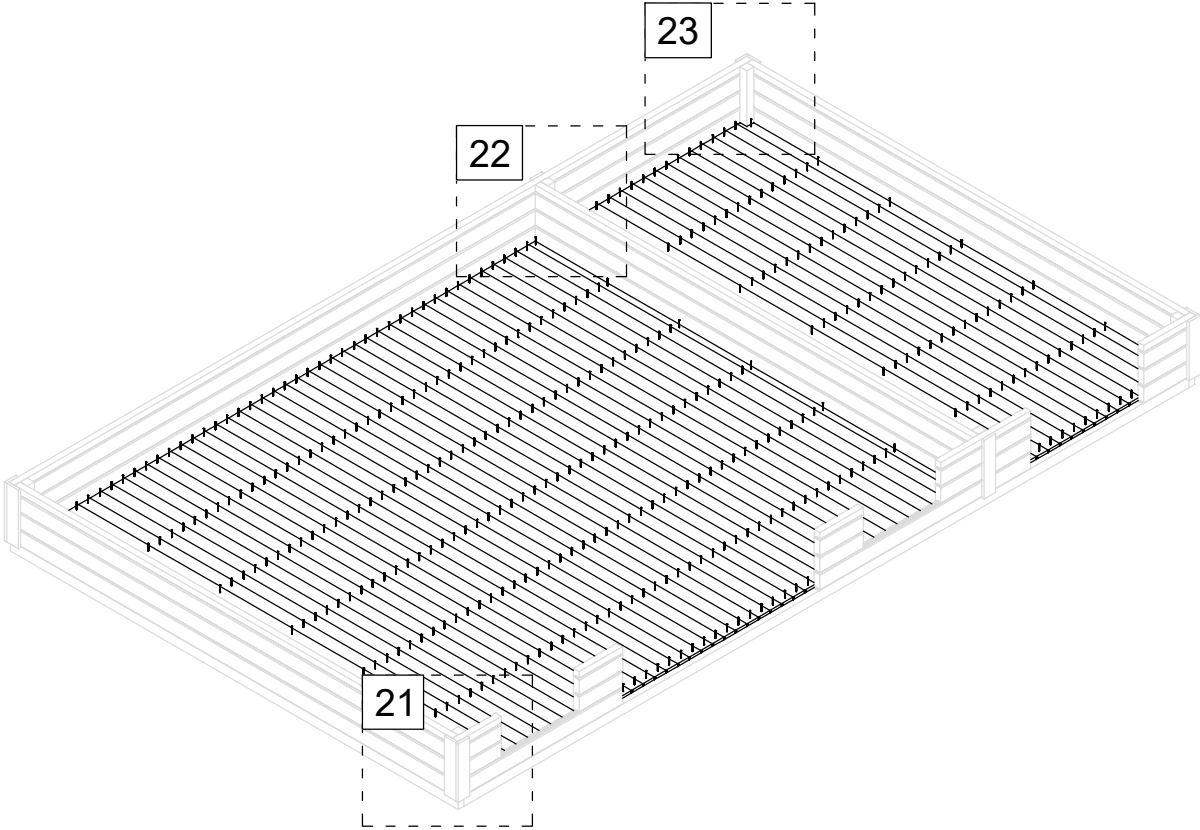

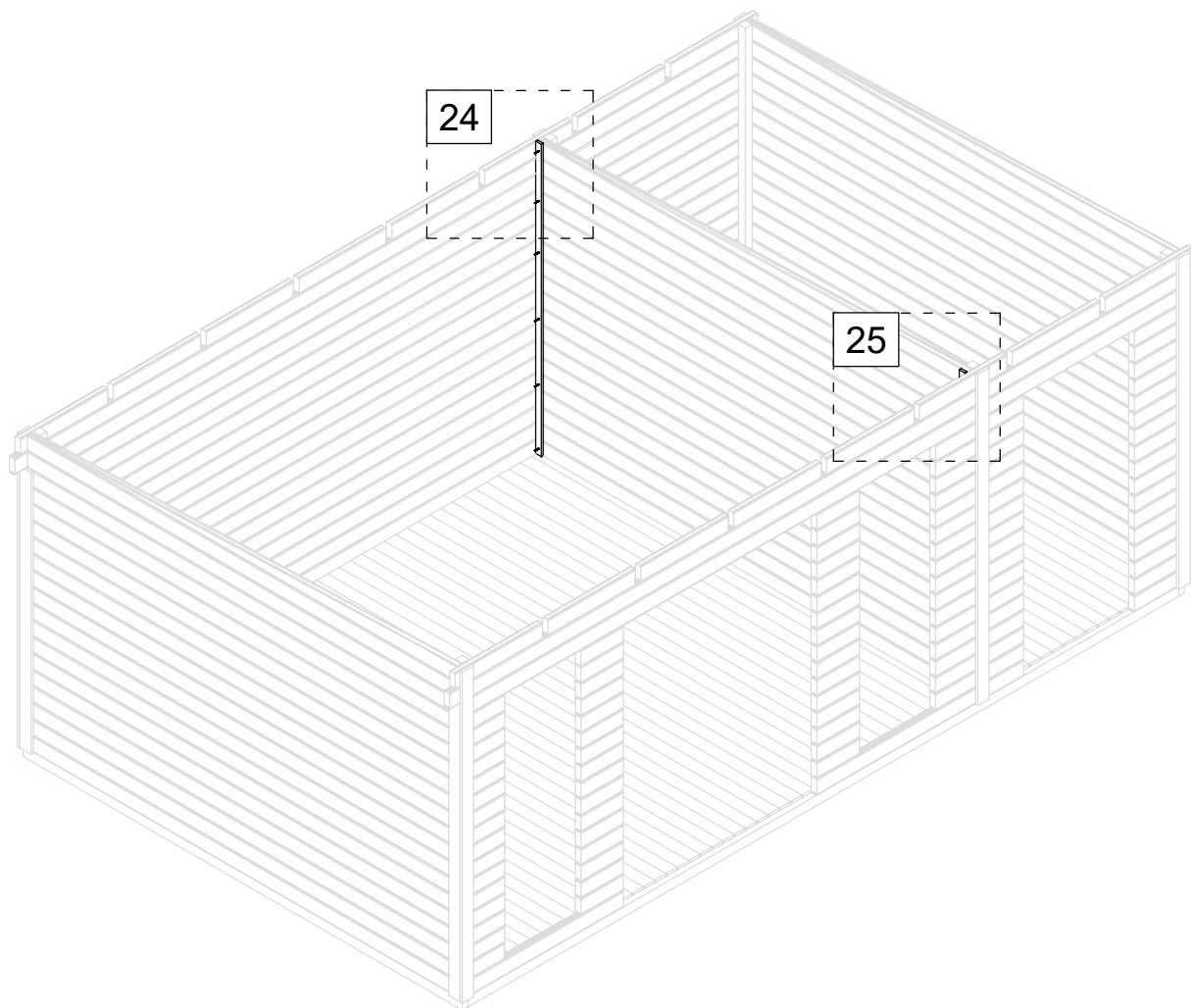

24

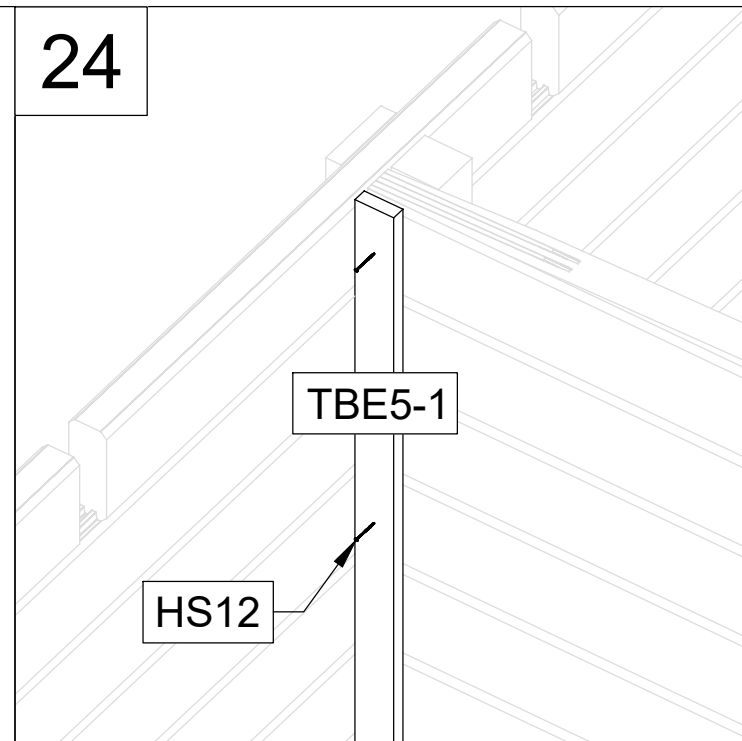

TBE5-1

HS12

25

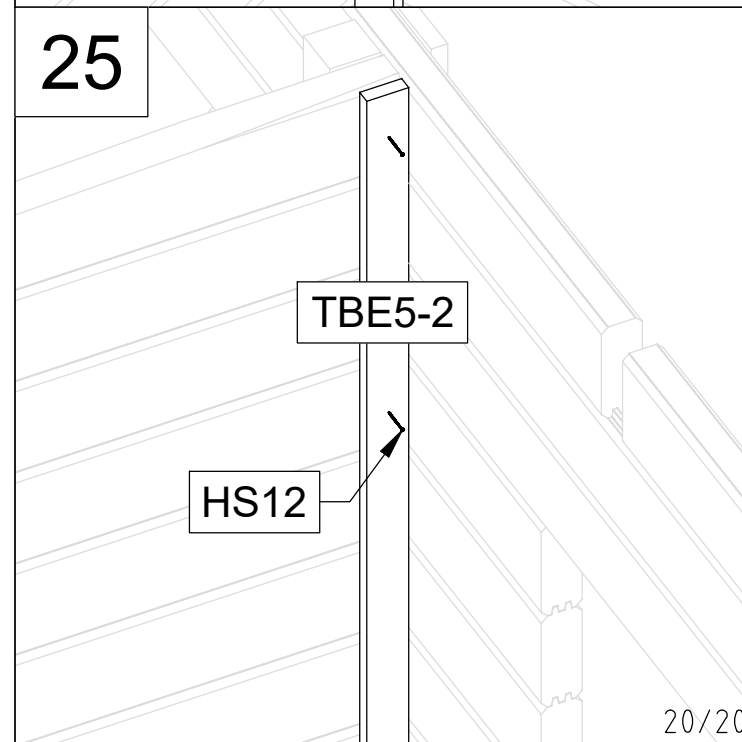

TBE5-2

HS12



Pos	10.11.2017	Piece list - Stückliste - Liste des pièces - Elementi - Stuklijst - Tükítabel 560x1780 AK.1.100.TPSP DGP+	1/1	Q	P (mm)	L (mm)
-----	------------	--------------------------------------------------------------------------------------------------------------	-----	---	-----------	-----------

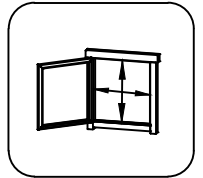
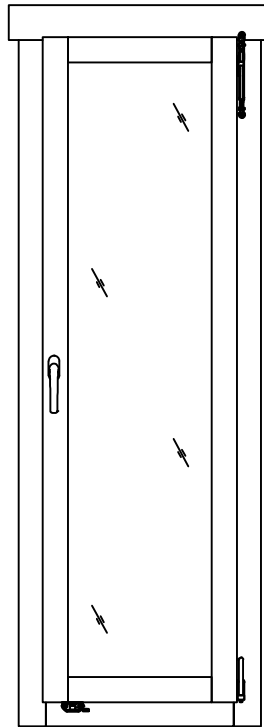



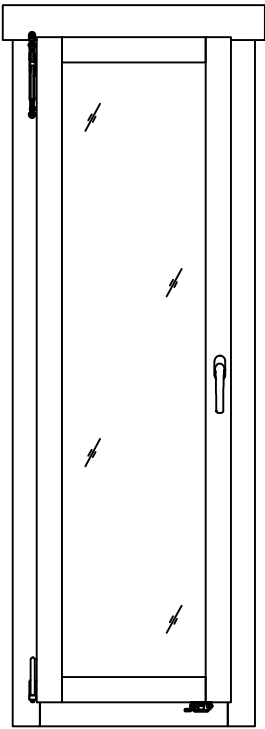
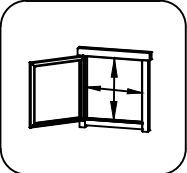

Glass size - Glasgröße - Taille de la vitre - Misura del vetro - Glas afmeting - Klaasi mõõt: 390x1602 mm



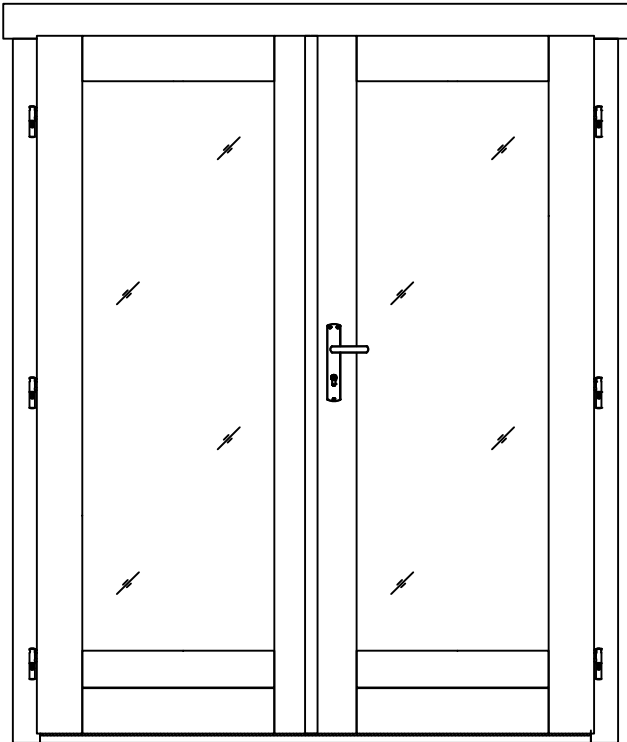
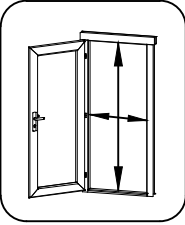
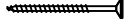
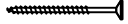
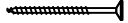

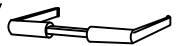

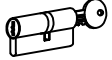

460x1684 mm

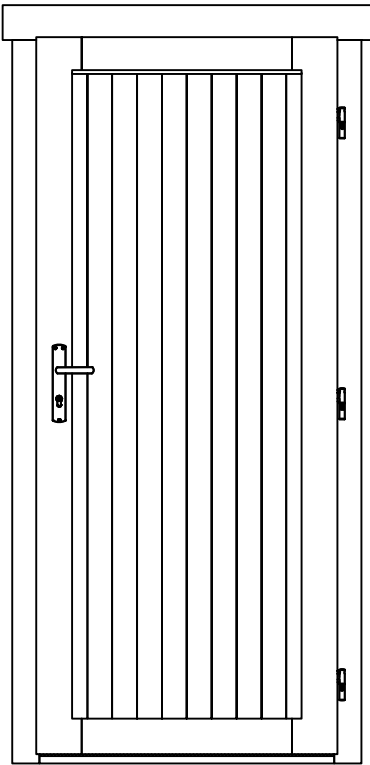
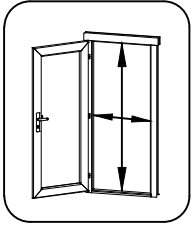
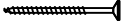
FS2	Window handle fittings - Fenstergriff - Poignée de fenetre - Maniglia c/ferramenta - Raamhendel -/grendel -/klink - Aknalink		1			
-----	---------------------------------------------------------------------------------------------------------------------------------	---------------------------------------------------------------------------------------	---	--	--	--

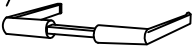
Pos	10.11.2017 Piece list - Stückliste - Liste des pièces - Elementi - Stuklijst - Tükitalbel 560x1780 AK.1.100.TPSV DGP+	1/1	Q	P (mm)	L (mm)
	<p data-bbox="255 152 1289 183">Glass size - Glasgröße - Taille de la vitre - Misura del vetro - Glas afmeting - Klaasi mõõt: 390x1602 mm</p>   <p data-bbox="1364 347 1497 376">460x1684 mm</p>				
FS2	<p data-bbox="255 2132 1024 2190">Window handle fittings - Fenstergriff - Poignee de fenetre - Maniglia c/ferramenta - Raamhendel -/grendel -/klink - Aknalink</p>		1		

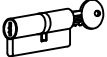
Pos	Piece list - Stückliste - Liste des pièces - Elementi - Stuklijst - Tükítabel 1494x1900 TUK.1.100.TPVP.MMj DGP+	1/1	Q	P (mm)	L (mm)
	<p>Glass size - Glasgröße - Taille de la vitre - Misura del vetro - Glas afmeting - Klaasi mõõt: 514x1536 mm</p>   <p>1394x1812 mm</p>				
HS4	Screw for door fillet - Schraube zur Befestigung Türleiste - Vis pour fixation baguette d'arrêt de porte - Viti per massellino della porta - Schroef voor deurlijst - Kruvi ukse kokkuvaltšiliistule		5	3x30	
HS16	Screw for door jamb - Schraube für Türrahmen - Vis de fixation partie haute avec montants du cadre de porte - Viti x fissaggio montanti porte - Schroef voor deurkozijn - Kruvi ukse lengile		4	5x90	
HS25	Screw for doorstep - Schrauben für Swelle - Vis pour fixation barre de seuil - Vite per soglia della porta - Schroef voor deurdorpel - Kruvi lävepakule		3	4.5x65	
MH	Male bolt hinge for door - Türband - Partie male de paumelle de porte - Cerniera anube x porta - Scharnier bout - Reguleeritav polthing isane		6	14x80	
HC	Covers for door hinges - Schutzkappe für Türband - Couverture de paumelle de porte - Copertura delle cerniere della porta - Afdek kap voor deurscharnier - Reguleeritava polthinge kate		12		
TL4	Door handle fittings - Türgriff - Poignée de porte - Maniglie - Deurhendel / klink - Ukse käepide		1		
TL5	Set of door lock covers - Schlossblenden - Set de garnitures de porte - Copertura serrature - Slot sluitplaat set - Ukse lukuplaat		1		
	Cylinder lock - Zylinderschloss - Barillet de porte - Serratura - Cylinder slot - Ukse lukusüdamik		1	30x35	
	Striker for barrel bolt - Hülse für Grendelriegel - Gache au sol du targette - Boccola per fermo della porta - Huls voor vergrendelingsschuif - Vasturaud ukse servariivile		2		

Pos	12.05.2016	Piece list - Stückliste - Liste des pièces - Elementi - Stuklijst - Tükítabel 835x1900 UL.2.100.IVP.MMWd TP+	1/1	Q	P (mm)	L (mm)
		  <p>735x1818 mm</p>				
HS16	Screw for door jamb - Schraube für Türrahmen - Vis de fixation partie haute avec montants du cadre de porte - Viti x fissaggio montanti porte - Schroef voor deurkozijn - Kruvi ukse lengile		4	5x90		
HS25	Screw for doorstep - Schrauben für swelle - Vis pour fixation barre de seuil - Vite per soglia della porta - Schroef voor deurdorpel - Kruvi lävepakule		2	4.5x65		
TL4	Door handle fittings - Türgriff - Poignée de porte - Maniglie - Deurhendel / klink - Ukse käepide VU		1			
TL5	Set of door lock covers - Schlossblenden - Set de garnitures de porte - Copertura serrature - Slot sluitplaat set - Ukse lukuplaat		1			
	Cylinder lock - Zylinderschloss - Barillet de porte - Serratura - Cylinder slot - Ukse lukusüdamik		1	30x35		
	Male bolt hinge for door - Türband - Partie male de paumelle de porte - Cerniera anube x porta - Scharnier bout - Ukse polthing isane		3			
HC	Covers for door hinges - Schutzkappe für Türband - Couverture de paumelle de porte - Copertura delle cerniere della porta - Afdek kap voor deurscharnier - Reguleeritava polthinge kate		6			