

Murano 2
Art. Nr. 4429719
1/23

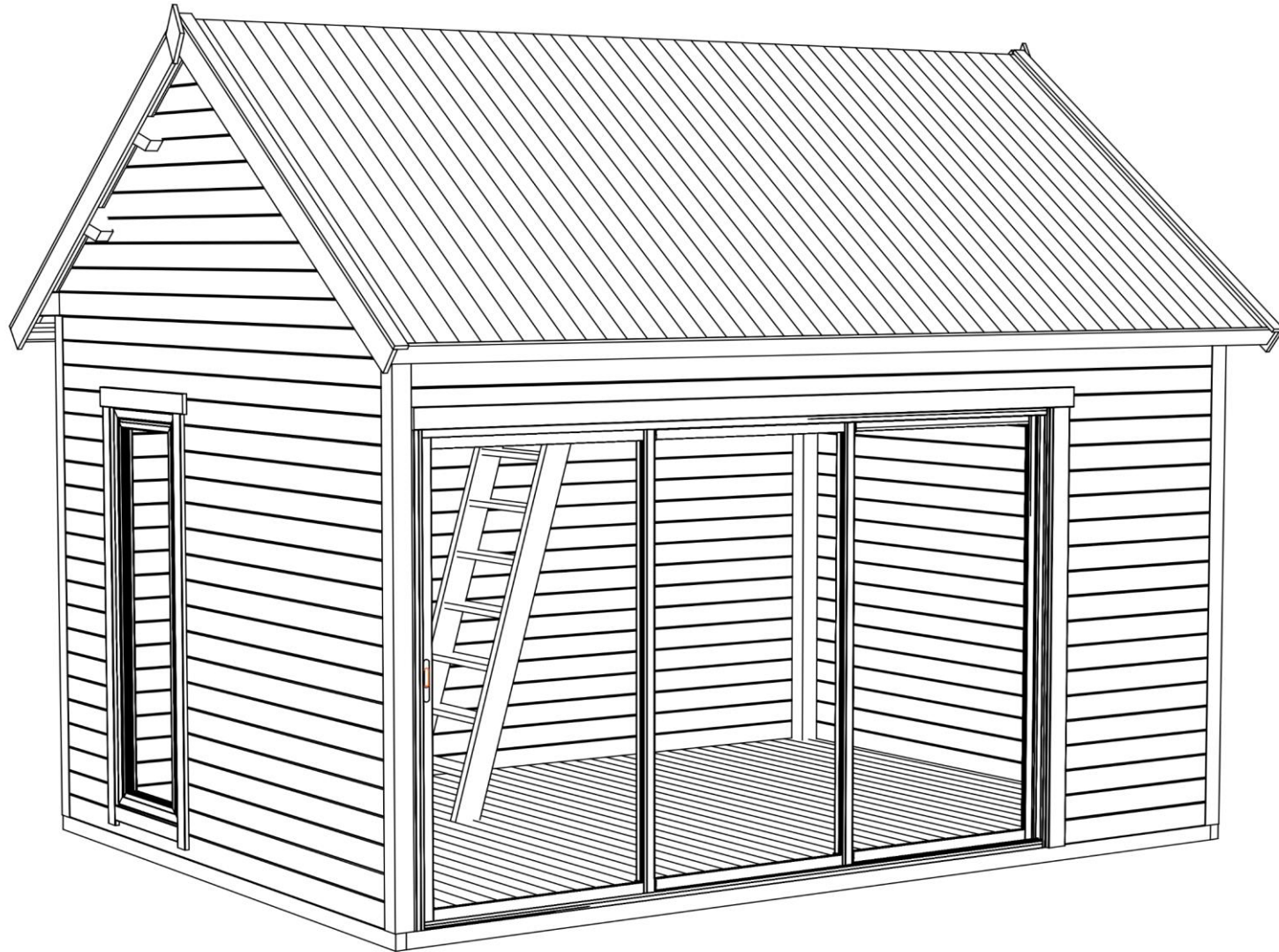

18.04.2023

Art. Nr. 4429719

Groundplan - Grundplan - Plan de masse -
Planimetria - Plattegrond - Põhiplaan

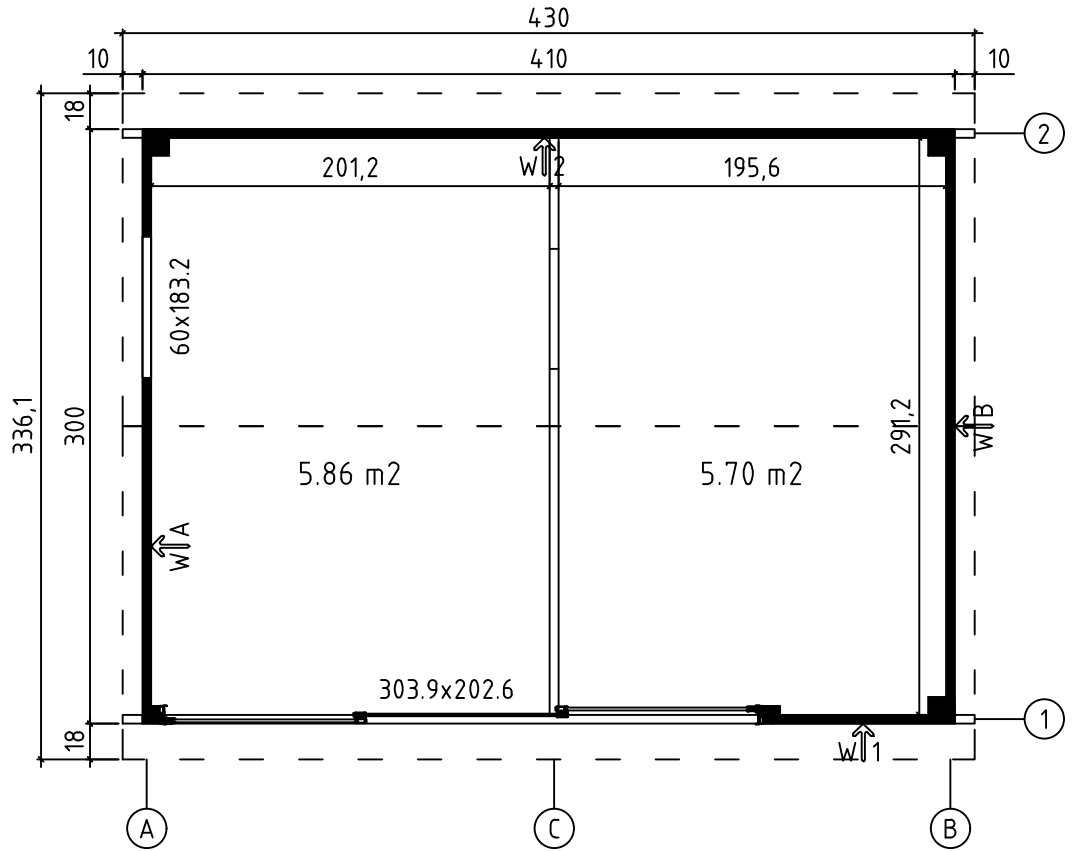

Foundation - Fundament - Fondation - Fondamenta - Fundering -
Immutatud alusraam

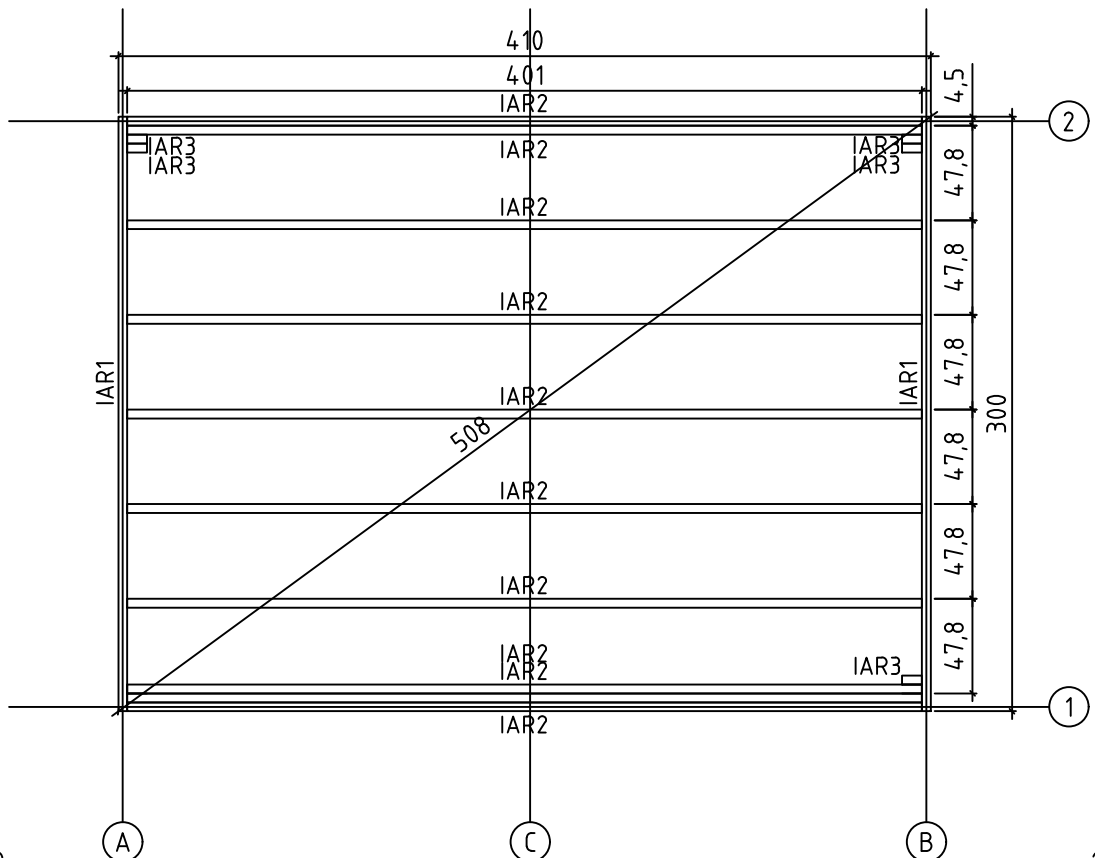

Floor boards - Fussbodenbretter - Plan pose plancher - Pavimento -
Vloerhout - Põrandalaudis

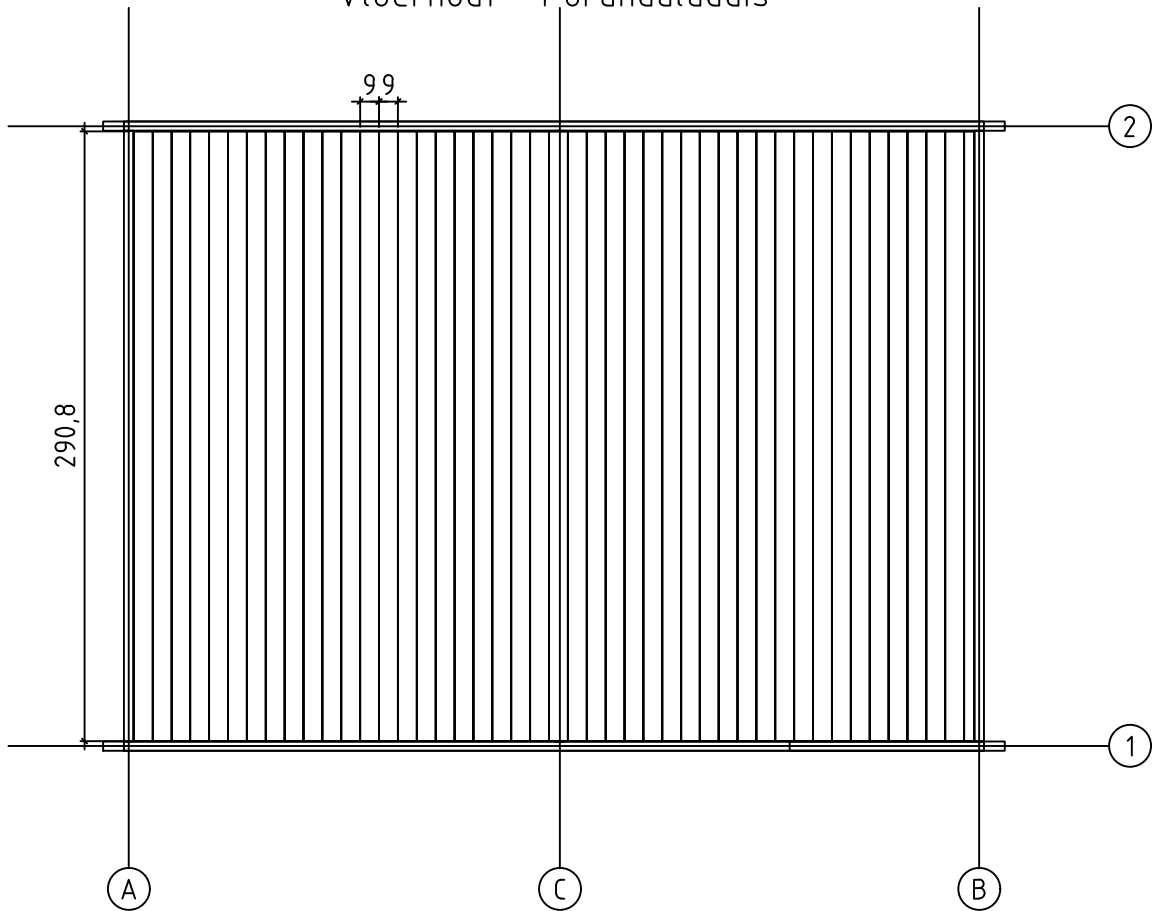

Floor boards - Fussbodenbretter - Plan pose plancher - Pavimento -
Vloerhout - Põrandalaudis

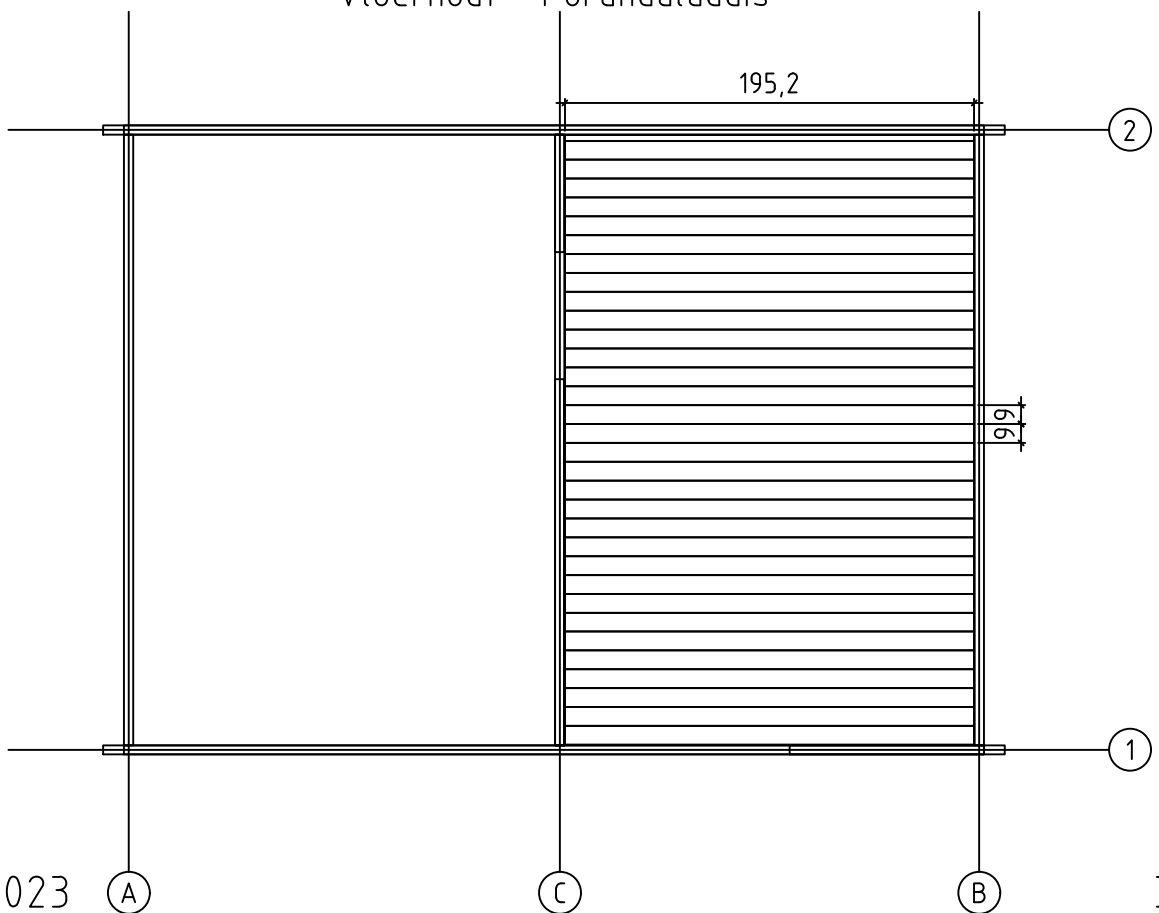



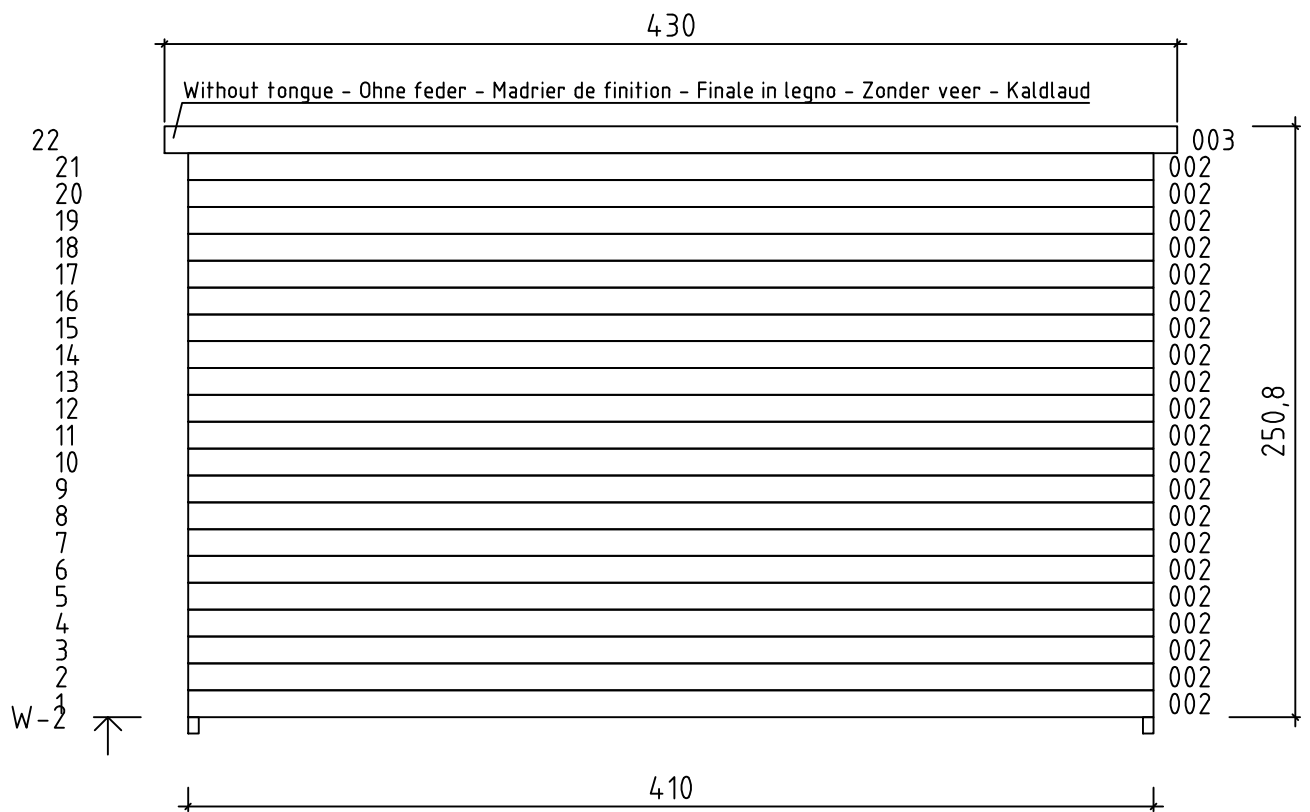
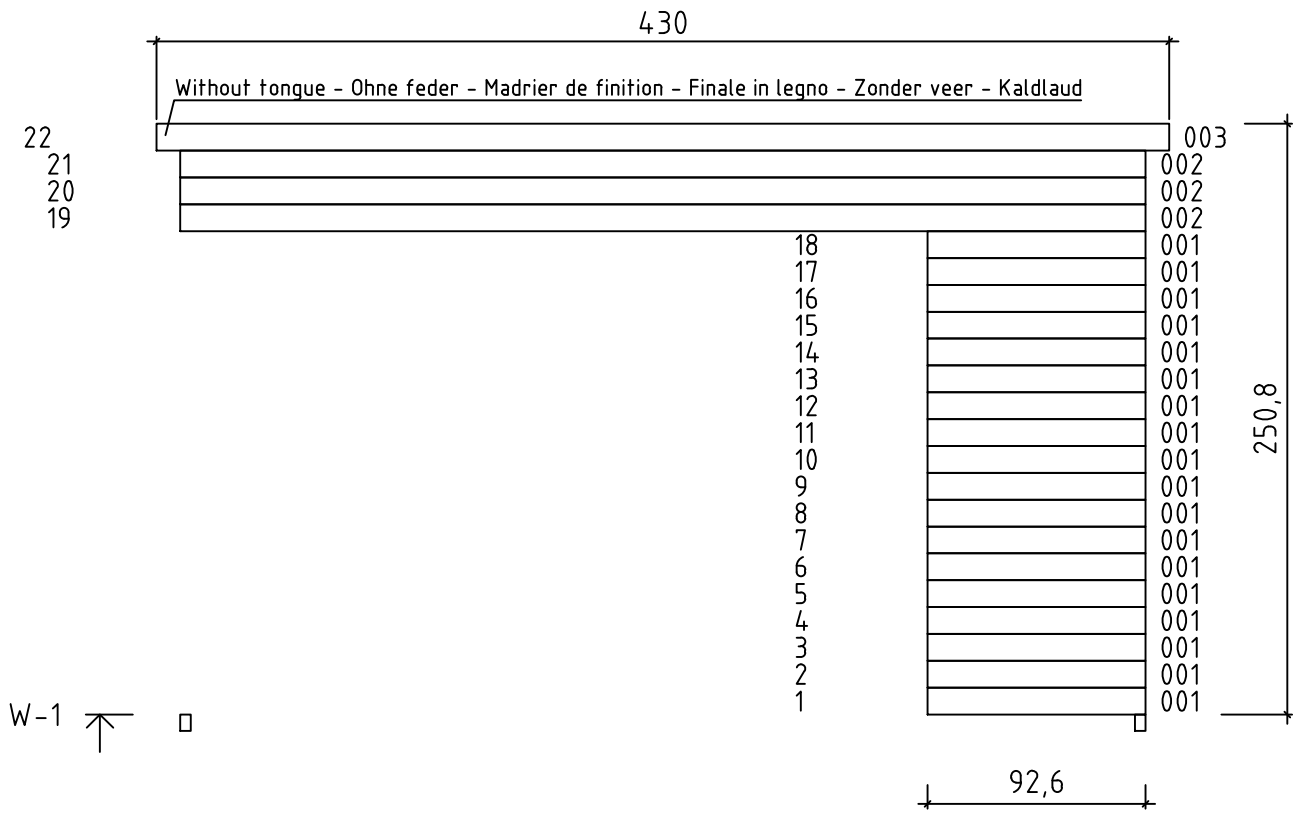



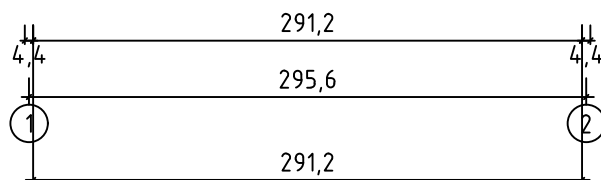
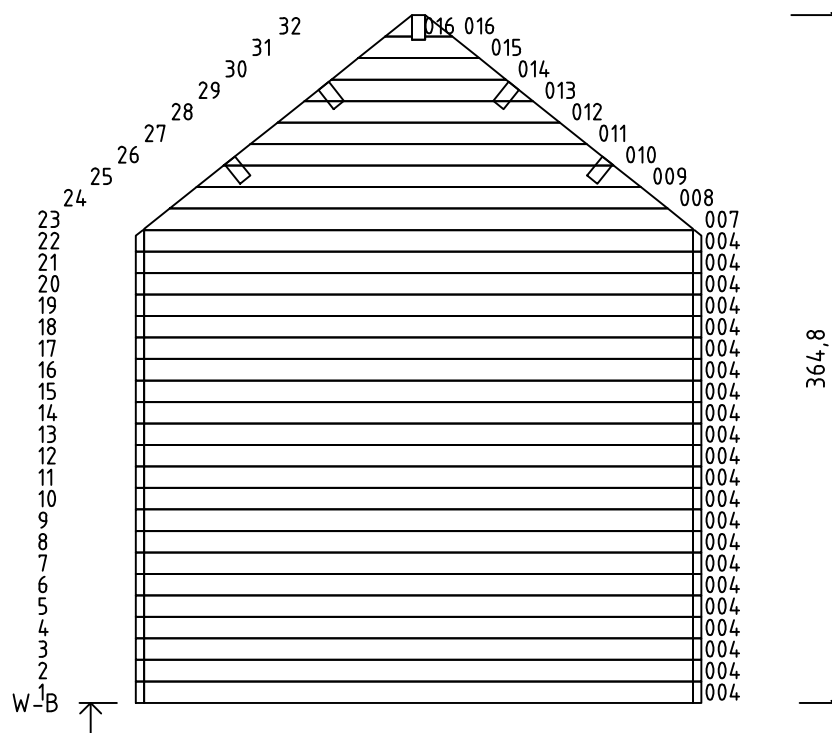
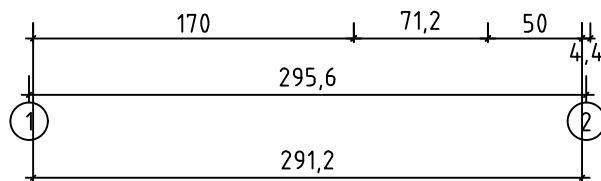
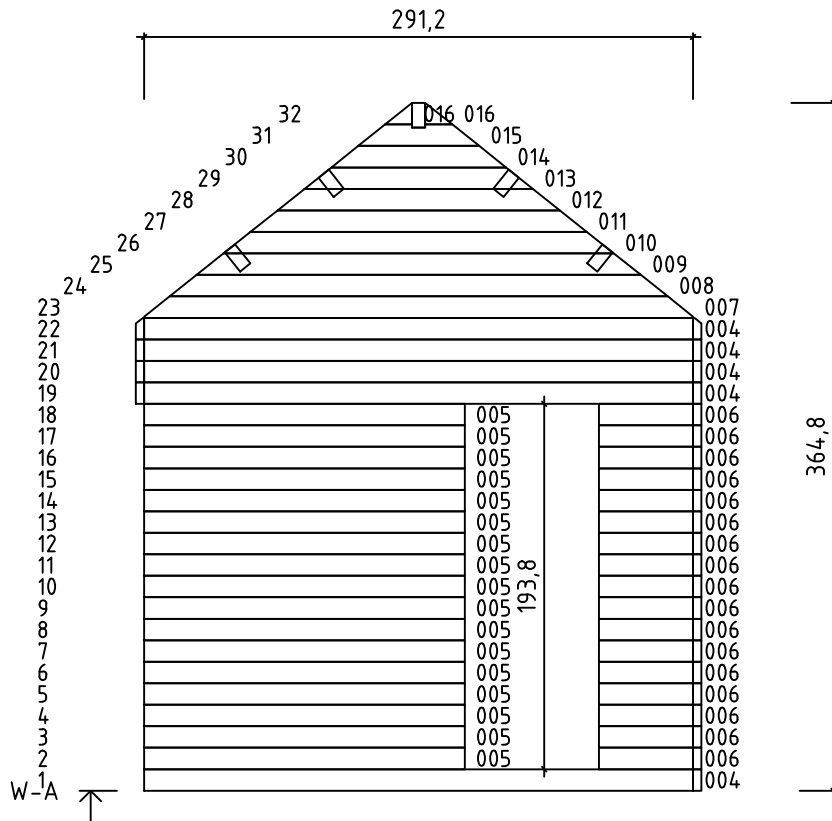

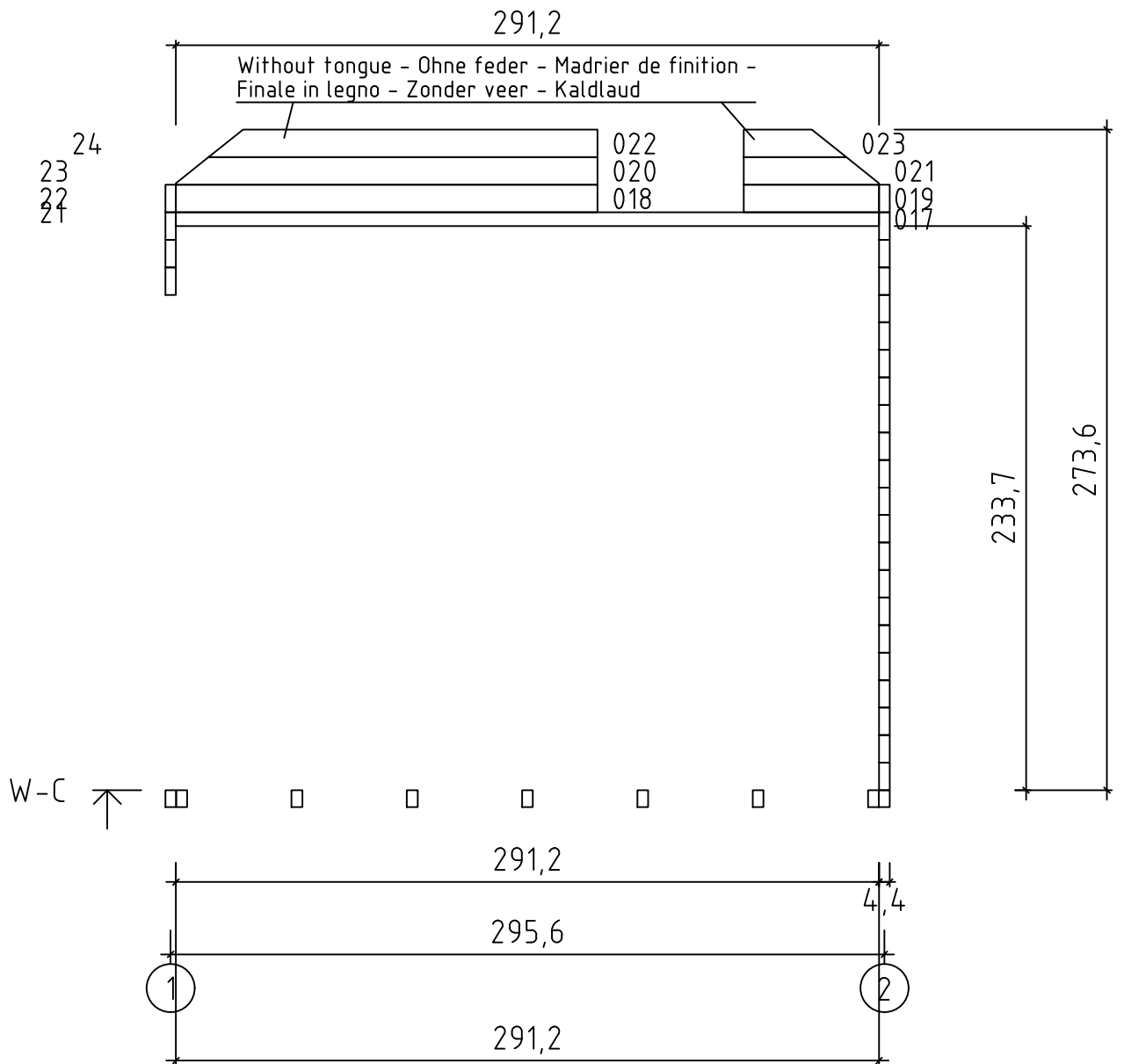

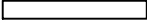
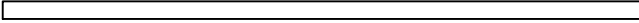
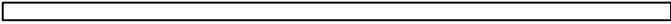
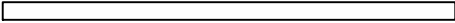
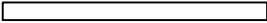
Art. Nr. 4429719

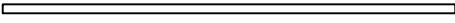
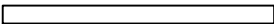

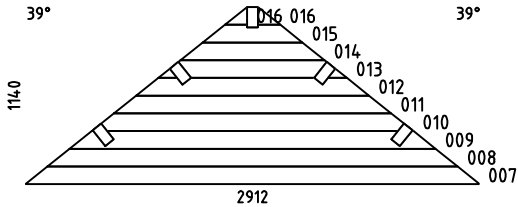
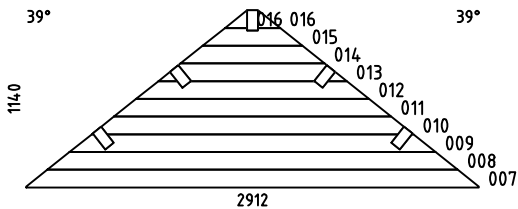



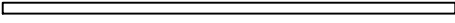
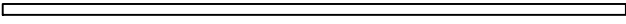
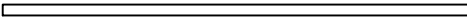







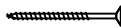
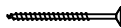
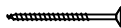
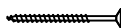
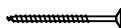
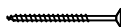
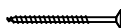
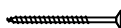

Art. Nr. 4429719

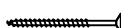



Pos	18.04.2023 Piece list - Stückliste - Liste des pièces - Elementi - Stuklijst - Tükitalad Art. Nr. 4429719 7/23	Q	P (mm)	L (mm)
001 44300		18	44x114	926
002 44301		24	44x114	4100
003 44303	D 	2	44x120	4300
004 21421		27	44x114	2912
005 44304		17	44x114	1700
006 28276		17	44x114	500
017 35705		1	44x57	2912
018 44305		1	44x114	1746
019 22605		1	44x114	560
WA-1 44306		1		
WB-1 44306		1		
WC-1		1		
VT1 35708	Mezzanine floor joists - Halbgeschoss balken - Solives de plancher mezzanine - Travi del pavimento mezzanino - Plaatduim scharnier - Vahelaetalad 	5	44x140	2912
VT3 44330	Mezzanine floor joists - Halbgeschoss balken - Solives de plancher mezzanine - Travi del pavimento mezzanino - Plaatduim scharnier - Vahelaetalad 	1	44x140	2732
VT4 44331	Mezzanine floor joists - Halbgeschoss balken - Solives de plancher mezzanine - Travi del pavimento mezzanino - Plaatduim scharnier - Vahelaetalad 	2	44x140	1910
VT2 45756	Mezzanine floor joists - Halbgeschoss balken - Solives de plancher mezzanine - Travi del pavimento mezzanino - Plaatduim scharnier - Vahelaetalad 	1	44x70	2912
IAR2 44307	Foundation - Fundament - Fondation - Fondamenta - Fundering - Immutatud alusraam 	10	45x70	4010
IAR1 37391	Foundation - Fundament - Fondation - Fondamenta - Fundering - Immutatud alusraam 	2	45x70	3000
IAR3 34041	Foundation - Fundament - Fondation - Fondamenta - Fundering - Immutatud alusraam 	5	45x70	100

Pos	18.04.2023 Piece list - Stückliste - Liste des pièces - Elementi - Stuklijst - Tükítabel Art. Nr. 4429719 8/23	Q	P (mm)	L (mm)
A-PR1 44332	Roof beam - Dachbalken - Panne de toit - Perlina del tetto - Gordingen / dakbalk - Pärтин 	5	70x140	4300
FB1 1518	Floor boards - Fussbodenbretter - Lamé de plancher - Pavimento - Vloerhout - Pörandalaud 	45	90x18	2908
FB2 21451	Floor boards - Fussbodenbretter - Lamé de plancher - Pavimento - Vloerhout - Pörandalaud 	33	90x18	1952
RB 36628	Roof boards - Dachbretter - Voliges - Perlina per tetto - Dakhout - Katuselaud 	96	90x18	2150
30087	Floor fillet - Fussbodenteiste - Corniere de finition du plancher - Finitura per pavimento (battisco pa) - Vloerafwerklijst - Pörandaliist 		18x18	25
RFF 14953	Roofing felt fillet - Dachpappenleiste - Baguette de fixation du feutre bitumeux - Asse per fissaggio guaina bituminosa - Afdekljst asfaltpapier - Katusepapiiist 	4	18x58	2200
TL1 43512	Covering moulding - Deckungsprofil - Profils de finition verticaux a fixer a l'exterieur du cadre de la porte - Cornice di finitura - Afdek profiel - Lengipuu 	2	38x46	612
TL2 42950	Covering moulding - Deckungsprofil - Profils de finition verticaux a fixer a l'exterieur du cadre de la porte - Cornice di finitura - Afdek profiel - Lengipuu 	2	38x46	1900
FF1 38454	Fixing fillet - Fixierungsleiste - Profil de fixation - Massello di fissaggio - Bevestiging lijstwerk - Tenderliist 	1	11x30	2998
PL1 42937	Railing strip - Begrenzungsleiste - Rembarde - Sbarra - Afscheidingslijst - Piirdelaud 	2	18x70	612
PL2 44297	Railing strip - Begrenzungsleiste - Rembarde - Sbarra - Afscheidingslijst - Piirdelaud 	4	18x70	1939
PL3 35597	Railing strip - Begrenzungsleiste - Rembarde - Sbarra - Afscheidingslijst - Piirdelaud 	1	18x70	2000
PL4 42940	Railing strip - Begrenzungsleiste - Rembarde - Sbarra - Afscheidingslijst - Piirdelaud 	2	18x90	802
PL5 44212	Railing strip - Begrenzungsleiste - Rembarde - Sbarra - Afscheidingslijst - Piirdelaud 	1	18x90	3040
PL6 37903	Railing strip - Begrenzungsleiste - Rembarde - Sbarra - Afscheidingslijst - Piirdelaud 	1	18x90	3150
P1 44209	Post - Pfosten - Poteau - Piede registrabile - Stijl - Post 	1	88x88	2052
P2 44207	Post - Pfosten - Poteau - Piede registrabile - Stijl - Post 	1	88x88	2500
P3 43507	Post - Pfosten - Poteau - Piede registrabile - Stijl - Post 	3	90x90	2500
TB 2247	Fascia board - Traufbrett - Bandeau de toit - Finitura lati tetto - Gevellijst Räästalaud 	2	18x90	4300
DRV 2248	Roof edge reinforcement - Dachrandverstärkung - Corniere de renfort de bord de toit - Rinforzo x tetto - Dakrand versterking - Räästatugevdus 	2	28x34	4300
24653	Ladder - Leiter - Echelle - Scala a pioli - Ladder - Redel 	9	28x120	542
44236 44237	Ladder - Leiter - Echelle - Scala a pioli - Ladder - Redel 	2	44x120	2750
FF2 39848	Fixing fillet - Fixierungsleiste - Profil de fixation - Massello di fissaggio - Bevestiging lijstwerk - Tenderliist 	2	18x44	1900

Pos	18.04.2023 Piece list - Stückliste - Liste des pièces - Elementi - Stuklijst - Tükítabel Art. Nr. 4429719 9/23	Q	P (mm)	L (mm)
FF3 44388	Fixing fillet - Fixierungsleiste - Profil de fixation - Massello di fissaggio - Befestigung lijstwerk - Tenderliist 	2	18x44	2000
FF4 38464	Covering moulding - Deckungsprofil - Profils de finition verticaux a fixer a l'exterieur du cadre de la porte - Cornice di finitura - Afdek profiel - Lengipuu 	1	38x46	2998
GL 42375	Gable moulding - Giebelleiste - Planche de rive - Finitura per frontale e retro del tetto - Gevellijst - Viilulaud 	4	18x120	2200
HS8 5105	Screw for gable segment - Schrauben für deckblatt - Vis pour fixation losange de finition - Viti x frontali tetto - Schroef voor gevelpunt segment - Kruvi rombile 	4	3.5x35	
HS9 5106	Screw for gable moulding - Schrauben für giebelleiste - Vis pour fixation planche de rive - Vite per fissare finiture davanti e dietro del tetto - Schroef voor gevellijst - Kruvi viilulauale 	32	3.5x50	
HS32 5107	Screw for door jamb - Schraube für türrahmen - Vis de fixation partie haute avec montants du cadre de porte - Viti x fissaggio montanti porte - Schroef voor deurkozijn - Kruvi ukse lengile 	10	4.5x25	
HS14 5111	Screw for stairs - Schraube für treppen - Vis pour escalier - Vite per le scale - Schroef voor trap - Kruvi trepile 	36	4.5x80	
HS12 5109	Screw for covering moulding - Schrauben für deckungsprofil - Vis de fixation profils horizontaux haut inférieur et extérieur d'encadrement de porte - Vite per cornice di copertura - Schroef voor afdekprofiel - Kruvi piirdelauale 	80	4x40	
HS12 5109	Screw for universal hook - Schrauben für universalhaken - Vis pour crochets universels - Vite per gancio universale - Schroef voor universele haak - Kruvi redeli fiksaatorile 	4	4x40	
HS12 5109	Screw for fascia boards - Schrauben für traufbretter - Vis pour fixation bandeau de toit - Viti x striscia del tetto - Schroef voor gevellijst - Kruvi räästalauale 	20	4x40	
HS12 5109	Screw for roof edge reinforcement - Schrauben für dachrandverstärkung - Vis pour fixation corniere renfort de bord de toit - Viti x rinforzo bordo tetto - Schroef voor dakrand versterking - Kruvi räästatugevdusele 	20	4x40	
HS12 5109	Screw for fixing fillet of door and window - Schrauben für fixierungsteiste - Vis pour profil vertical de fixation pour ouvertures des fenetres et portes - Viti per massello di fissaggio - Schroeven voor bevestiging van deur en raam lijsten - Kruvi tenderliistudele 	34	4x40	
HS12 5109	Screw for door jamb - Schraube für türrahmen - Vis de fixation partie haute avec montants du cadre de porte - Viti x fissaggio montanti porte - Schroef voor deurkozijn - Kruvi ukse lengile 	10	4x40	
HS18 5113	Screw for roof beams - Schrauben für dachbalken - Vis pour fixation pannes de toit - Viti per perline del tetto - Schroef voor gordingen / dakbalken - Kruvi pärlinitel 	10	5x120	
HS18 5113	Screw for beam - Schrauben zur befestigung dachsparren - Vis pour solive (s) - Viti per pertine - Schroef voor balk (gording) - Kruvi talale 	10	5x120	
HS18 5113	Screw for gable - Schrauben für giebel - Vis pour fixation des pignons - Viti per timpano - Schroef voor gevelpunt - Kruvi viilude kinnitamiseks 	4	5x120	
HS33 5112	Screw for door jamb - Schraube für türrahmen - Vis de fixation partie haute avec montants du cadre de porte - Viti x fissaggio montanti porte - Schroef voor deurkozijn - Kruvi ukse lengile 	12	5x40	
HS34 40958	Screw for wall details - Schraube für wand details - Vis pour mur details - Viti per elementi della porta - Schroef voor wand details - Kruvi seinte montaaziks 	360	5x80	
HS16 5115	Screw for 1. wall beam - Schraube für 1. bohlenreihe - Vis de fixations 1ere rangée de madriers avec poutrelles de fondations - Vite fissaggio alle fondamenta - Schroef voor 1 wandbalk - Kruvi poollauale 	6	5x90	
HS16 5115	Screw for window jamb - Schraube für fensterrahmen - Vis de fixation pour montant de fenetre - Viti per finestra ad oblo - Schroef voor vensterbank - Kruvi akna lengile 	4	5x90	
HS16 5115	Screw for foundation - Schrauben zur befestigung fundament - Vis de fixations des poutrelles de fondations - Viti x fondamenta - Schroef voor fundering - Kruvi alusraamile 	32	5x90	
HS16 5115	Screw for door jamb - Schraube für türrahmen - Vis de fixation partie haute avec montants du cadre de porte - Viti x fissaggio montanti porte - Schroef voor deurkozijn - Kruvi ukse lengile 	6	5x90	
GS 32614	Gable segment - Deckblatt - Losange de finition - Decorazione in legno x frontale tetto - Gevelpunt segment - Romb 	2		

Art. Nr. 4429719

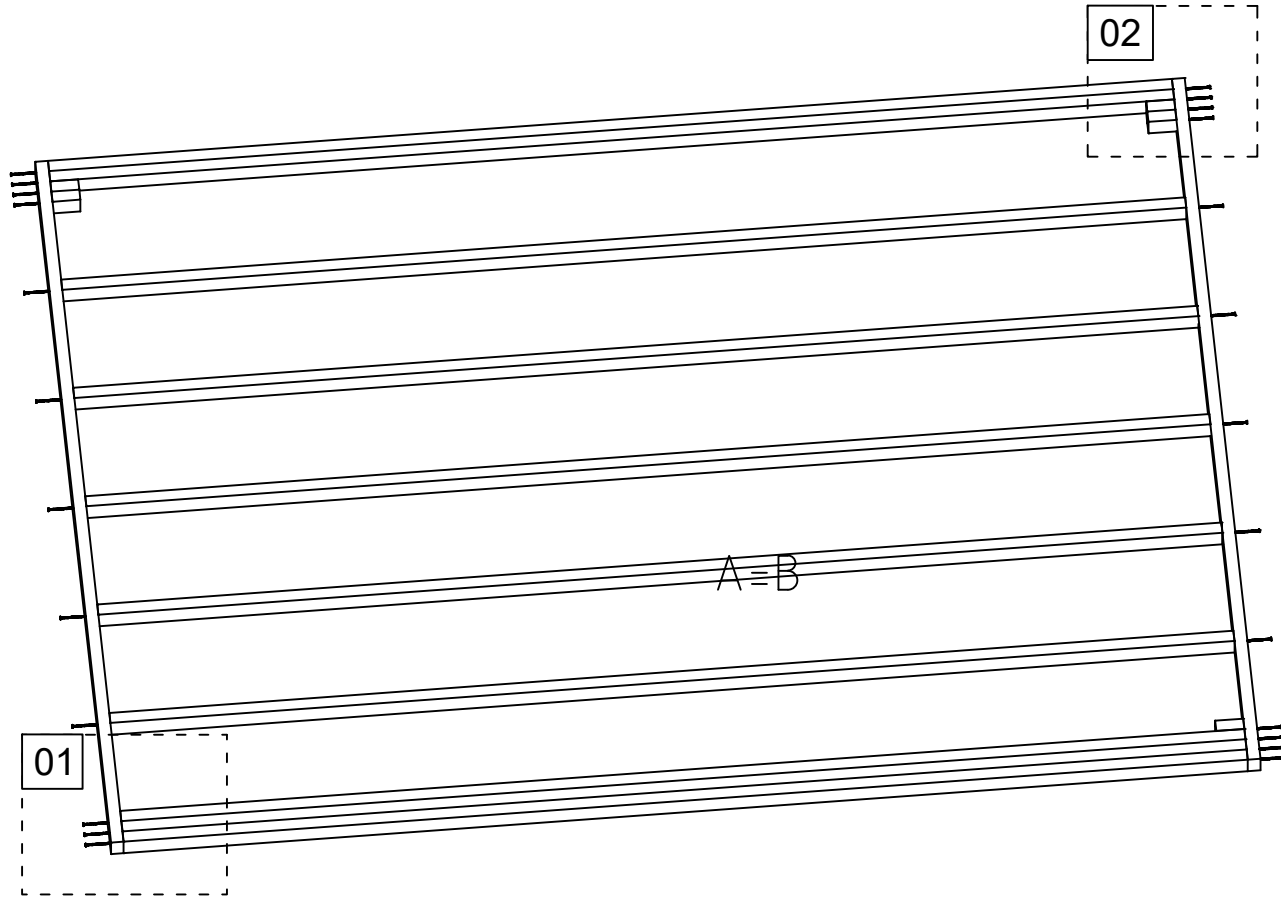

18.04.2023

01

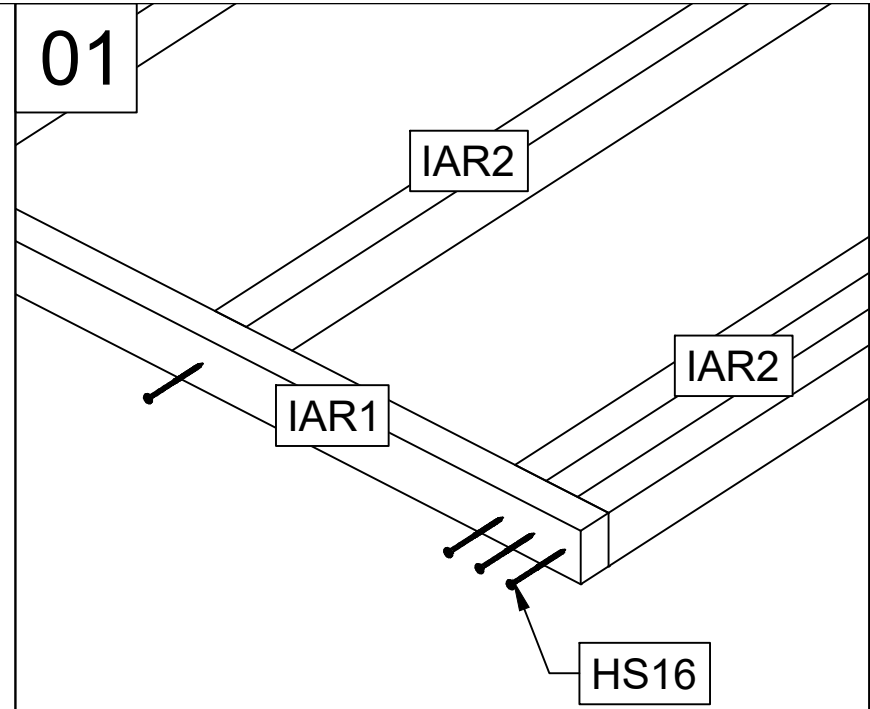

02

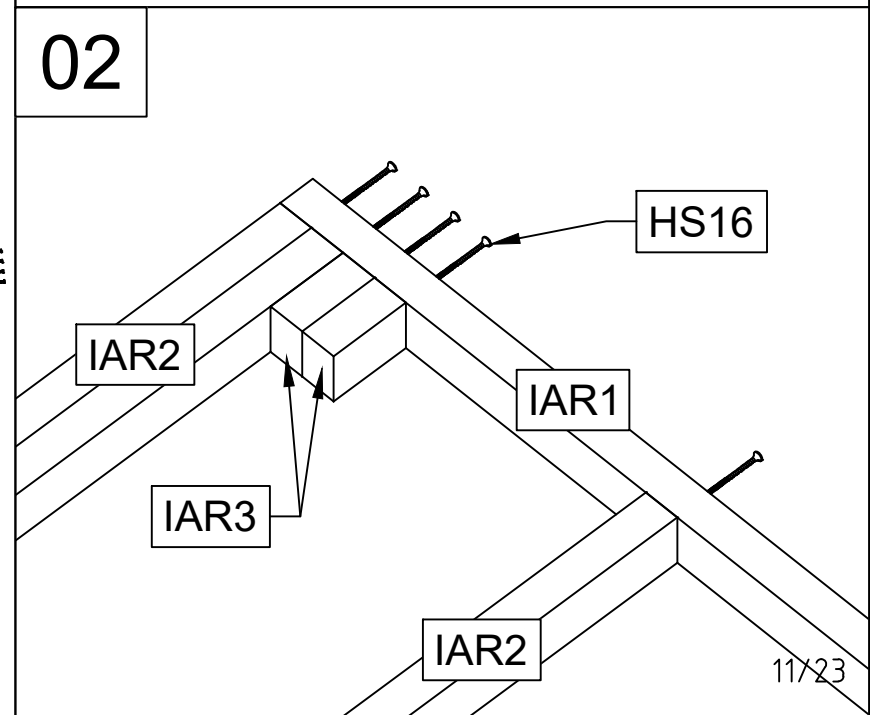

11/23

Art. Nr. 4429719

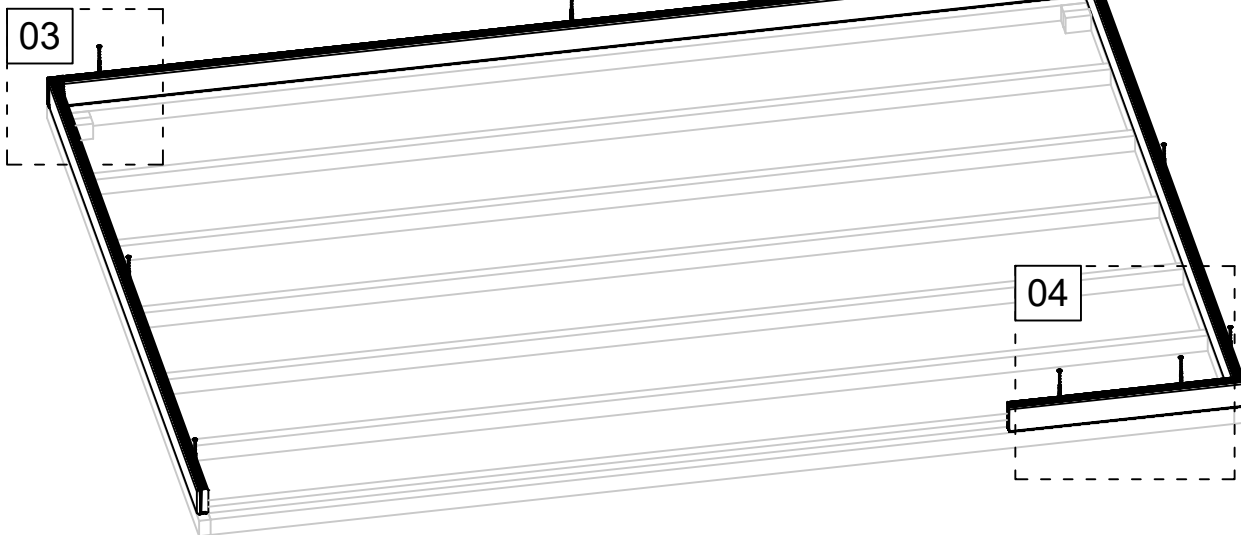

03

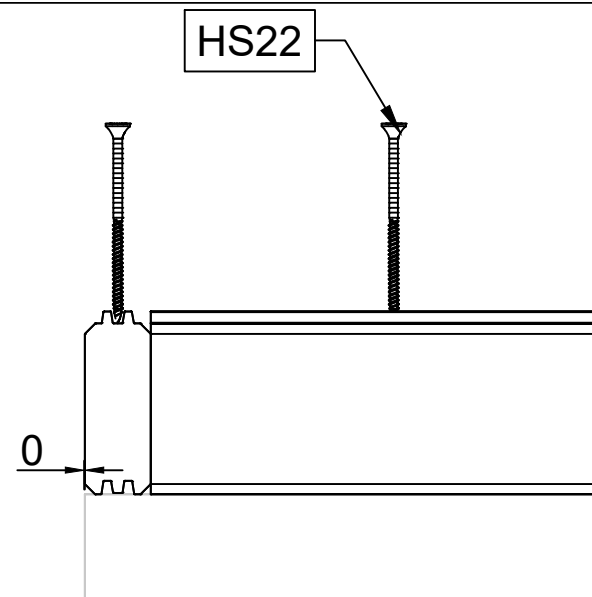

04

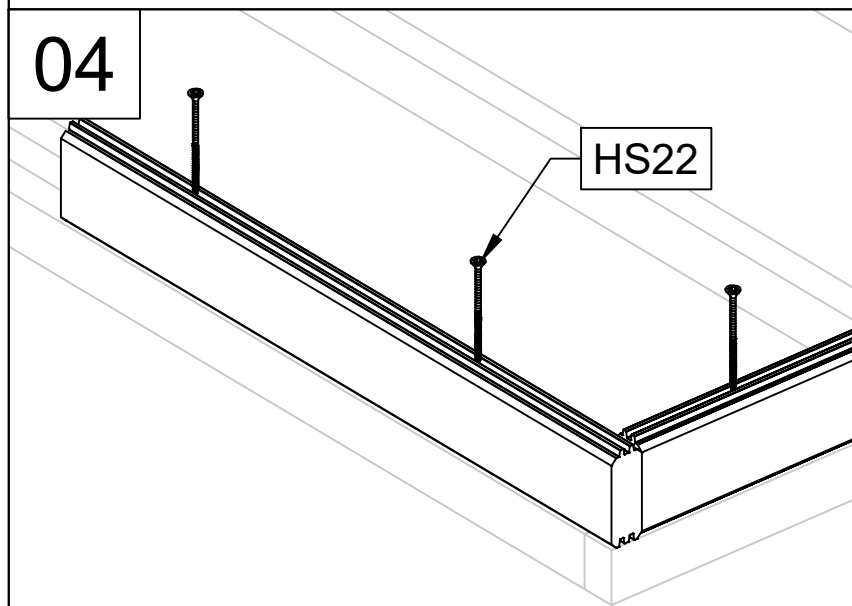

Art. Nr. 4429719

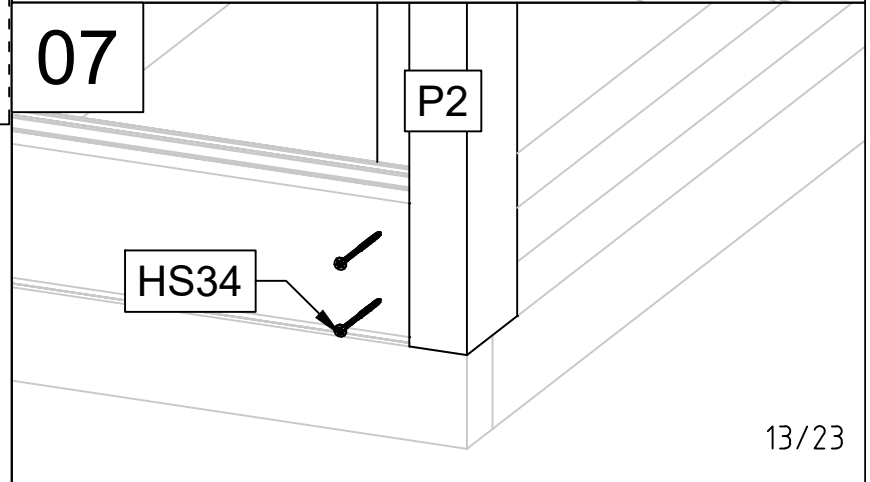
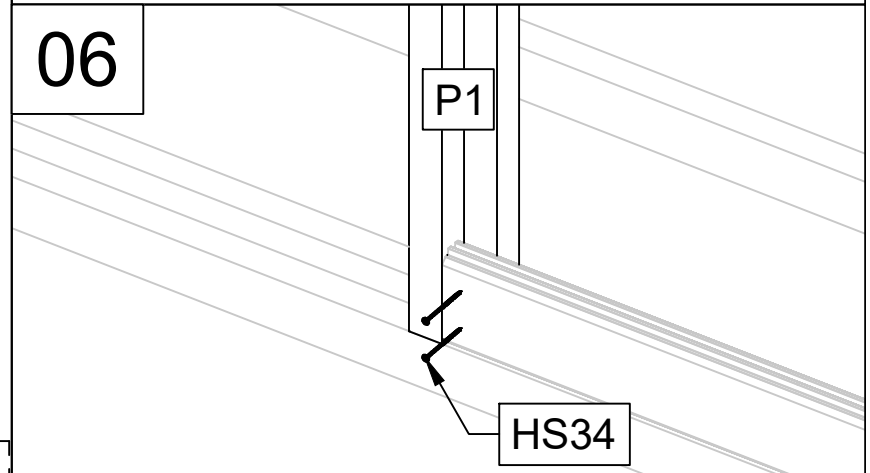
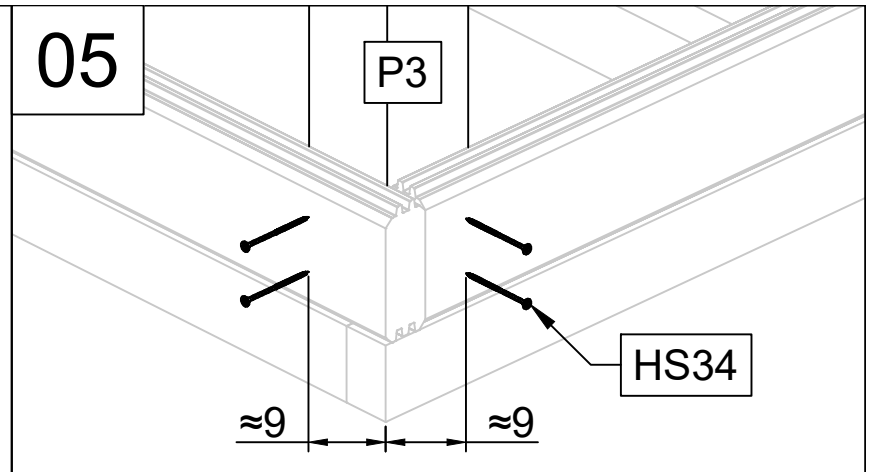
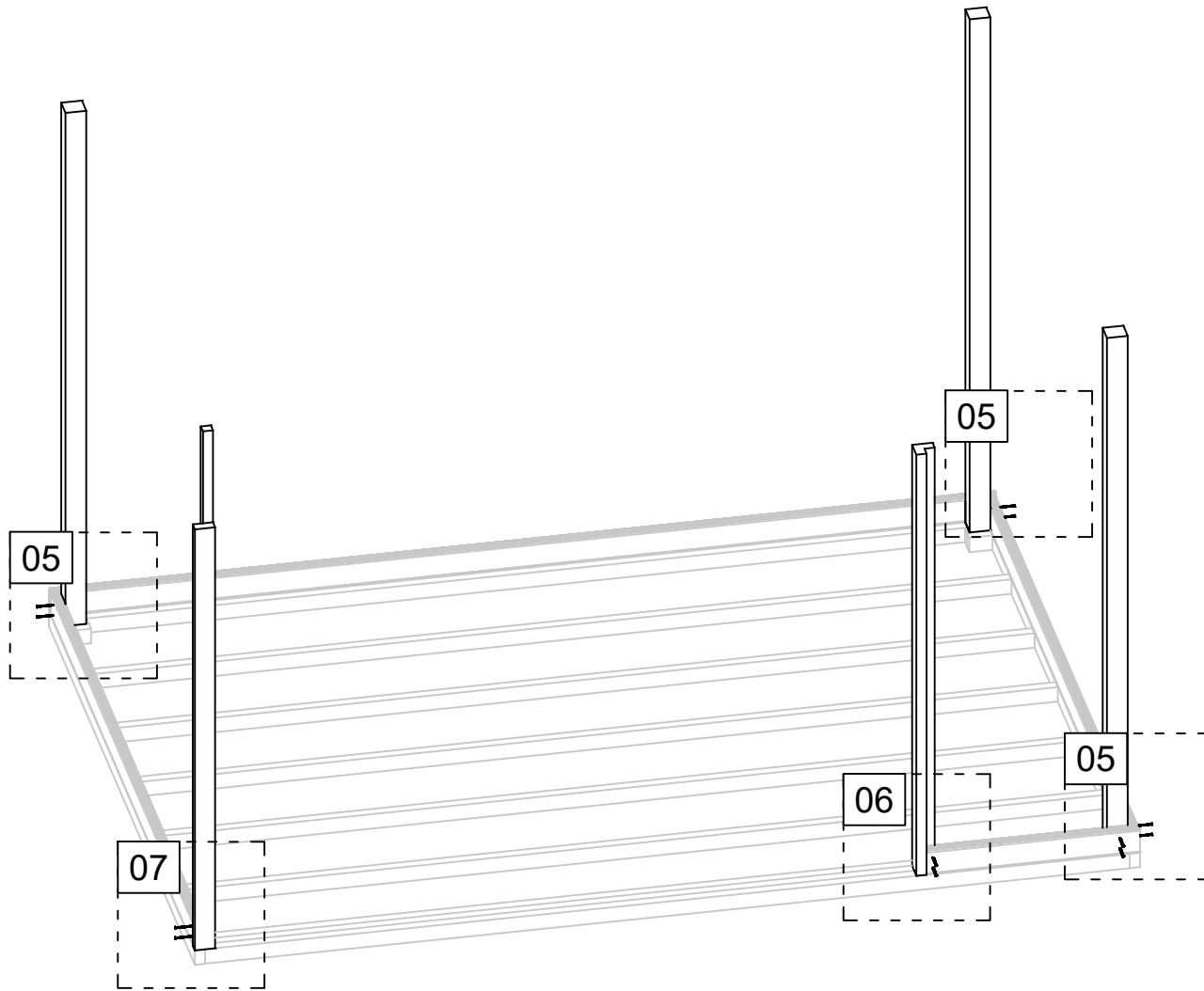

Art. Nr. 4429719

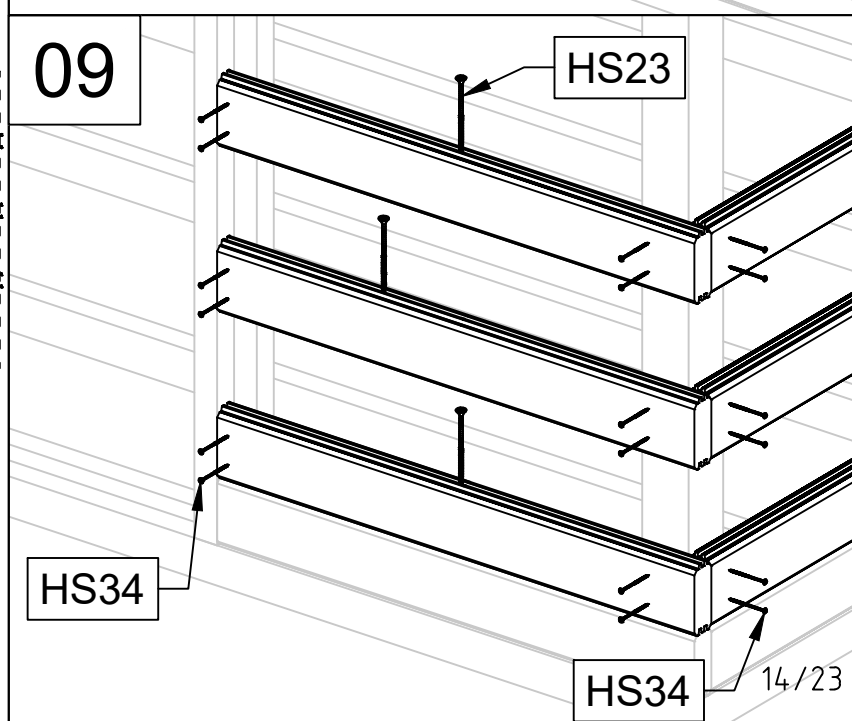
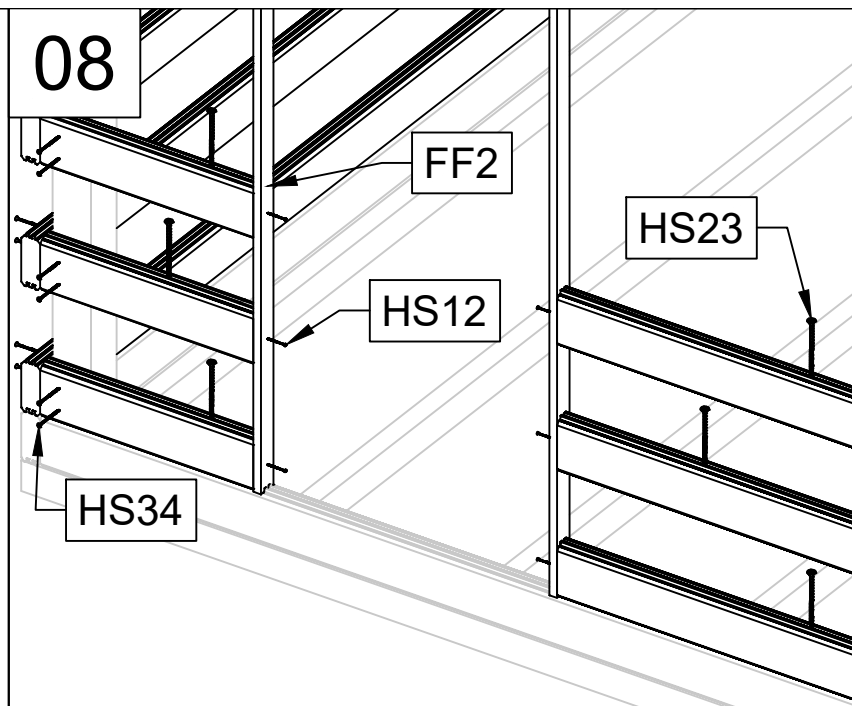
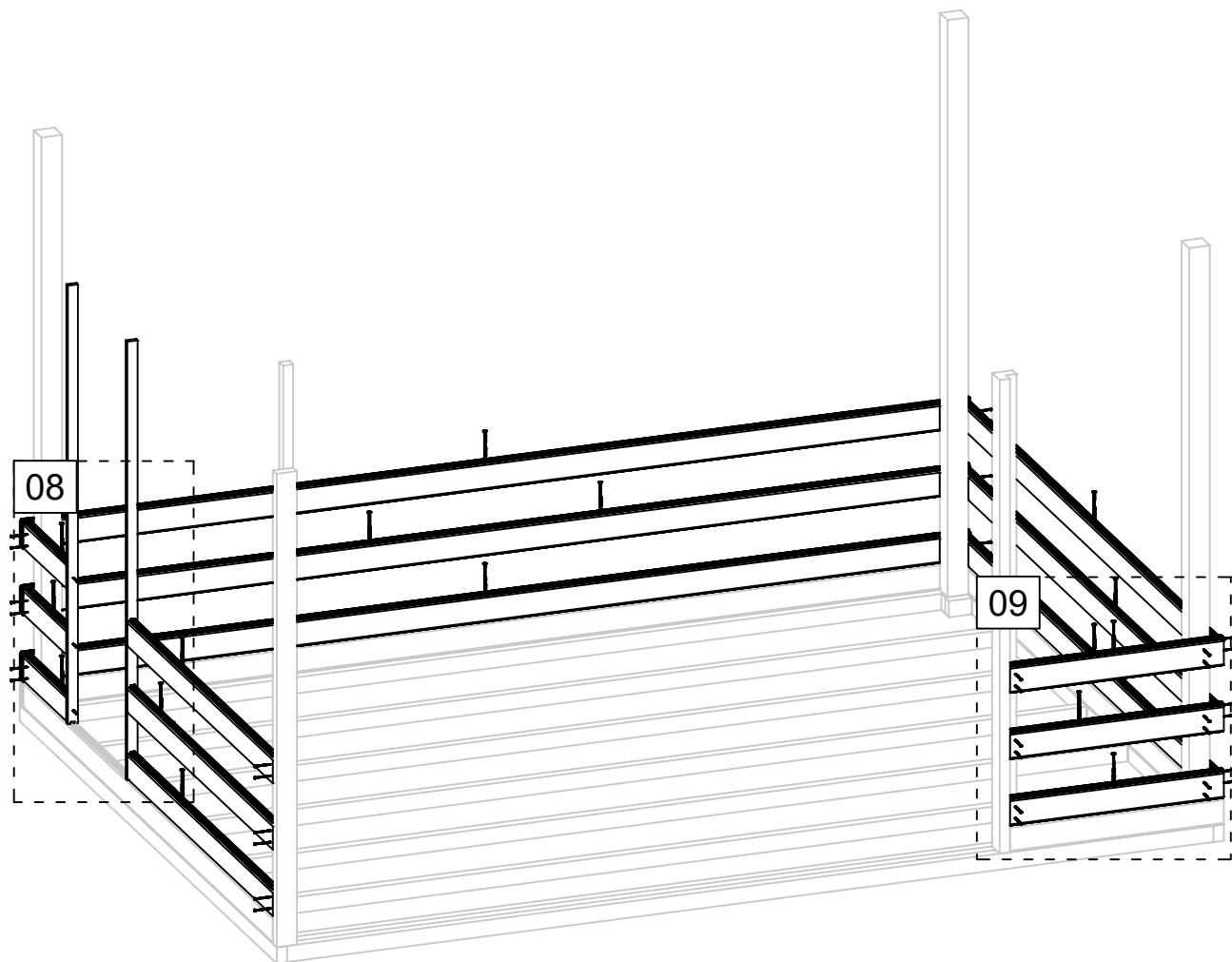

18.04.2023

14/23

Art. Nr. 4429719

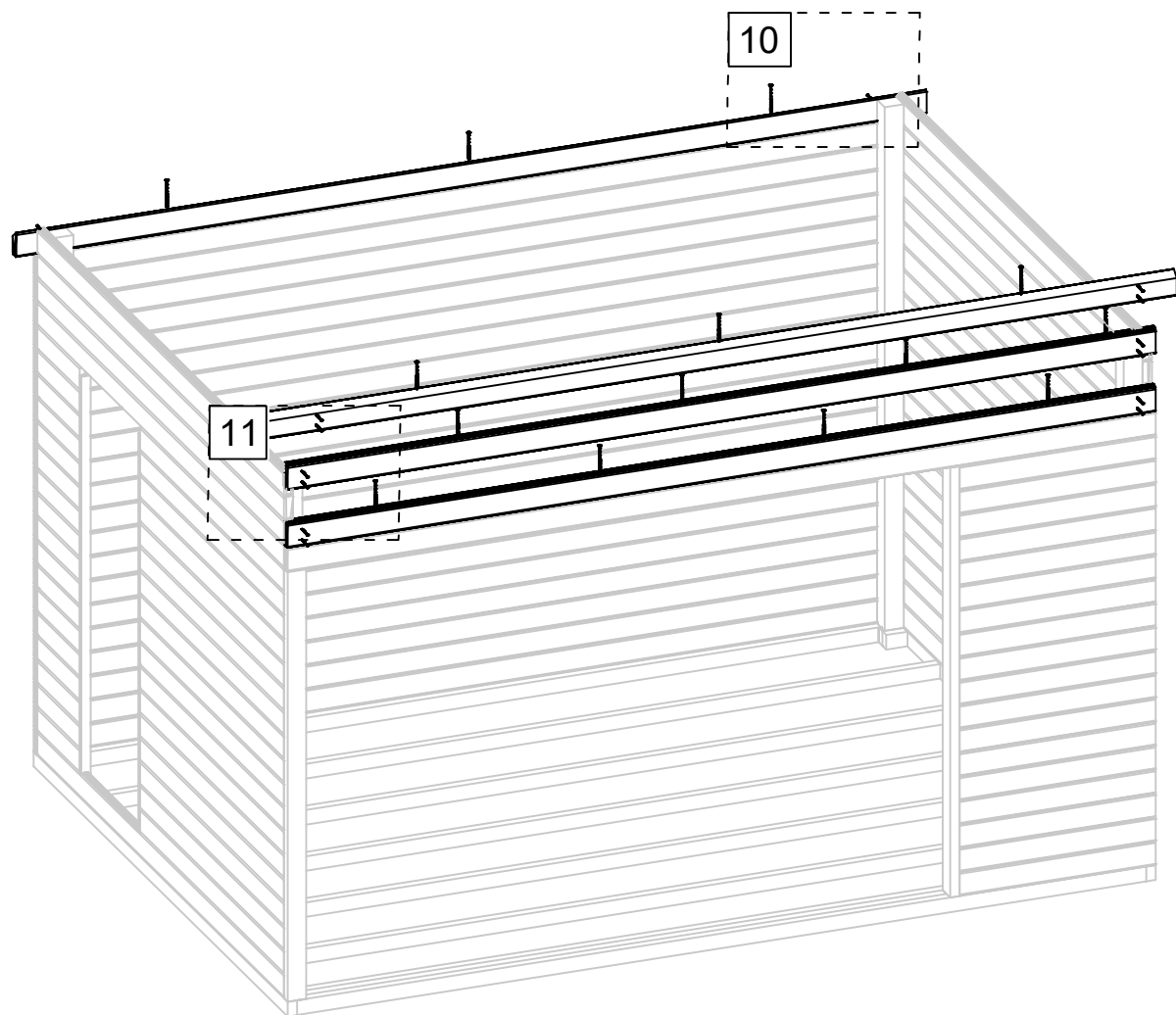

10

HS23

HS34

11

HS23

HS34

18.04.2023

15/23

Art. Nr. 4429719

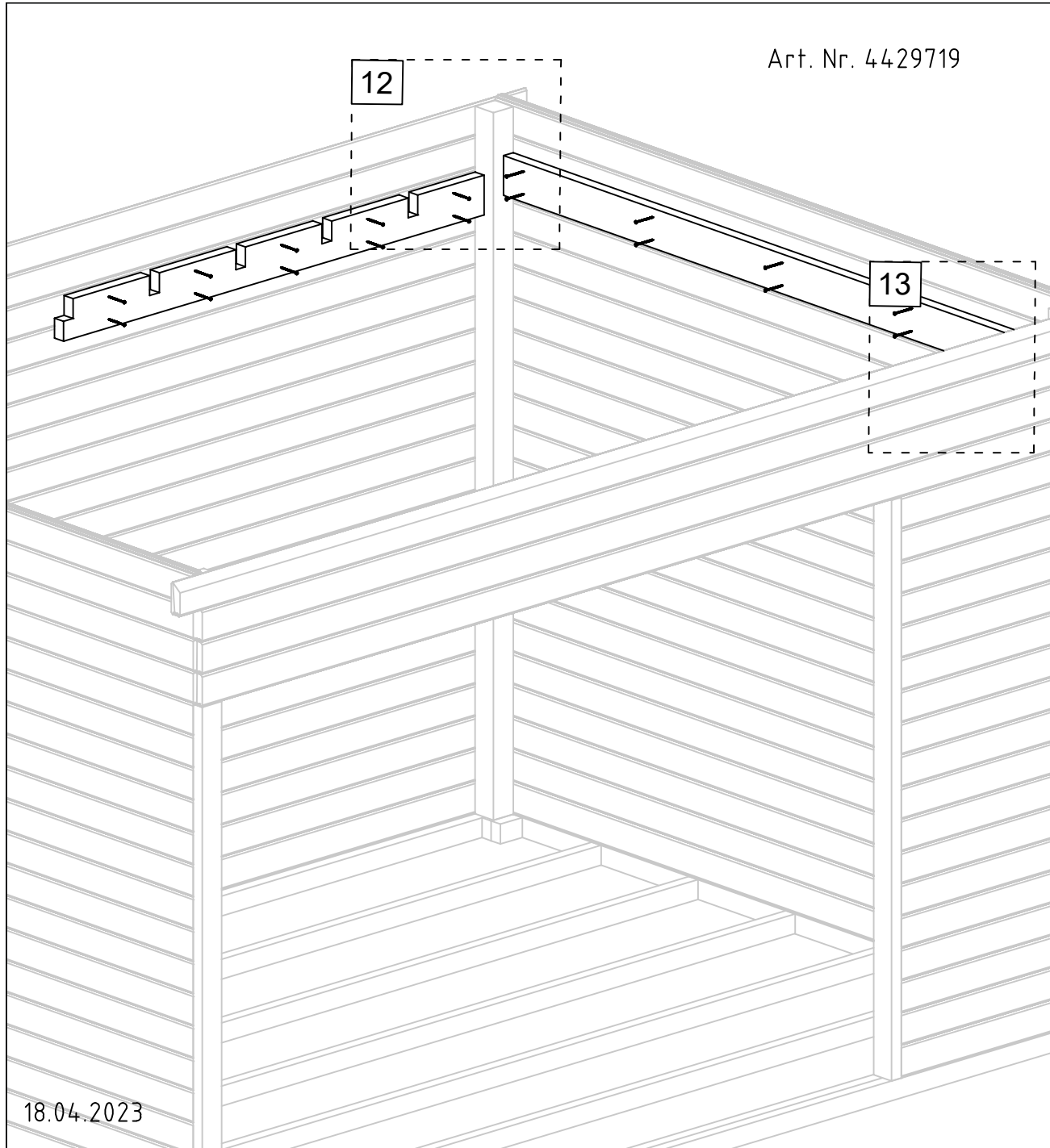

12

VT4

VT3

HS21

2127 mm

2197 mm

13

VT4

VT3

HS21

Art. Nr. 4429719

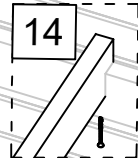
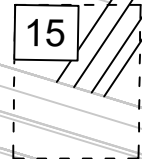

14

VT1



HS18

15

VT2

VT1

HS34

18.04.2023

17/23

Art. Nr. 4429719

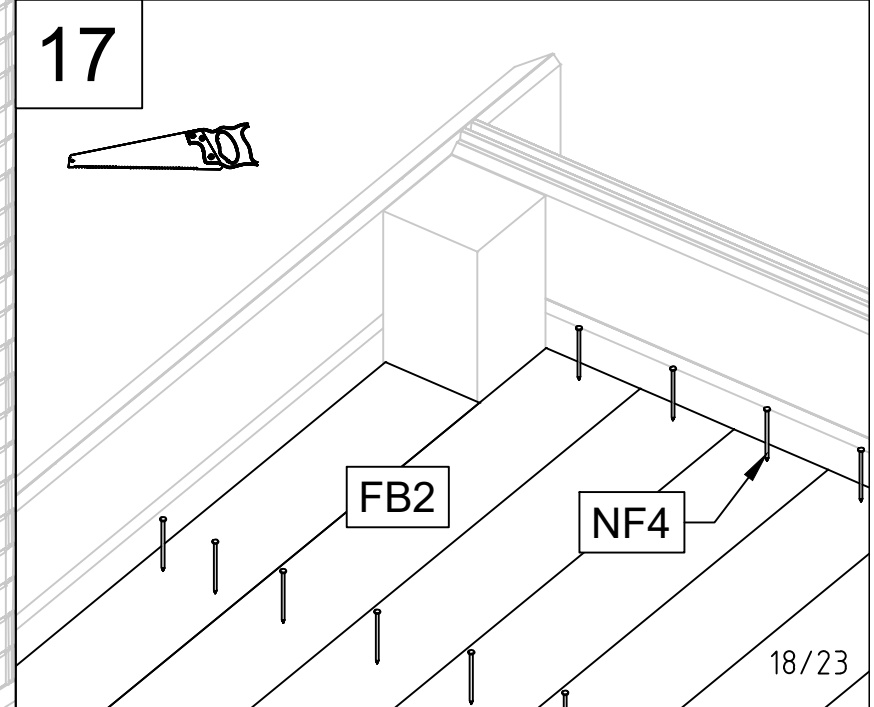
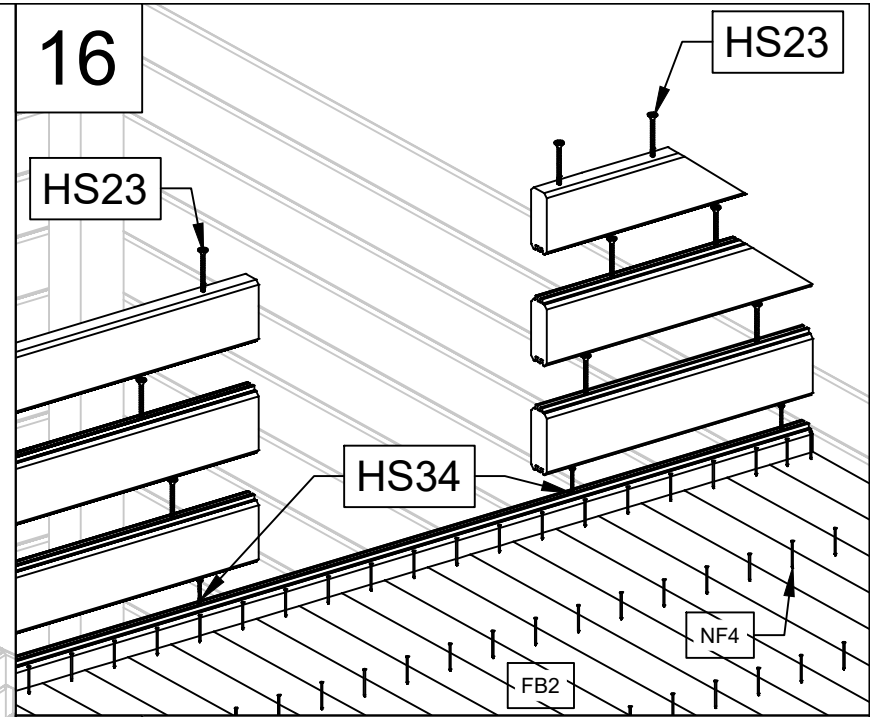
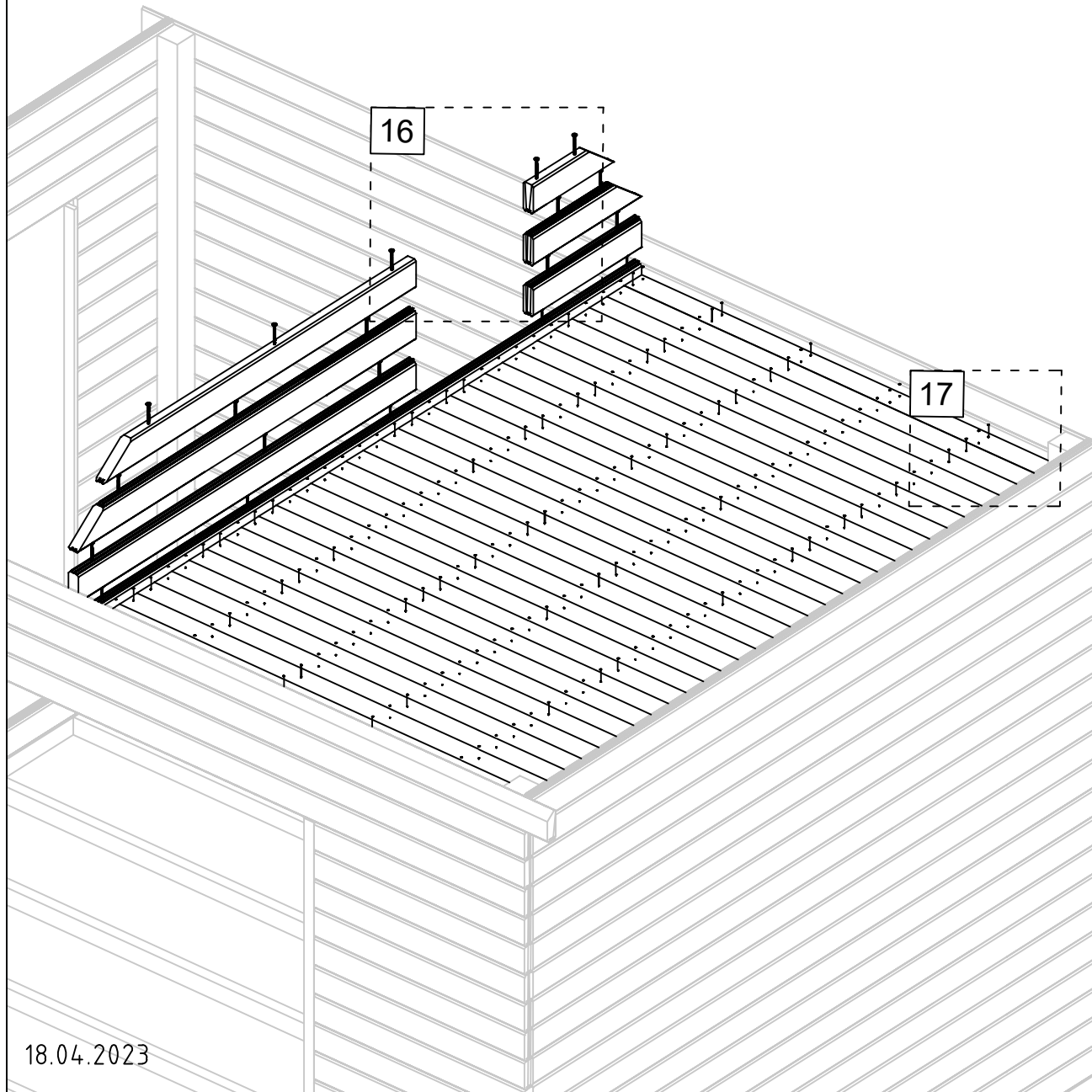

Art. Nr. 4429719

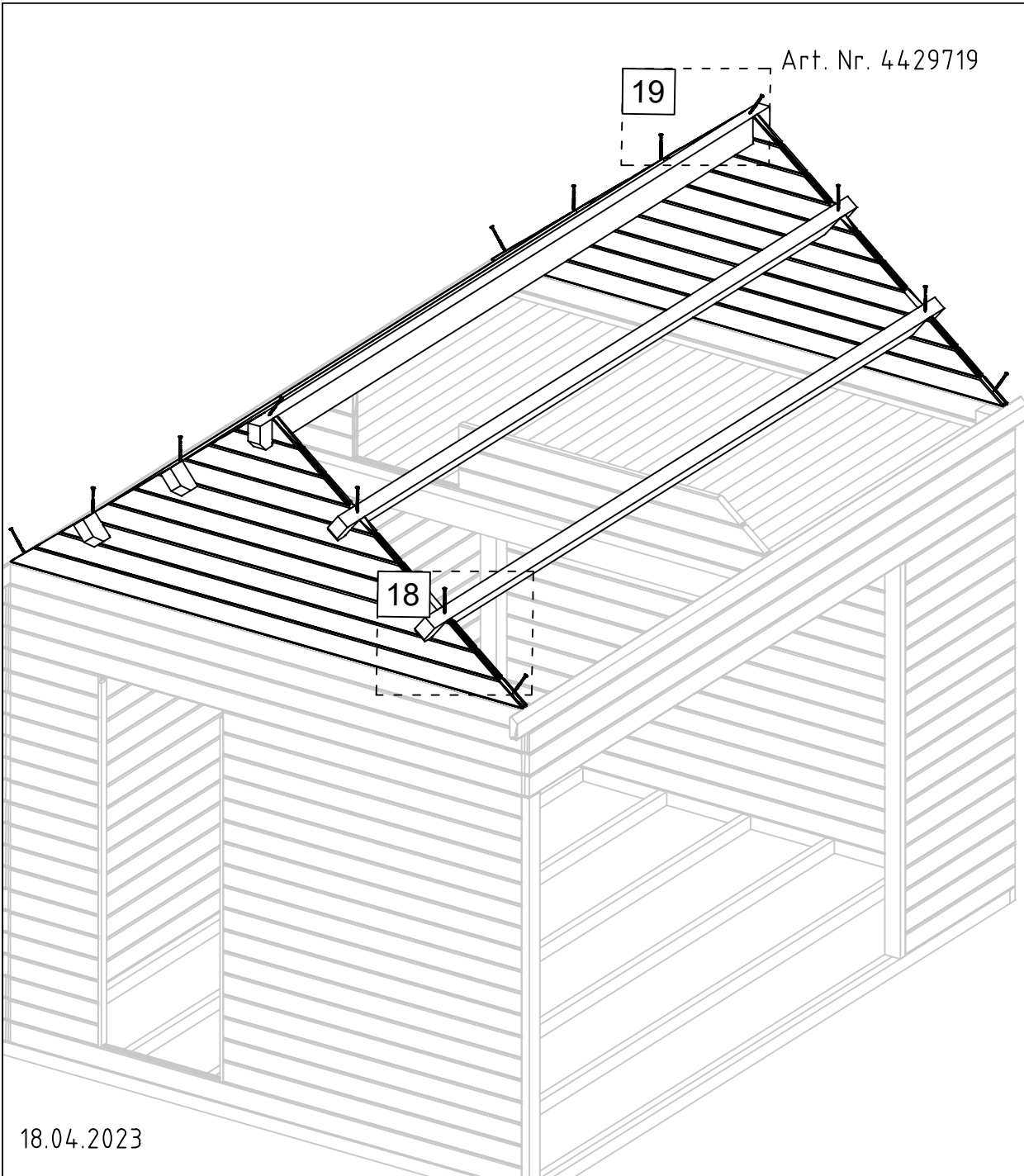

18.04.2023

18

HS18

APR

HS18

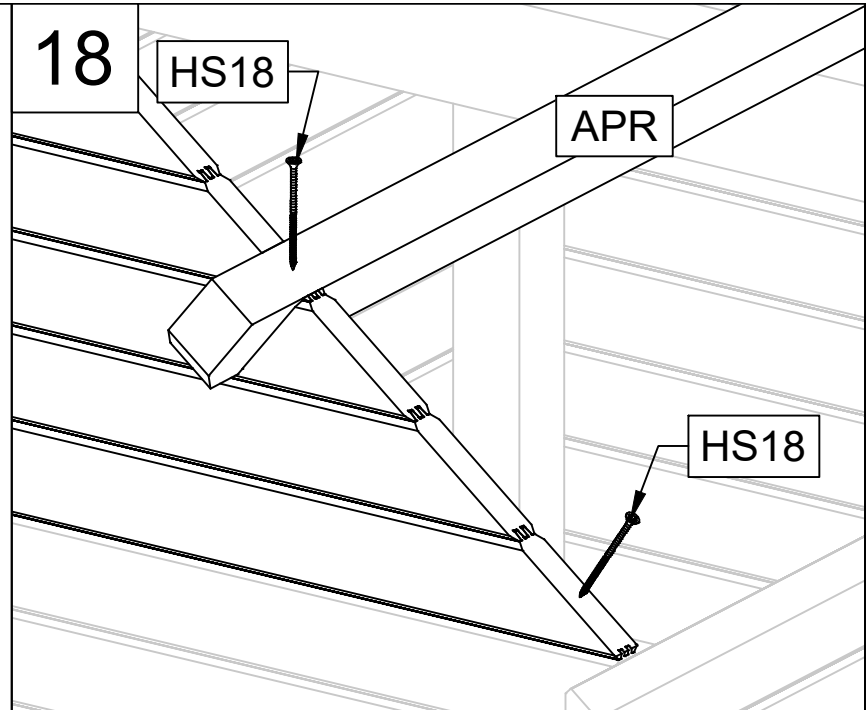

19

HS18

HS18

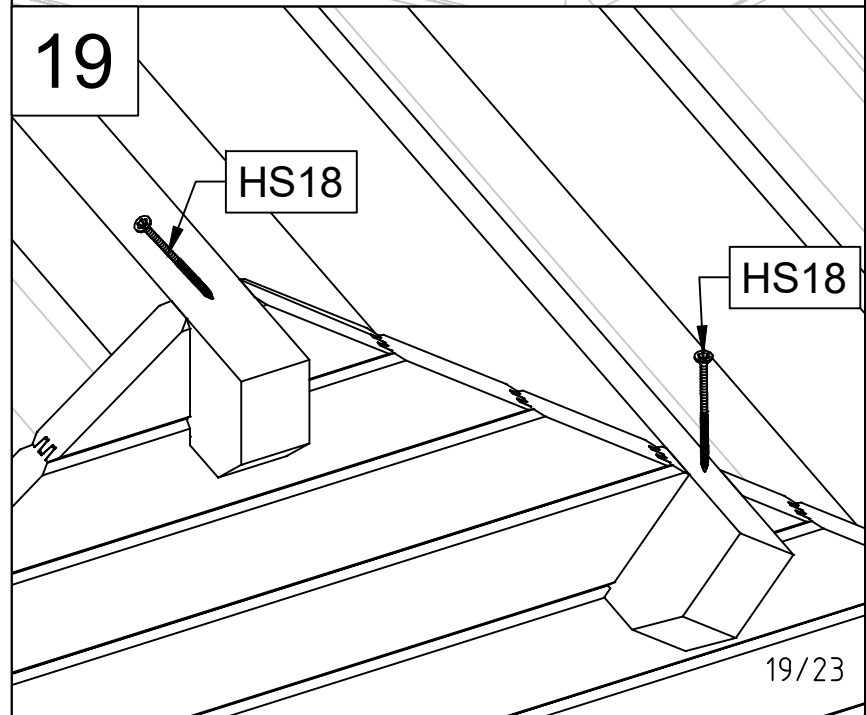

19/23

Art. Nr. 4429719

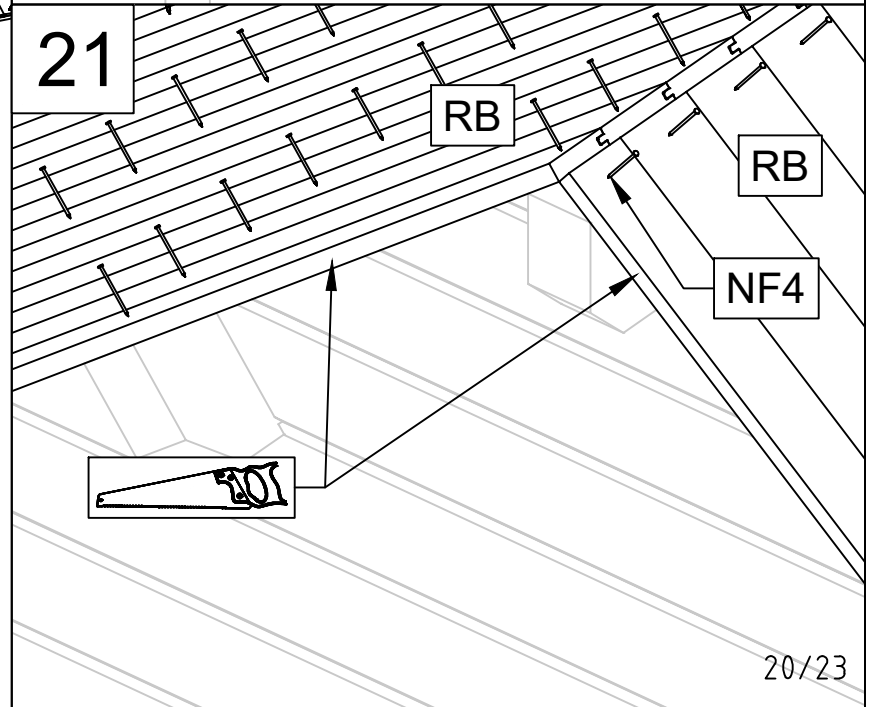
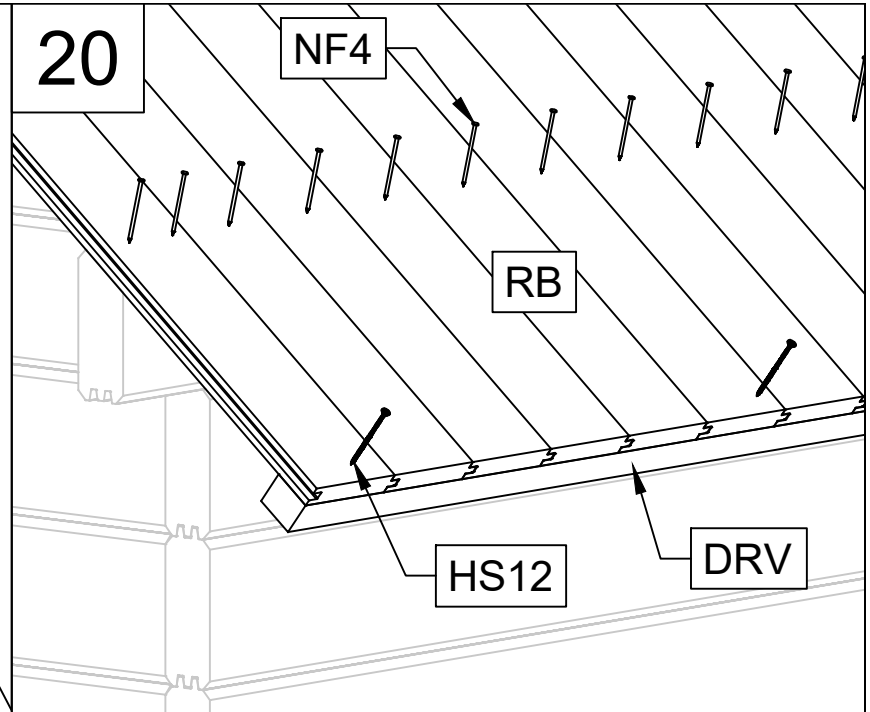
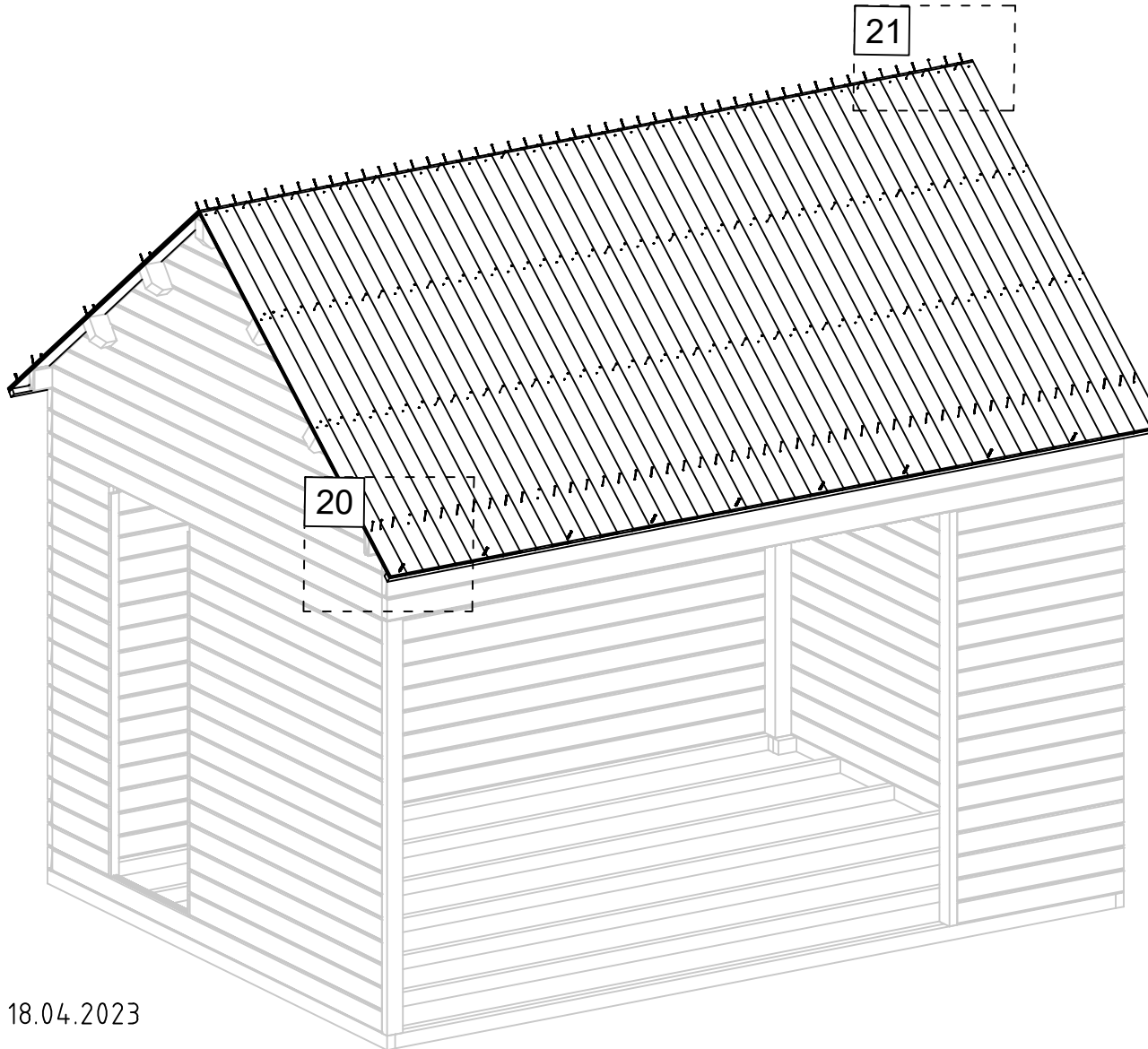

Art. Nr. 4429719

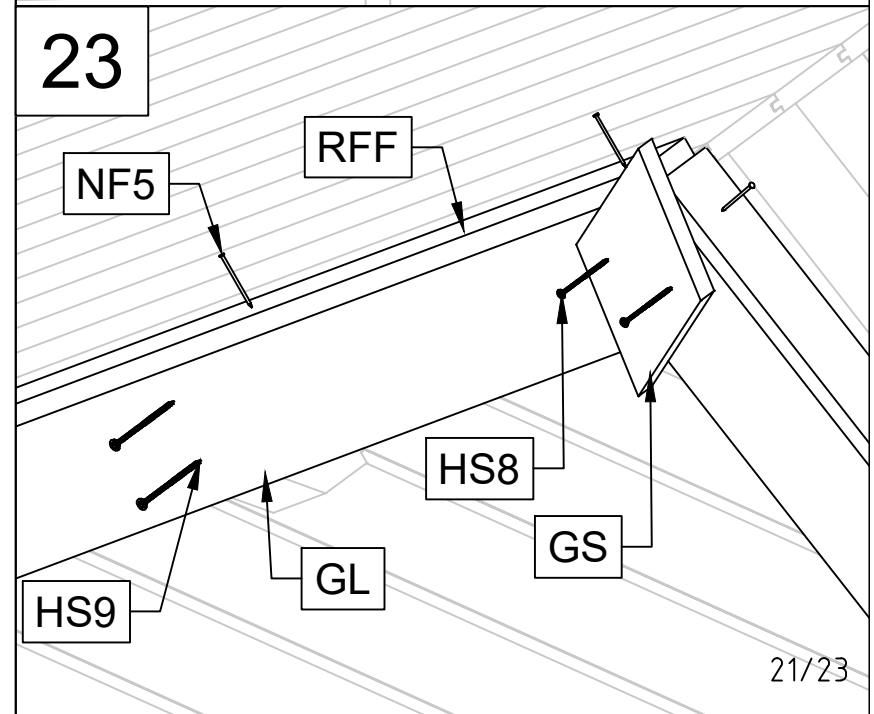
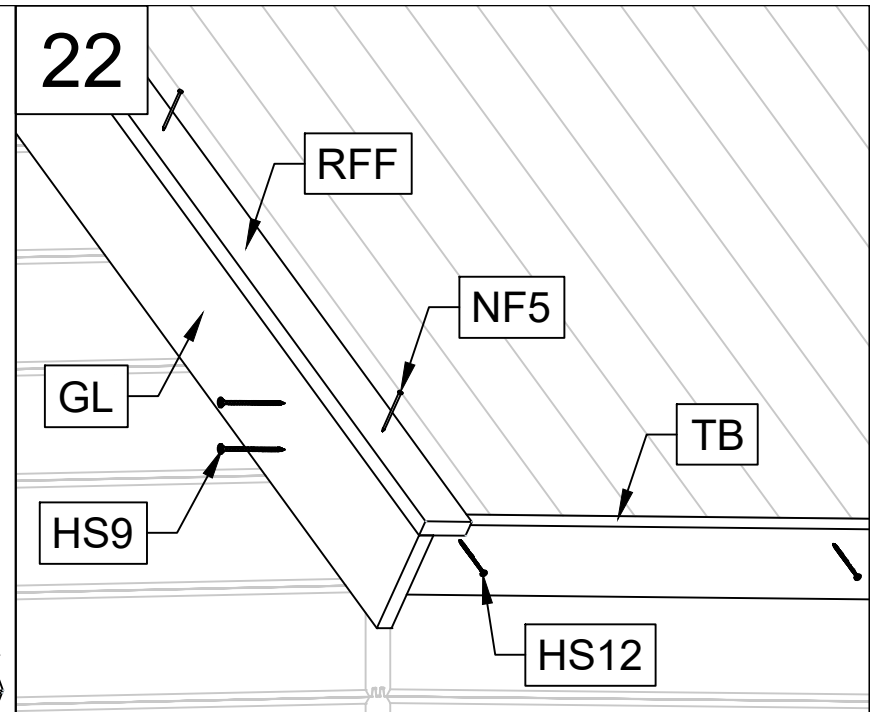
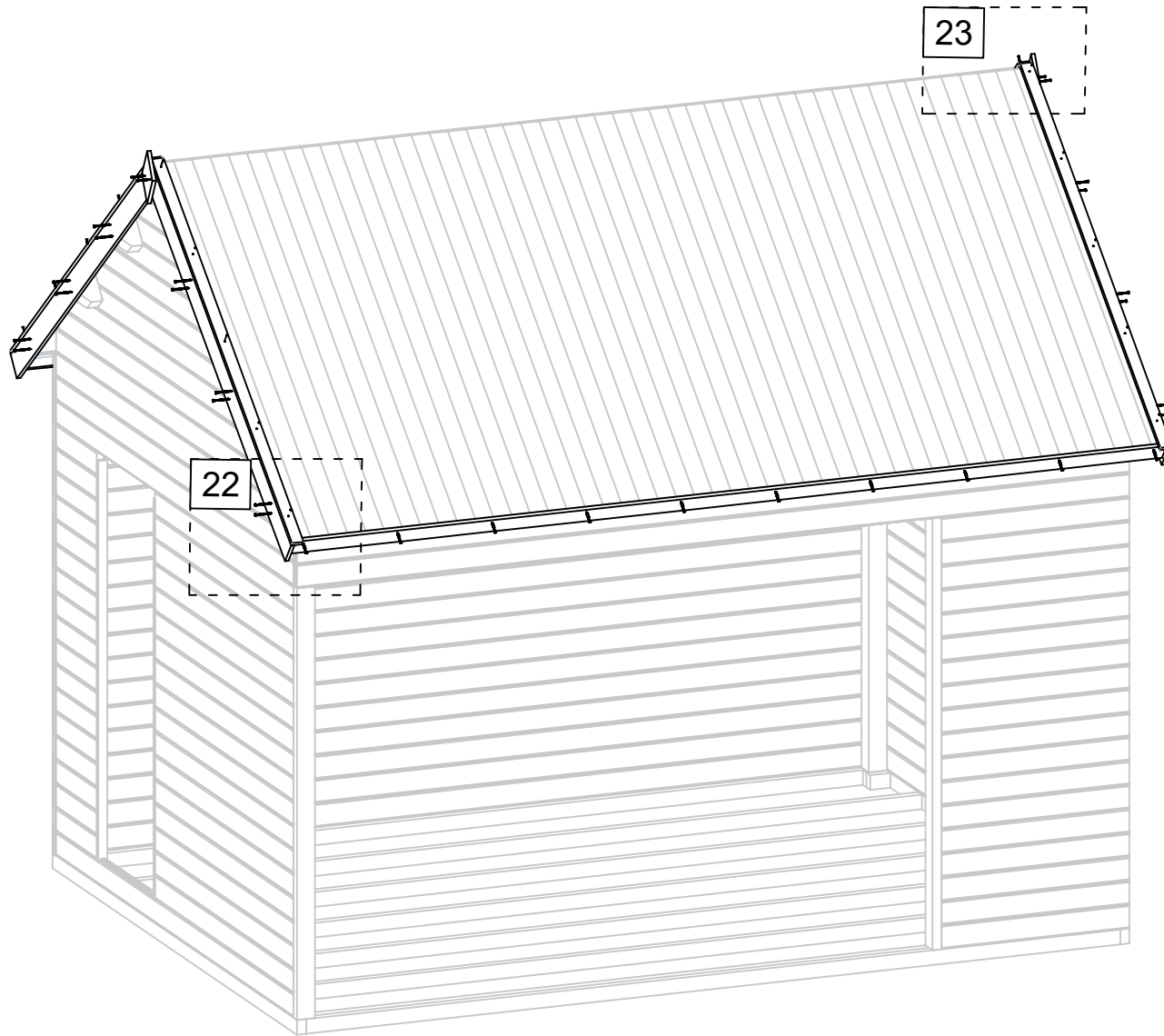

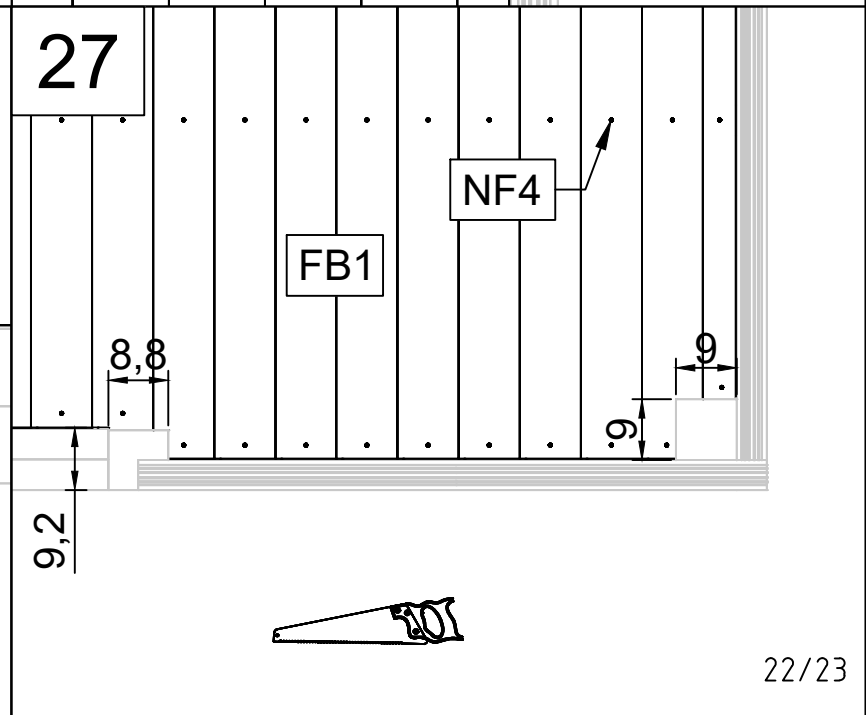
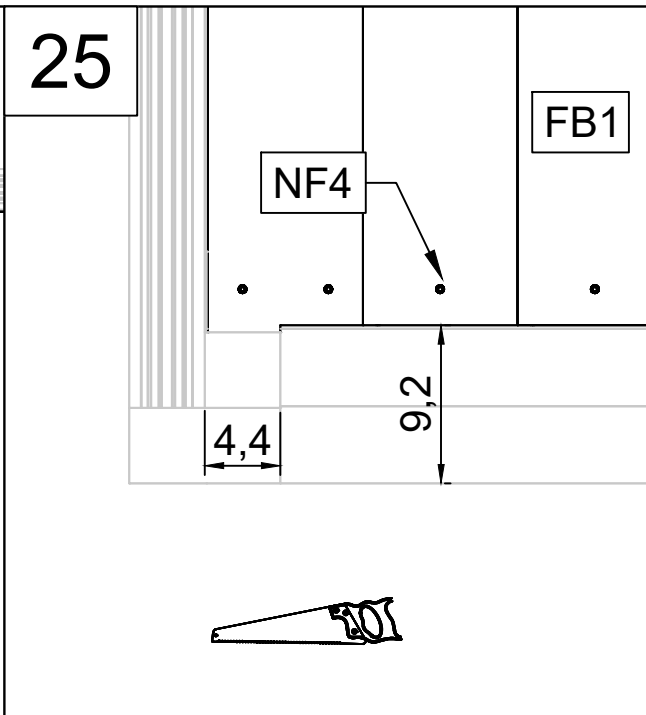
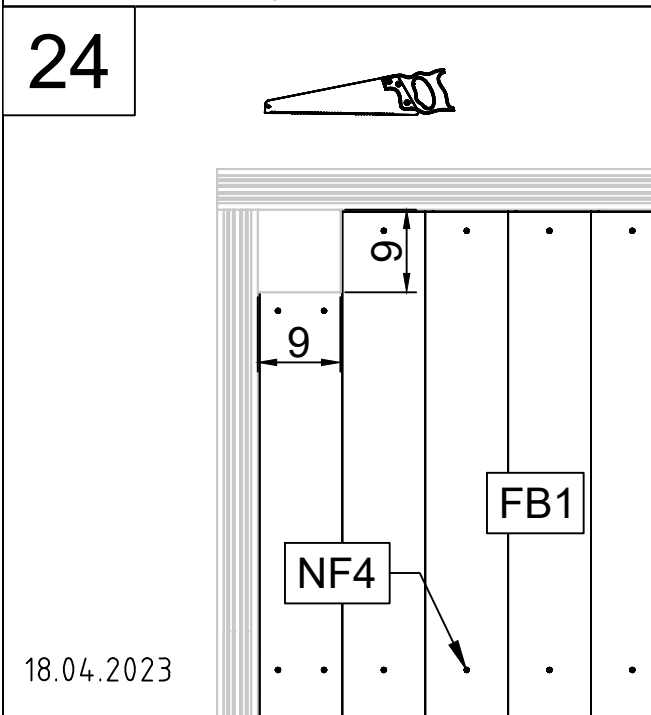
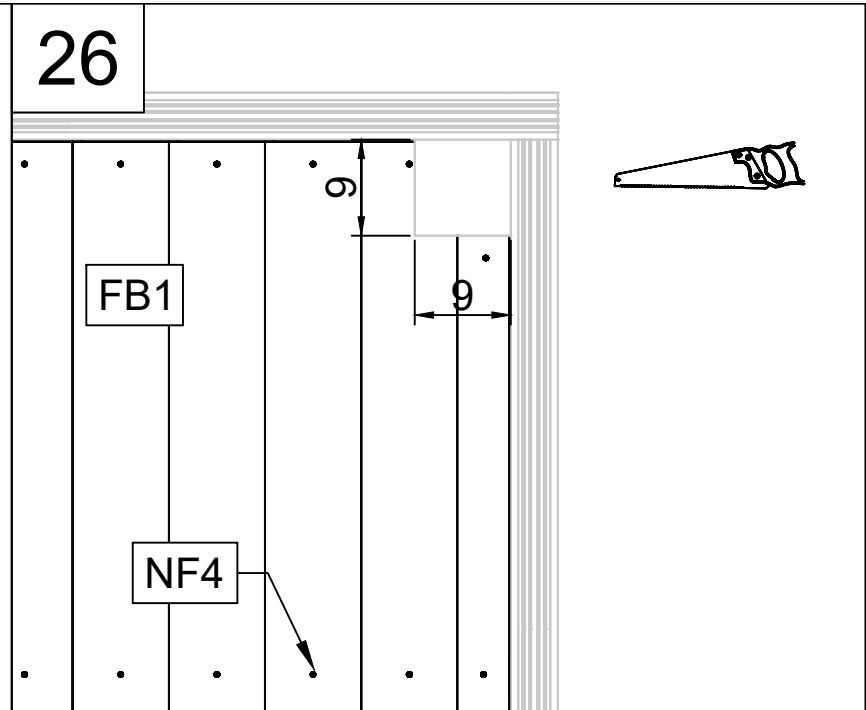
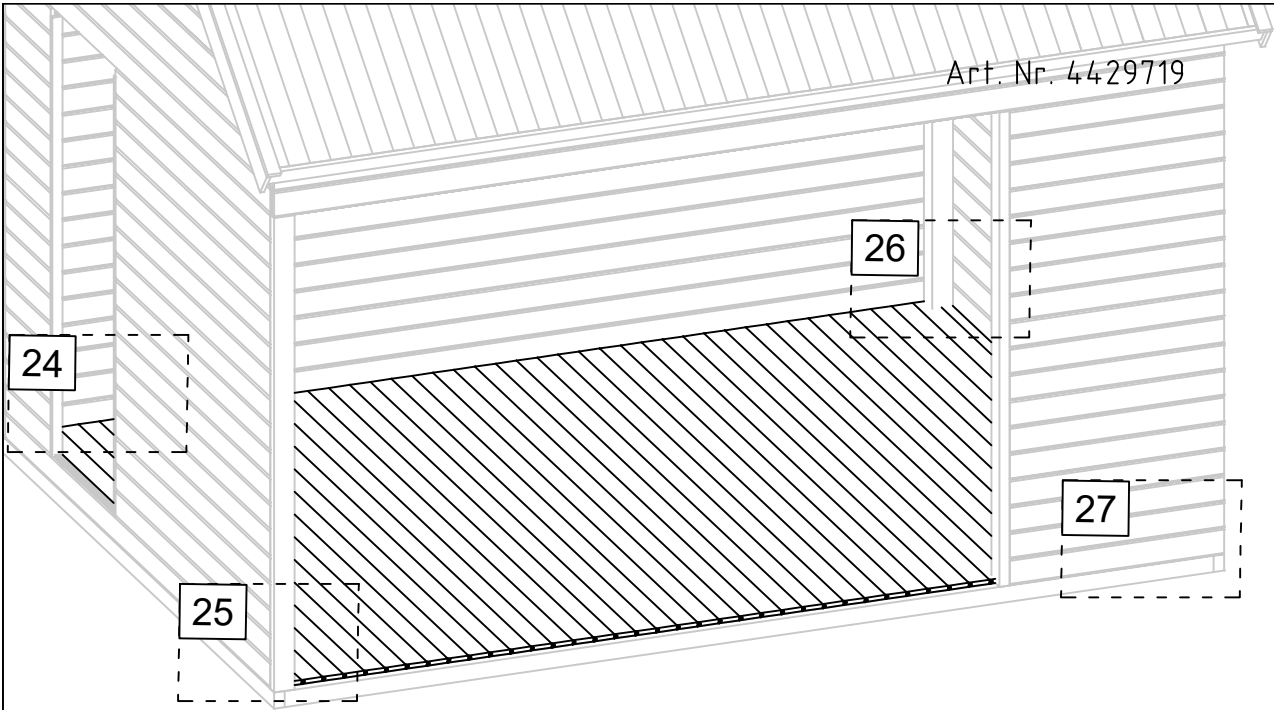

Art. Nr. 4429719

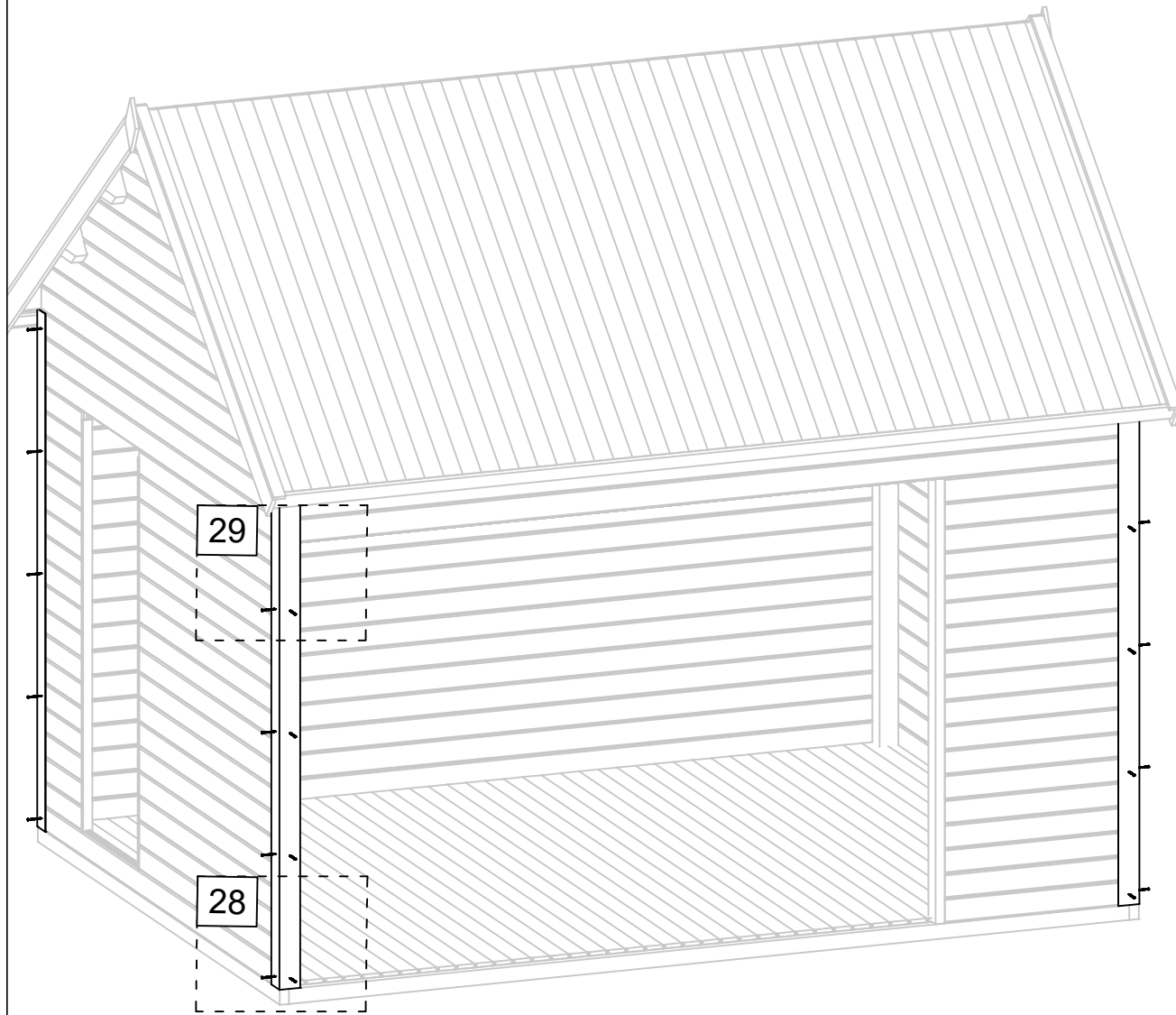

28

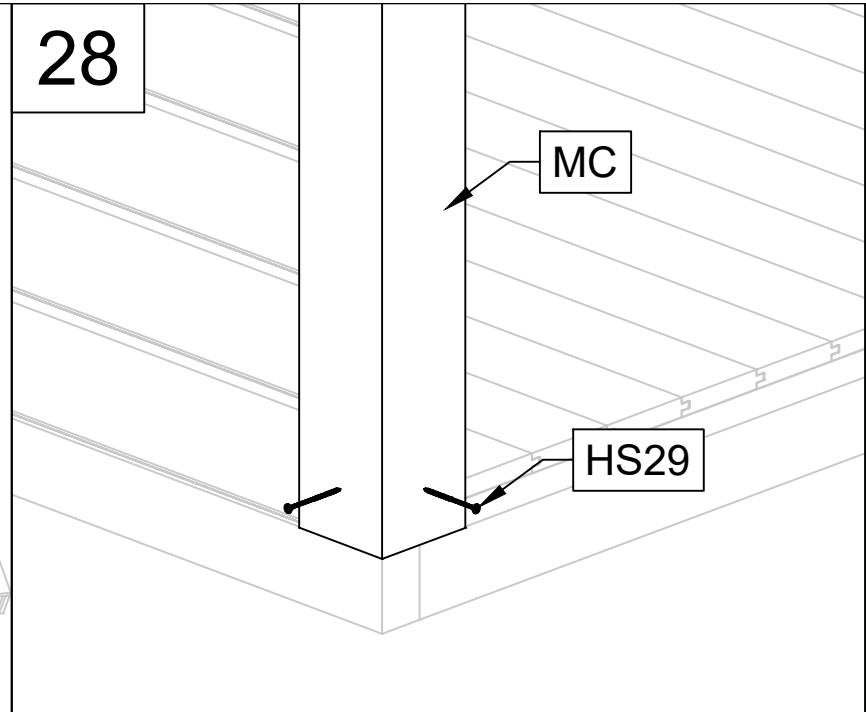

MC

HS29

29

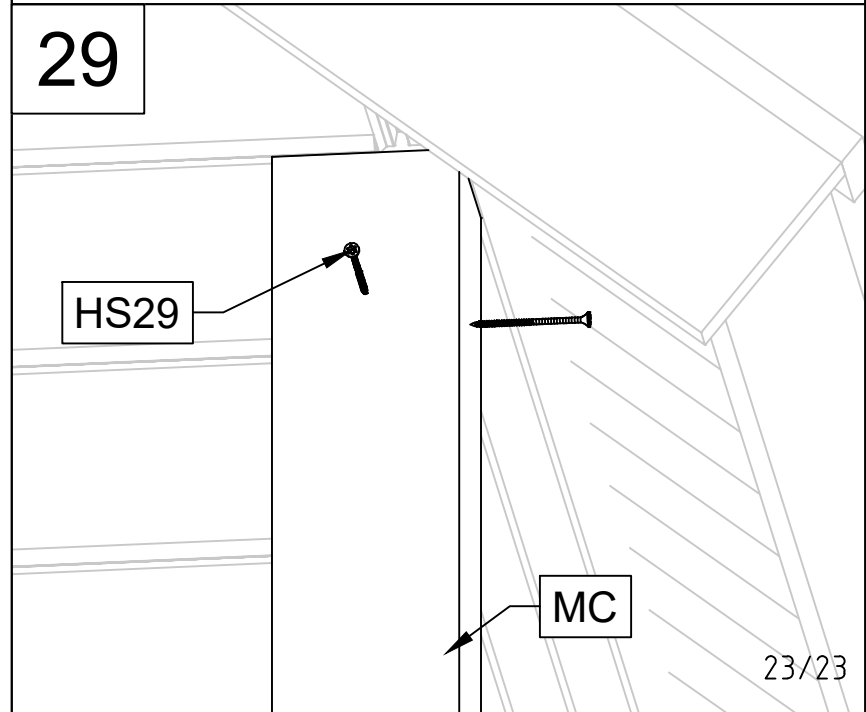

HS29

MC