

Name

VS44\_0066 400x598\_44

Zeichnung/Drawing

3D

Maßstab/Scale 1:40

Profil/Profile 4.4x13.5

Druck auf/  
Print on A4

Datum/Date 25.08.2023

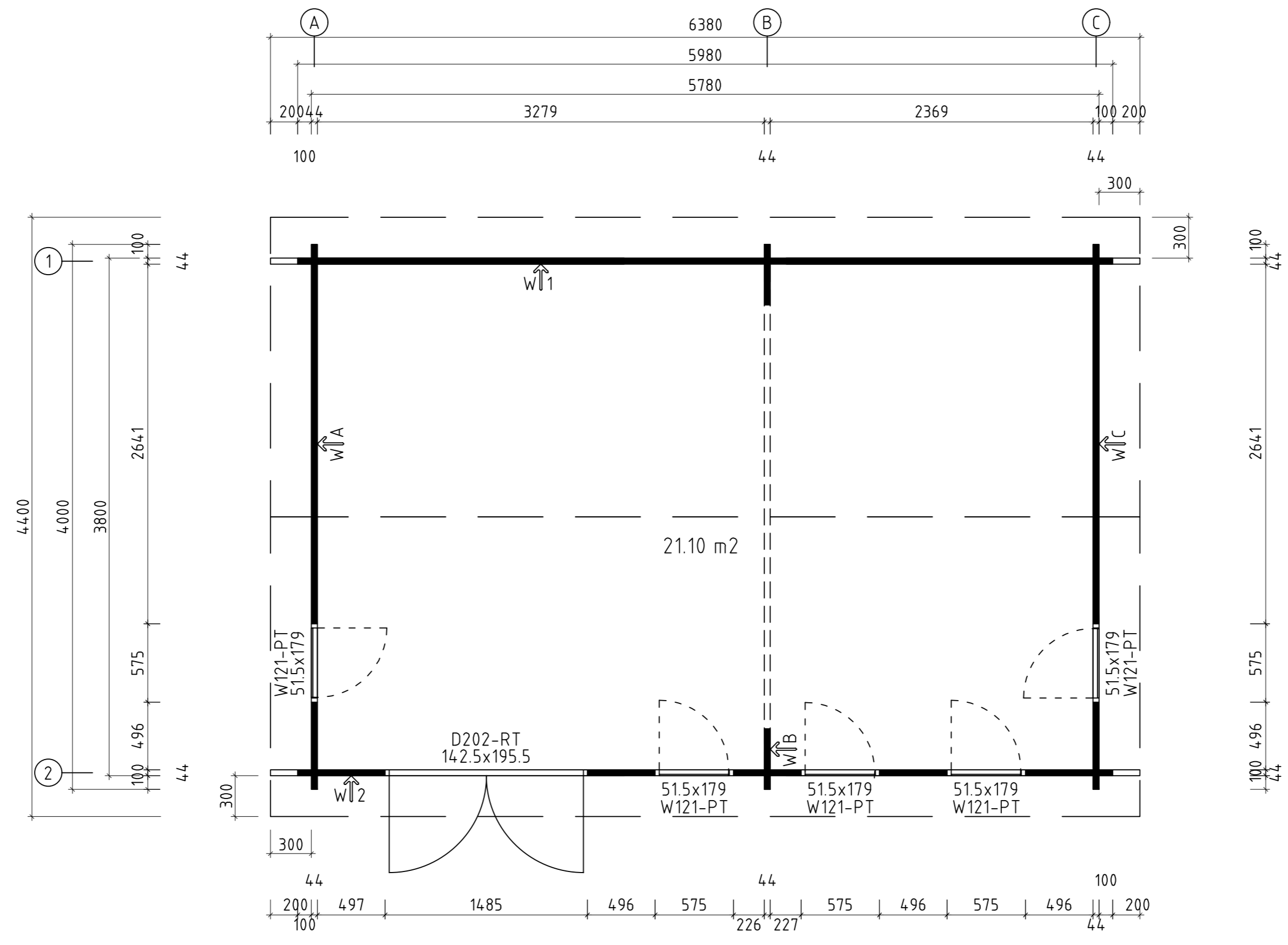

\* Fenster und Türen sind ohne Sprossen  
 Windows and doors are without muntins



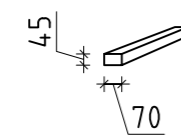
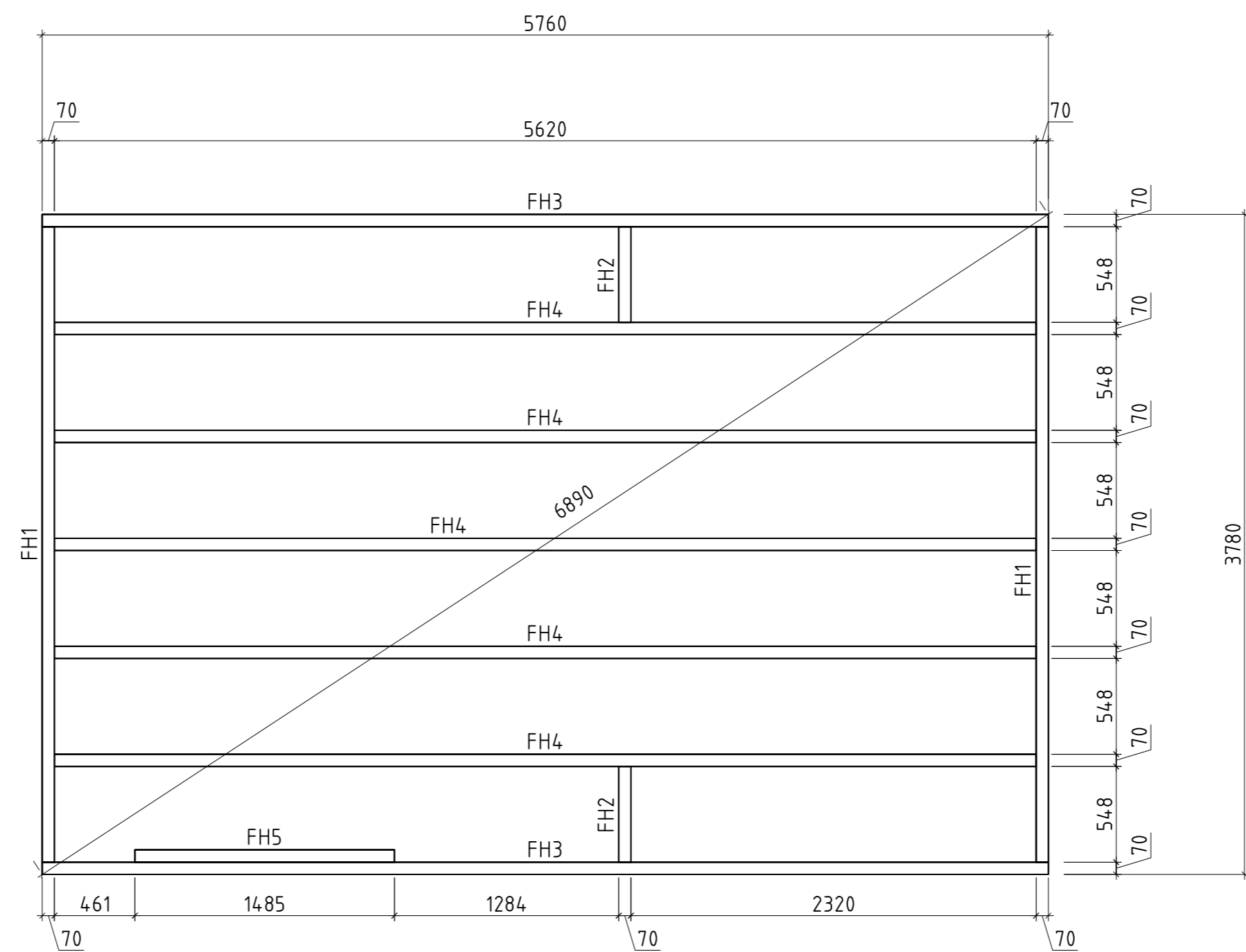

Q4 – Qualitätsklasse für Fenster und Türen/  
 Quality class for windows and doors



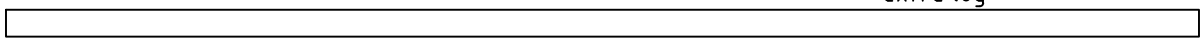
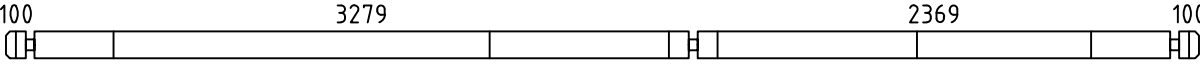
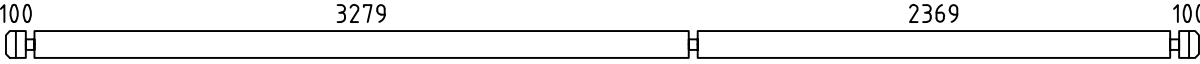
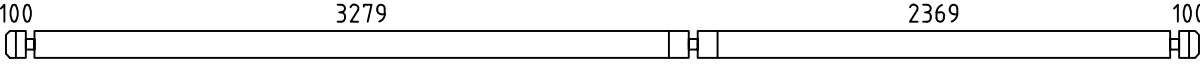
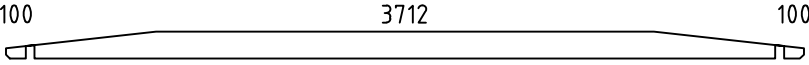
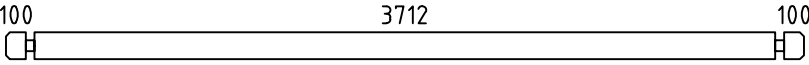
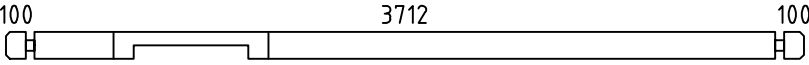
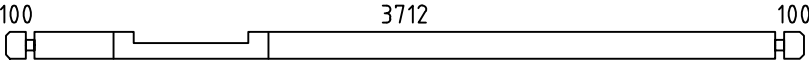
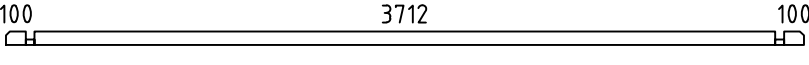
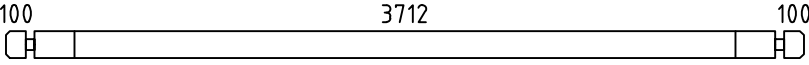
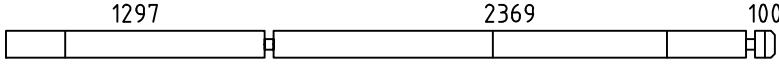
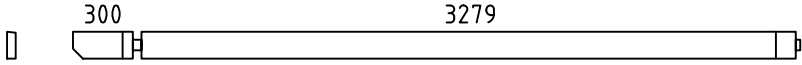
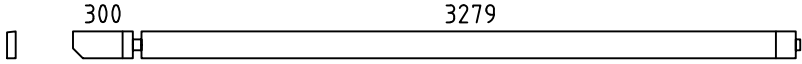
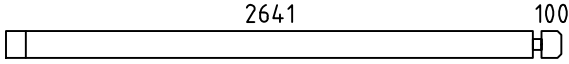
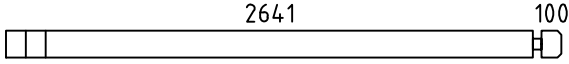
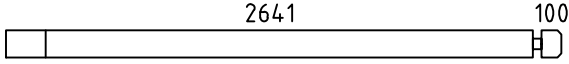
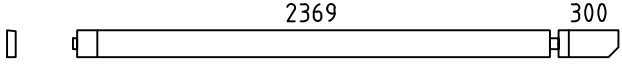
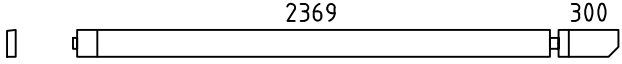
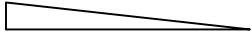
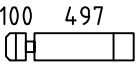
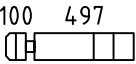
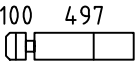
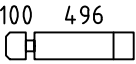
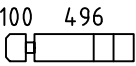
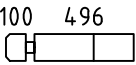
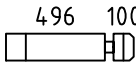

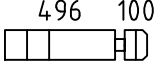
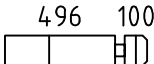
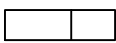
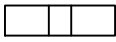
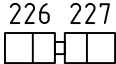
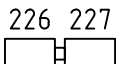
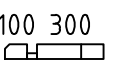
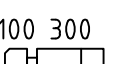
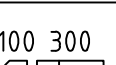
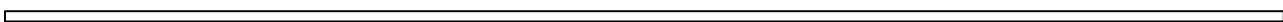
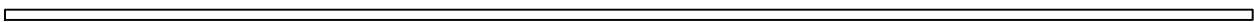
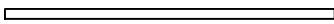
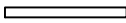
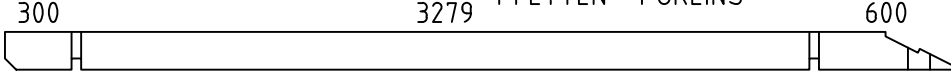
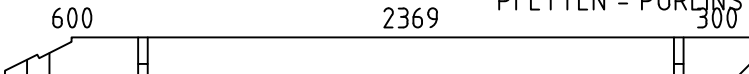
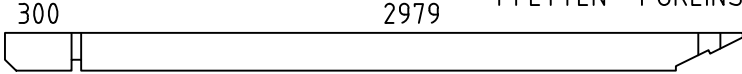
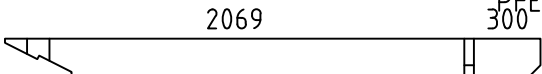
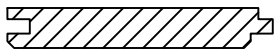
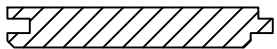



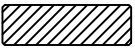

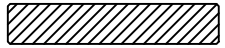

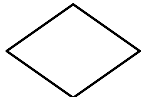
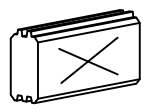
Name	VS44_0066 400x598_44				
Zeichnung/Drawing	Grundplan_Plan				
Maßstab/Scale	1:40	Profil/Profile	4.4x13.5	Druck auf/Print on	A3
				Datum/Date	25.08.2023

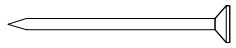
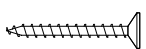

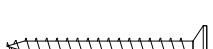
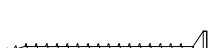
Name	VS44_0066 400x598_44		
Zeichnung/Drawing	Lagerholzplan_Foundation beams		
Maßstab/Scale	1:40	Profil/Profile	4.4x13.5
		Druck auf/Print on	A3
		Datum/Date	25.08.2023

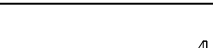
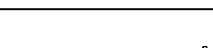
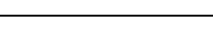
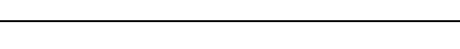
Pos	Teieliste/Specification VS44_0066 400x598_44	Stck Pcs.	Profil Profile (mm)	Länge Length (mm)
	Achtung! Die Giebelbohlen können teilweise schon vormontiert sein! Bitte beachten - diese erscheinen nicht ganz so wie in der Teieliste beschrieben.			
	Notice! The gable pieces can be partly pre-assembled! Please notice - those differ from the description given in the specification list.			
000	 extra log	1	44x135	5980
001		1	44x135	5980
002		14	44x135	5980
003		2	44x135	5980
004		3	44x135	4000
005		2	44x135	4000
006		2	44x135	4000
007		2	44x135	4000
008		2	44x68	4000
009		1	44x135	4000
010		1	44x135	3854
011		1	44x135	3645
012		1	44x135	3645
013		12	44x135	2785
014		8	44x135	2785
015		6	44x135	2785
016		1	44x135	2735
017		1	44x135	2735
018		6	44x135	1223
019		9	44x135	641
020		4	44x135	641
021		2	44x135	641
022		12	44x135	640
023		8	44x135	640
024		6	44x135	640
025		8	44x135	640
Kood	VS44_0066 400x598_44	Materjal		Leht 1/4

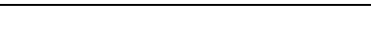
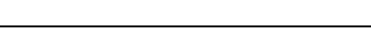
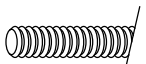
Pos	Teileliste/Specification VS44_0066 400x598_44	Stck Pcs.	Profil Profile (mm)	Länge Length (mm)
026		4	44x135	640
027		2	44x135	640
028		20	44x135	496
029		8	44x135	496
030		1	44x135	496
031		13	44x135	496
032		2	44x68	444
033		16	44x135	444
034		8	44x135	444
035		6	44x135	444
FH3	FUNDAMENTHOLZ (imprägniert) - FOUNDATION BEAM (impregnated) 	2	70x45	5760
FH4	FUNDAMENTHOLZ (imprägniert) - FOUNDATION BEAM (impregnated) 	5	70x45	5620
FH1	FUNDAMENTHOLZ (imprägniert) - FOUNDATION BEAM (impregnated) 	2	70x45	3640
FH5	FUNDAMENTHOLZ (imprägniert) - FOUNDATION BEAM (impregnated) 	1	70x45	1485
FH2	FUNDAMENTHOLZ (imprägniert) - FOUNDATION BEAM (impregnated) 	2	70x45	548
PF3	300 3279 PFETTEN - PURLINS 600 	2	58x170	4267
PF2	600 2369 PFETTEN - PURLINS 300 	3	58x170	3357
PF1	300 2979 PFETTEN - PURLINS 	3	58x170	3323
PF4	2069 PFETTEN - PURLINS 300 	2	58x170	2413
	DACHBRETTER - ROOF BOARDS 	114+2	113x18	2213
	FUSSBODENBRETTER - FLOOR BOARDS 	51+1	113x18	3707
	DECKENLEISTEN - CEILING STRIPS  ✓		15x28	35.0 lfm/rm
	FUSSBODENLEISTEN - FLOOR STRIPS  ✓		18x40	21.0 lfm/rm
G02-1	GIEBELBRETTER - GABLE BOARDS 18x120 6.3°  ✓	4	18x120	2294
G06-1	GIEBELDECKLEISTEN - GABLE COVER STRIPS 18x58  ✓	4	18x58	2294
Kood	VS44_0066 400x598_44	Materjal		Leht 2/4

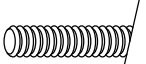
Pos	Teileliste/Specification VS44_0066 400x598_44		Stck Pcs.	Profil Profile (mm)	Länge Length (mm)
T01-1	TRAUFENBRETTER - EAVES BOARDS 18x95		4	18x95	3190
T06-1	TRAUFENLEISTEN - EAVES STRIPS 18x40		4	18x40	3190
GS	GIEBELSEGMENT - GABLE DIAMOND		2		
SH	SCHLAGHÖLZER - MOUNTING PIECES		3		
VS	Verbindungsstreifen für verbinden der Wandbohlen - Connecting strip for connecting the wall parts		2		
NG2 550	NÄGEL - NAILS 2.5x50 Dachbretter - Roof boards		912		
NG2 550	NÄGEL - NAILS 2.5x50 Fussbodenbretter - Floor boards		714		
SR3 030	Schrauben - Screws 3.0x30 Deckenleisten - Ceiling strips		72		
SR3 030	Schrauben - Screws 3.0x30 Fussbodenleisten - Floor strips		42		
SR3 030	Schrauben - Screws 3.0x30 Traufenleisten - Eaves strips		28		
SR3 545	Schrauben - Screws 3.5x45 Giebelbretter - Gable boards		24		
SR3 545	Schrauben - Screws 3.5x45 Giebeldeckleisten - Gable cover strips		24		
SR3 545	Schrauben - Screws 3.5x45 Giebelsegment - Gable diamond		4		
SR3 545	Schrauben - Screws 3.5x45 Traufenbretter - Eaves boards		28		
SR354 5-001	Schrauben - Screws 3.5x45 Verbindungsstreifen - Connecting strip		8		
SR35 45-01	Schrauben - Screws 3.5x45 Rahmleisten - Trims		144		
SR5 0100	Schrauben - Screws 5.0x100 Fundamenthölzer - Foundation beams		48		
ML1	Metallstange - Metal bar		16	D10	900
ML2	Metallstange - Metal bar		2	D10	830
ML3	Metallstange - Metal bar		12	D10	770
ML4	Metallstange - Metal bar		4	D10	360
KL-1	Gewindestange - Threaded rod M12- für die Pfetten - for purlins		10		170
MUT26	Mutter - Nut M12 U-Scheibe - Washer Ø30- für die Pfetten - for purlins		20		
KL1	Gewindestange - Threaded Rod M8		4		2000
KL2	Gewindestange - Threaded Rod M8		4		295
Kood	VS44_0066 400x598_44		Materjal		Leht 3/4

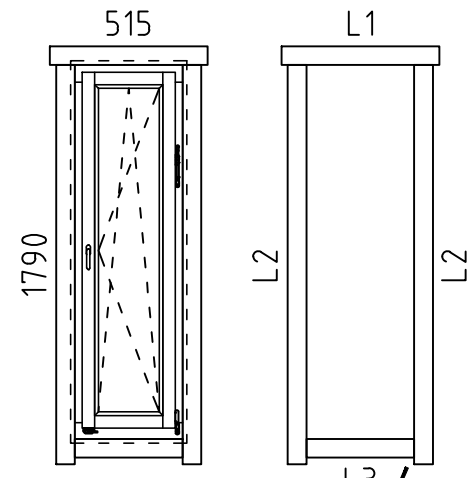
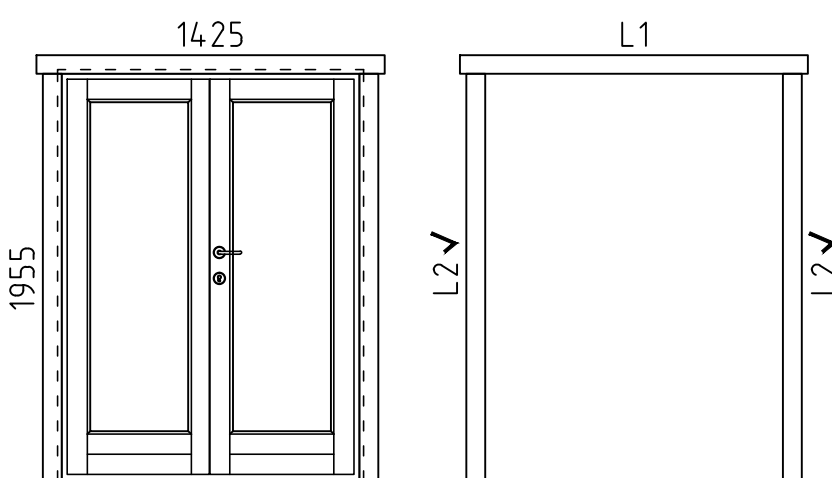
Pos	Teileliste/Specification VS44_0066 400x598_44	Stck Pcs.	Profil Profile (mm)	Länge Length (mm)
KV M UT M8	Mutter - Nut M8	8		
KV S EIB M8X25	U-Scheibe - Washer M8 Ø25	8		
KV MU TJ M8	Befestigungsmutter - Fixing nut M8	4		
	<p>FENSTER/WINDOW Q4 W4-S44P-0XT-05151790</p>  <p>W121-PT</p> <p>L1 18x90 L=755mm 2x L2 18x90 L=1910mm 4x L3 18x90 L=515mm 2x ✓</p> <p>DIN rechts; right handed</p>	5		
	<p>TÜR/DOOR Q4 D4-D44R-0XT-14251955</p>  <p>D202-RT</p> <p>L1 18x90 L=1665mm 2x L2 18x90 L=1955mm 4x ✓</p> <p>DIN rechts; right handed</p>	1		
	<p>✓ - Bitte selber anpassen (falls nötig)! / Cut into length on site (if needed)!</p>			
Kood	VS44_0066 400x598_44	Materjal	Leht	4/4

1

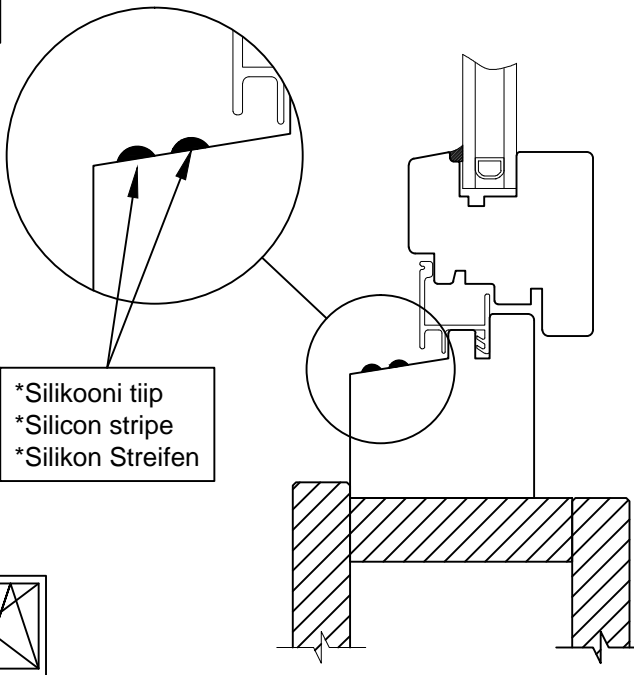

\*Silikooni tiip  
\*Silicon stripe  
\*Silikon Streifen

2

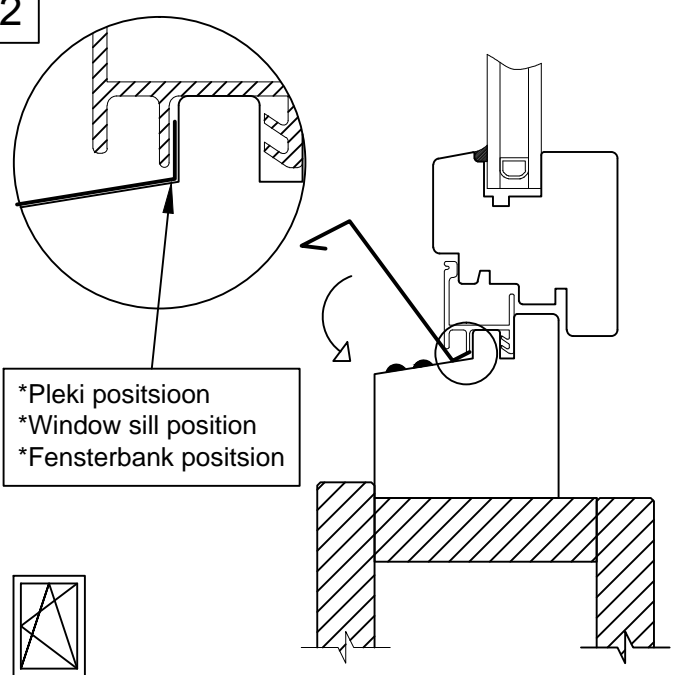

\*Pleki positsioon  
\*Window sill position  
\*Fensterbank position

3

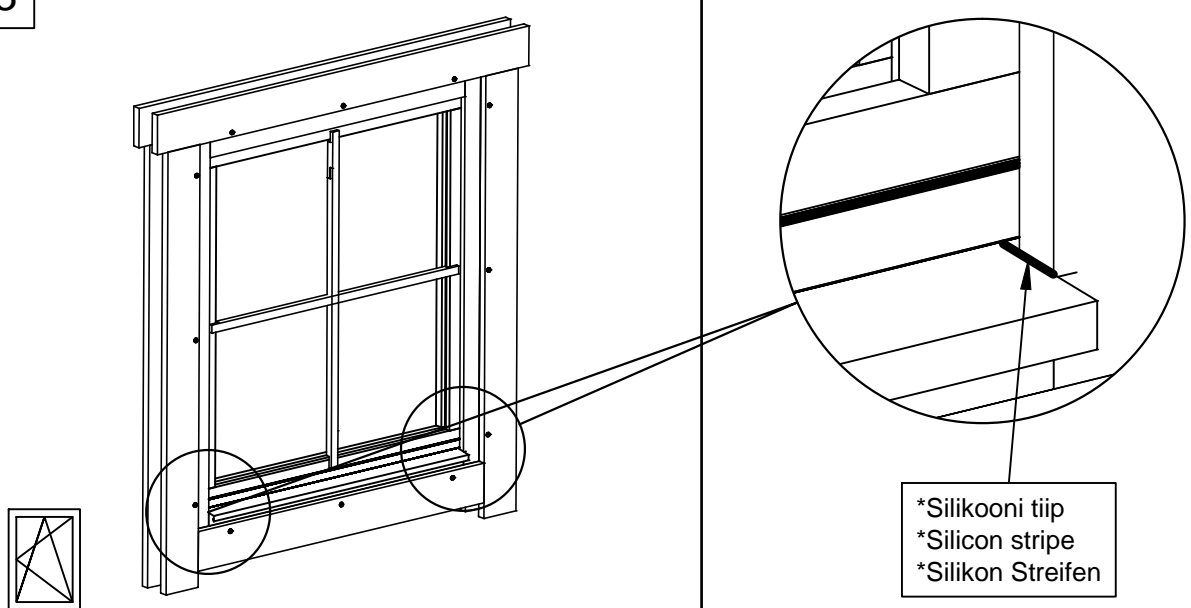

\*Silikooni tiip  
\*Silicon stripe  
\*Silikon Streifen

1

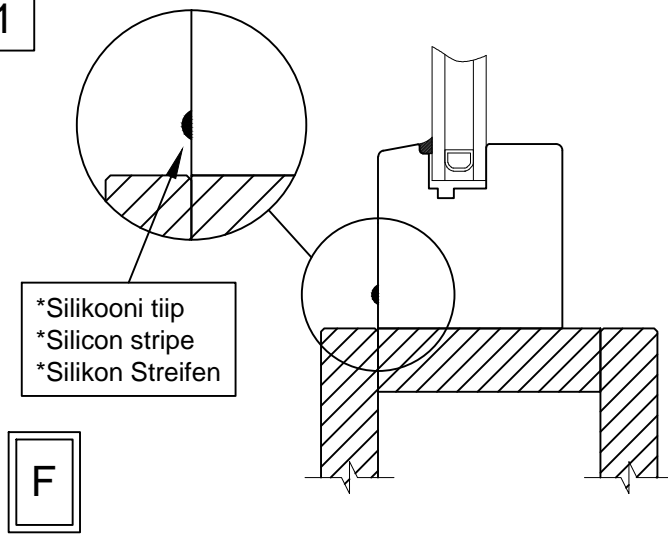

\*Silikooni tiip  
\*Silicon stripe  
\*Silikon Streifen

2

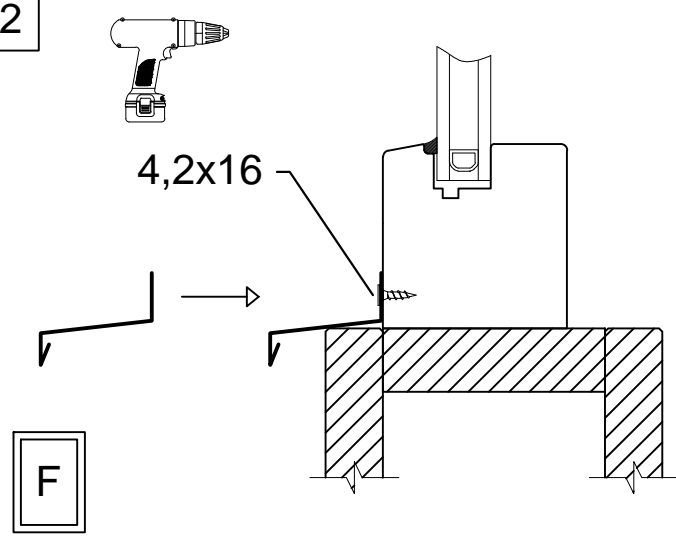

4,2x16



Aken	Q4-Q6	-	paigaldusjuhis
Window	Q4-Q6	-	assembly instructions
Fenster	Q4-Q6	-	Montageanleitung

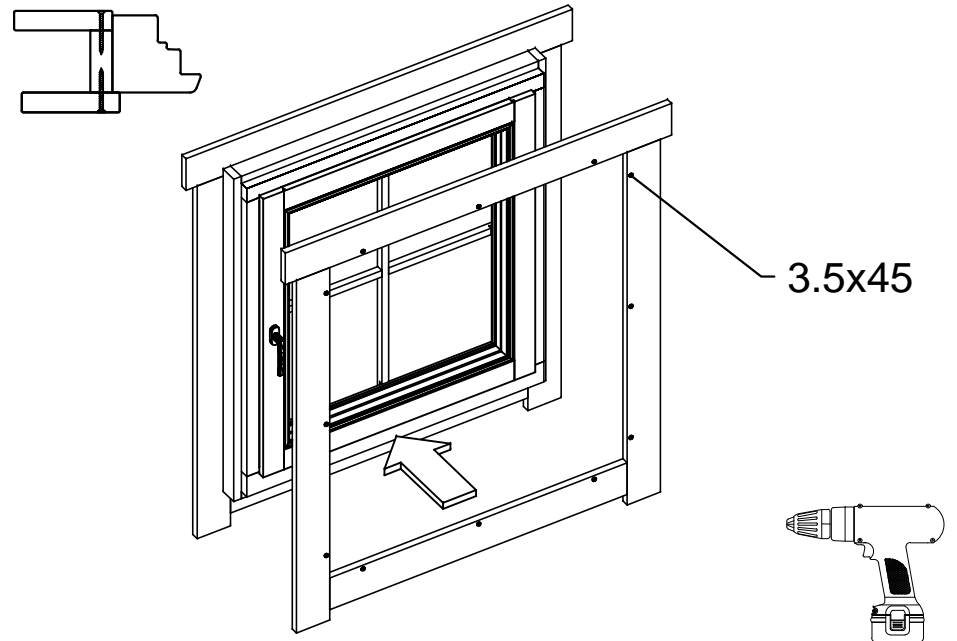
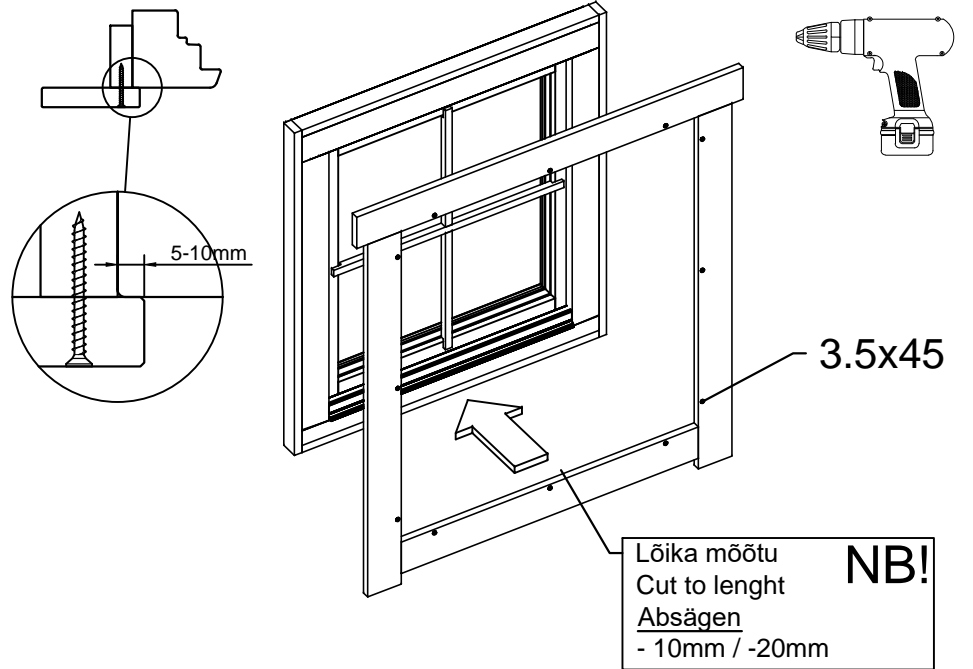
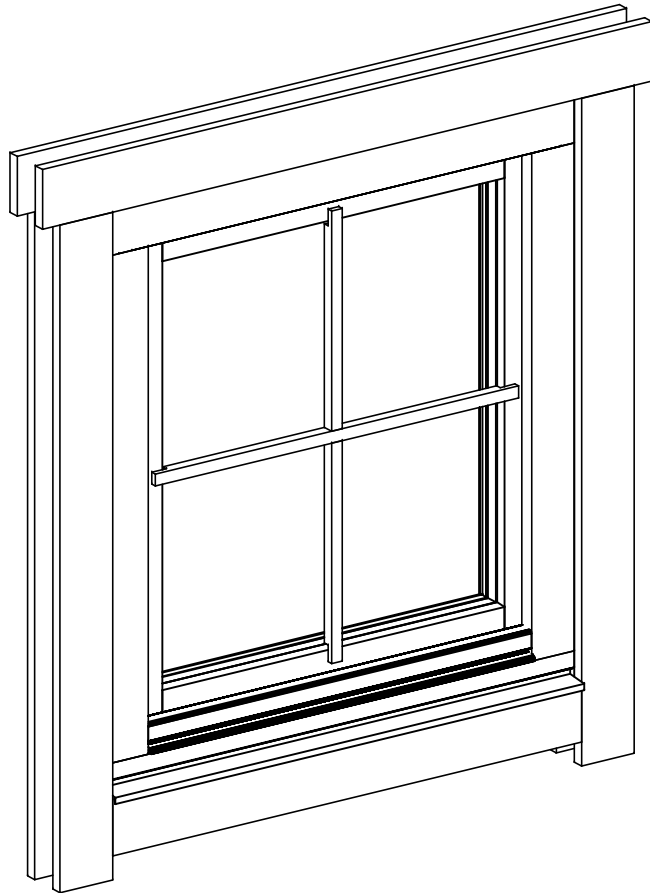

Ukse montaa 0 / Tür montage / Door assembly  
(GH+ / SH)

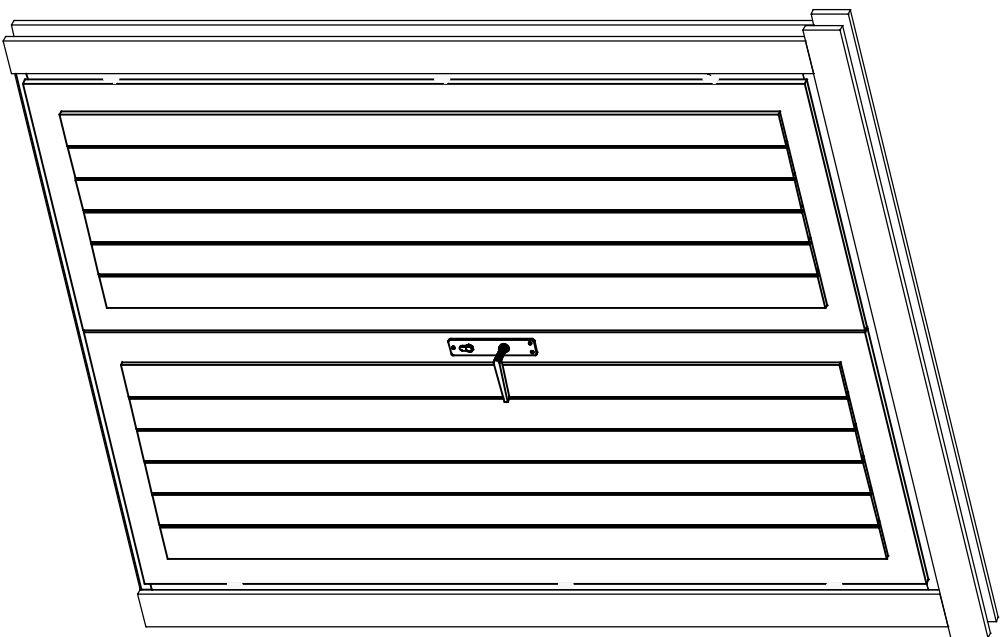

4.5x90

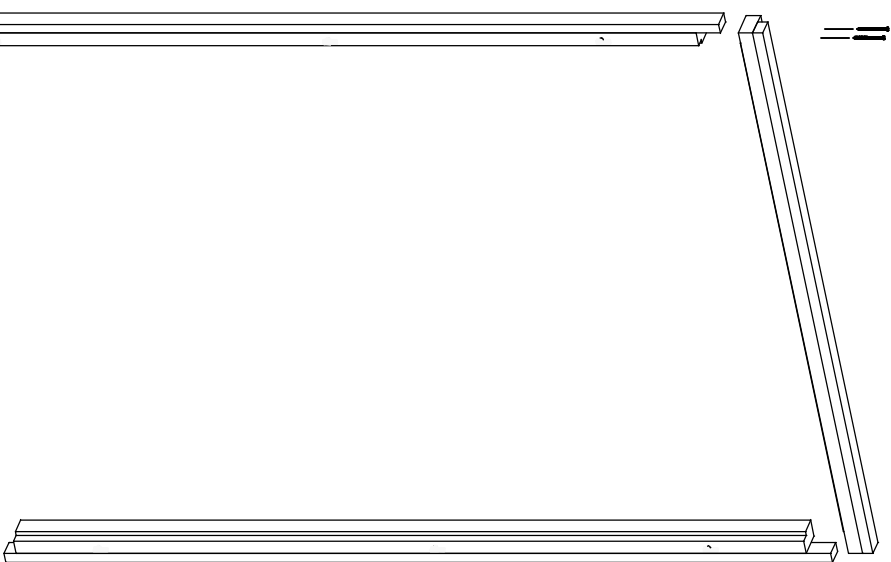

4.5x90



3.5x45

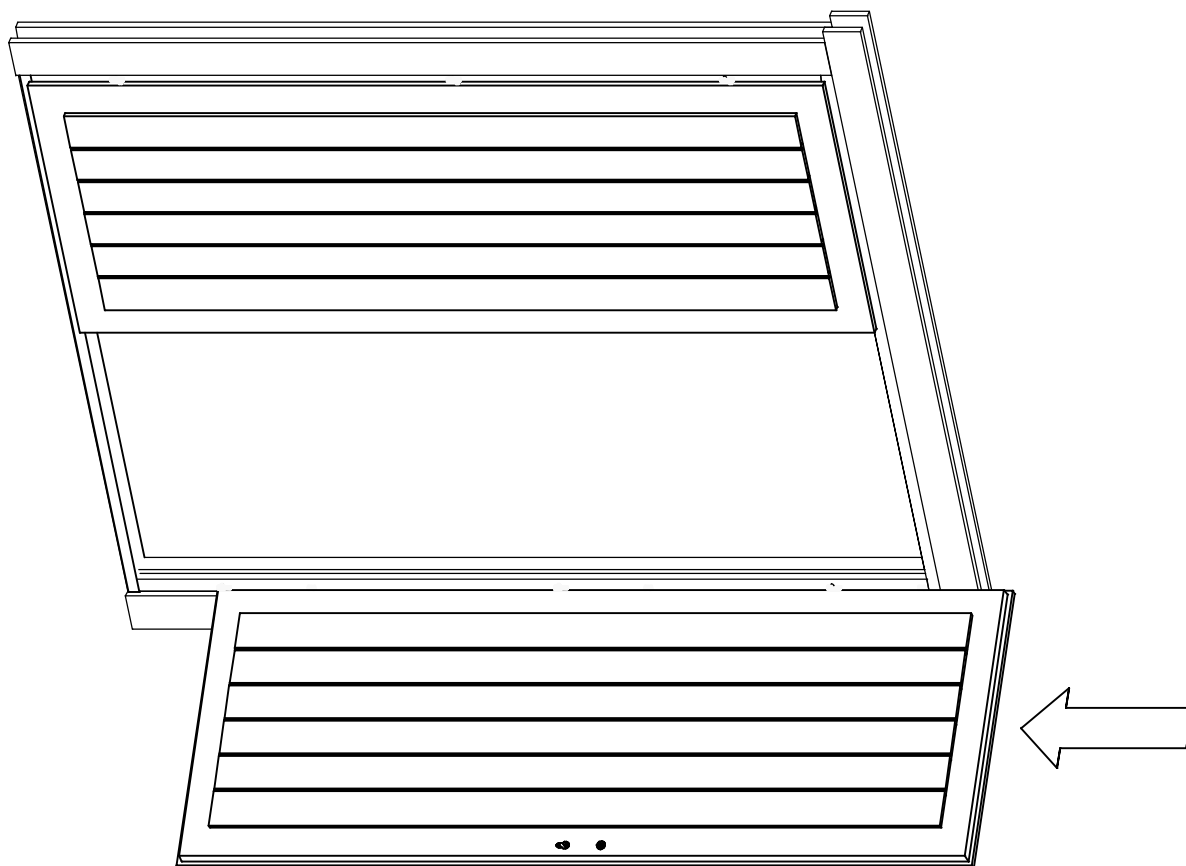
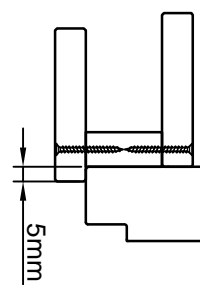
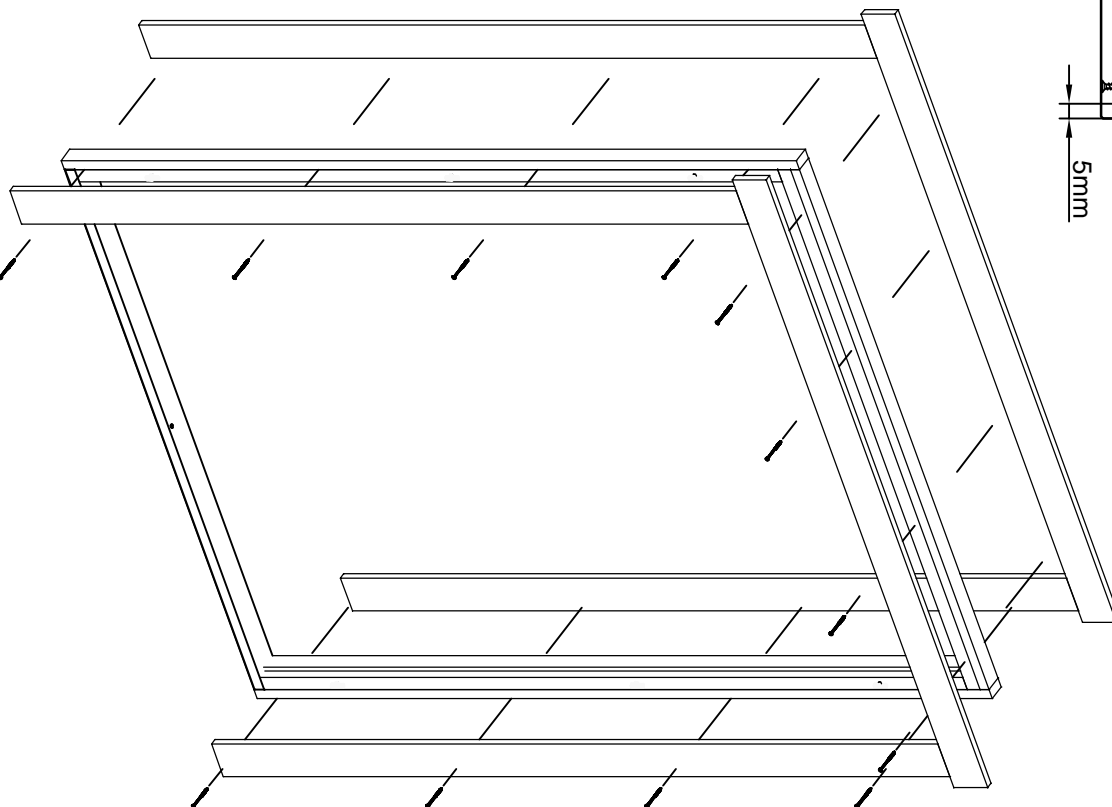

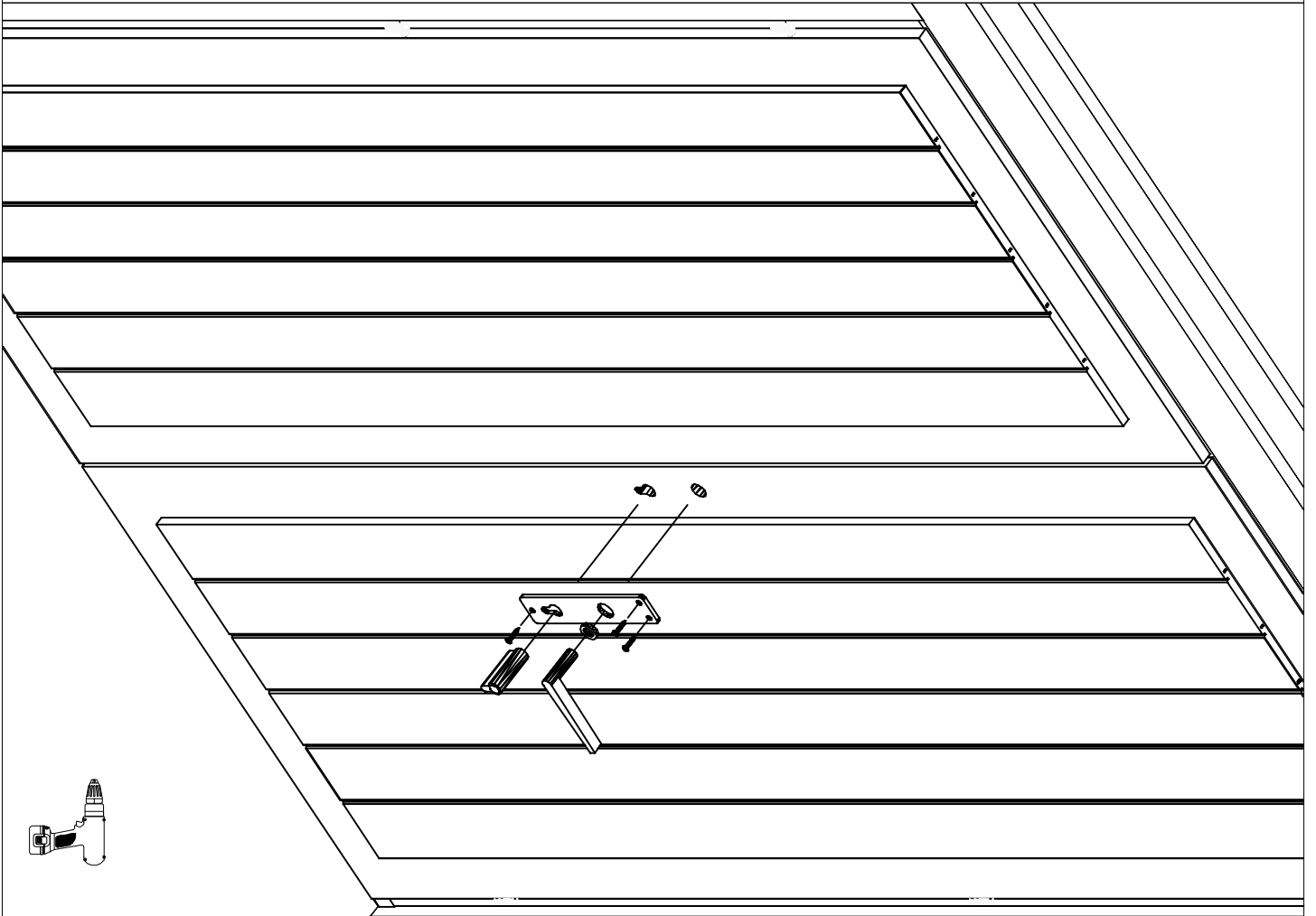
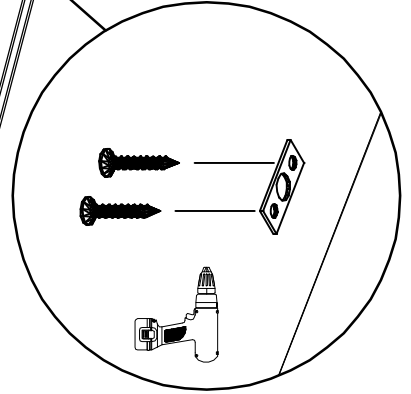
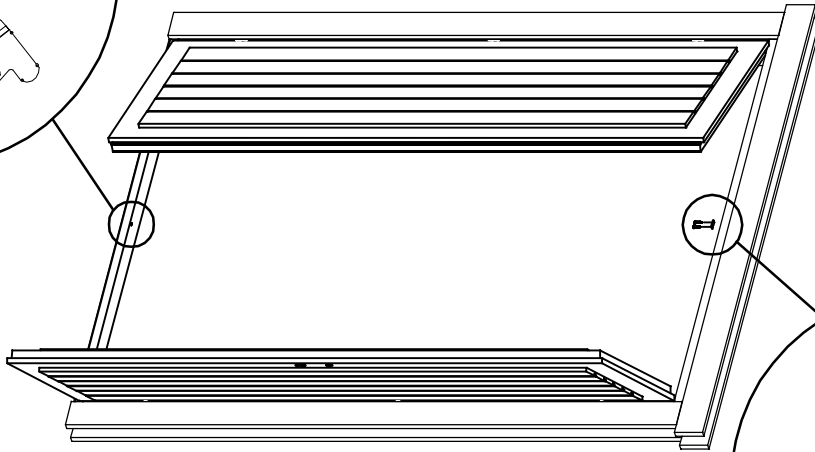
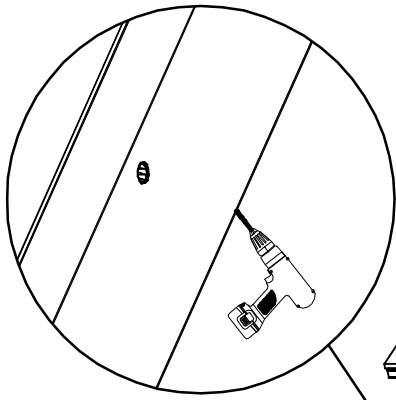

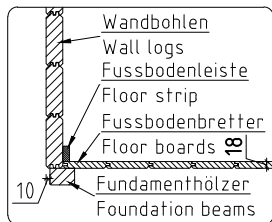
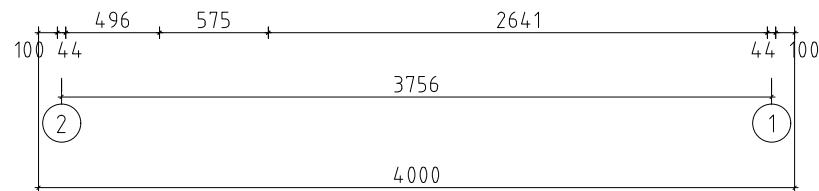
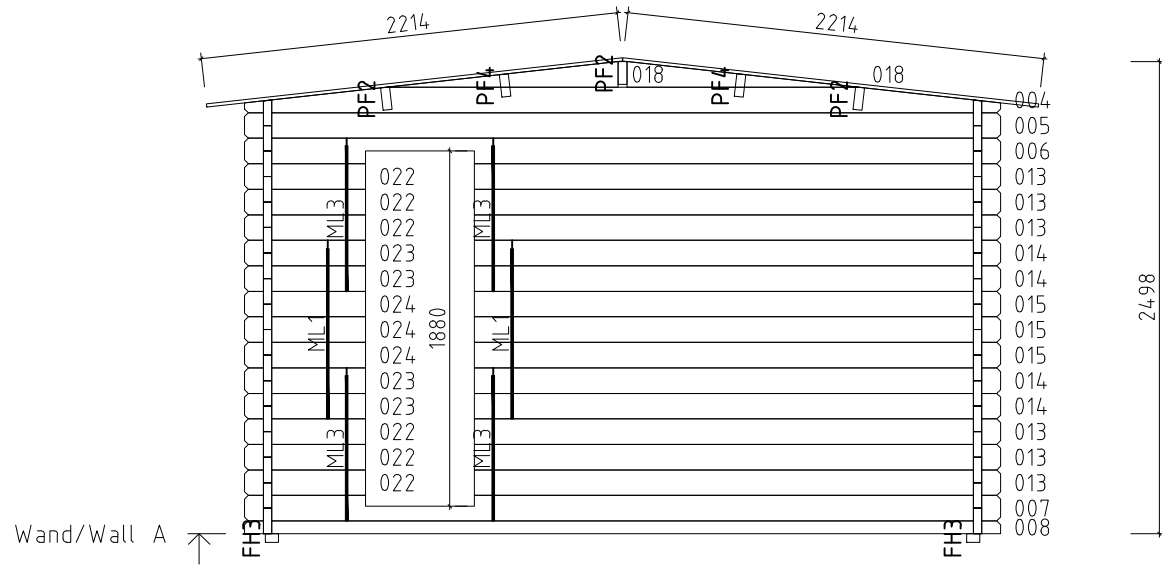
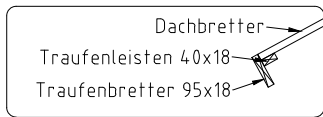

Name		VS44_0066 400x598_44	
Zeichnung/Drawing		WAND/WALL A	
Maßstab/Scale	1:40	Profil/Profile	4.4x13.5
Druck auf/Print on	A4	Datum/Date	25.08.2023

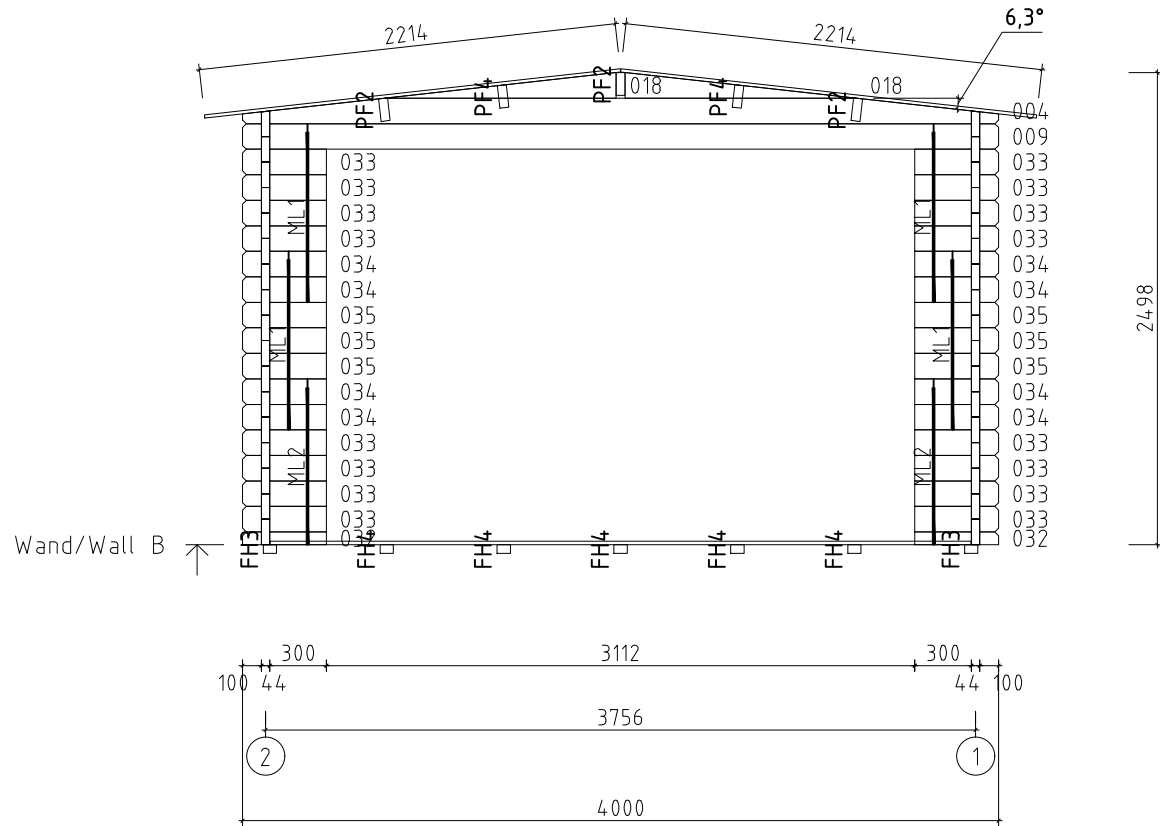

Name		VS44_0066 400x598_44		
Zeichnung/Drawing		WAND/WALL B		
Maßstab/Scale	1:40	Profil/Profile	4.4x13.5	Druck auf/Print on
			A4	Datum/Date
				25.08.2023

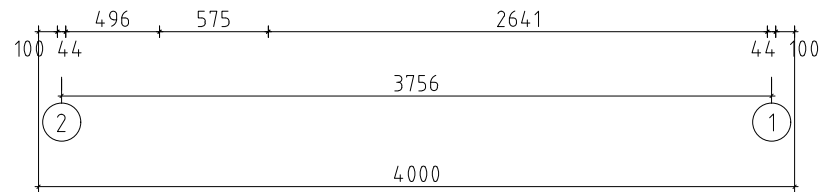
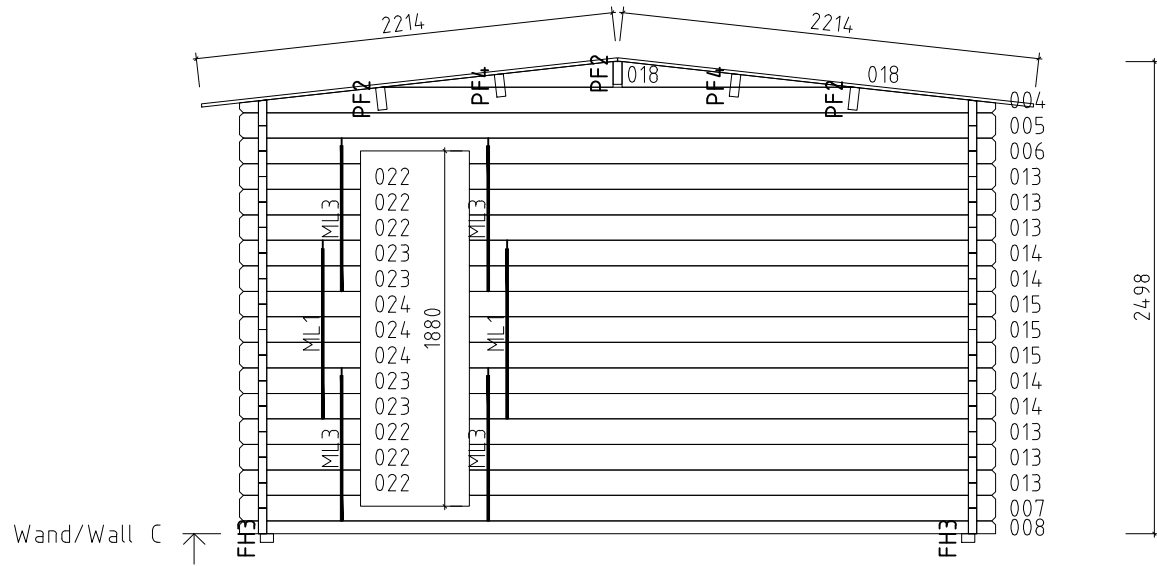

Name				VS44_0066 400x598_44			
Zeichnung/Drawing				WAND/WALL C			
Maßstab/Scale	1:40	Profil/Profile	4.4x13.5	Druck auf/Print on	A4	Datum/Date	25.08.2023

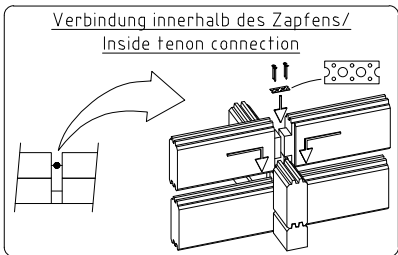
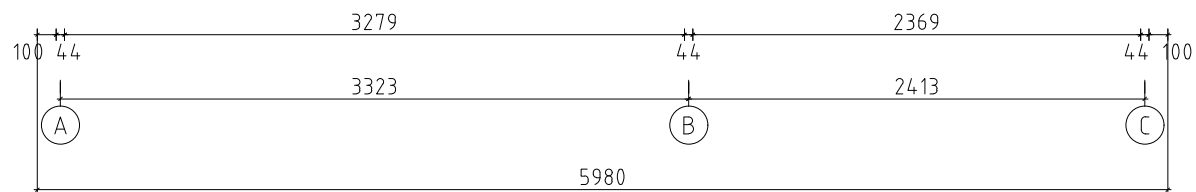
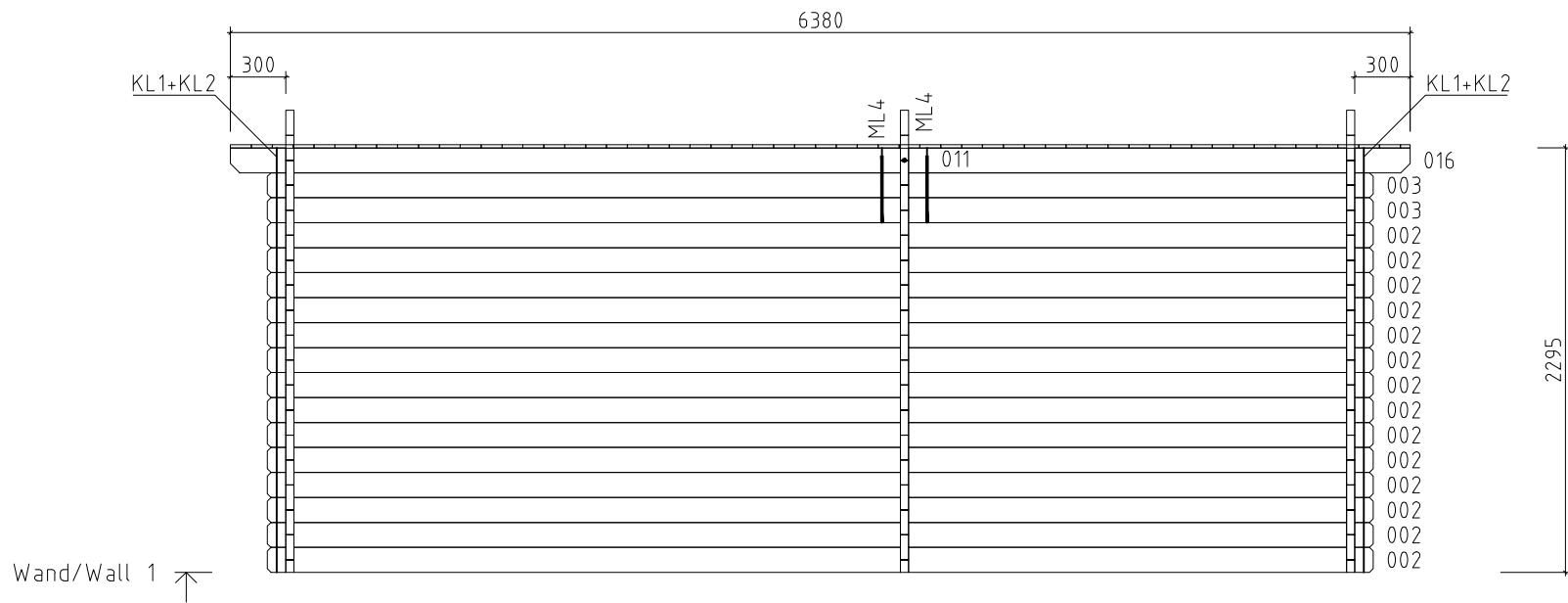

Name		VS44_0066 400x598_44		
Zeichnung/Drawing		WAND/WALL 1		
Maßstab/Scale	1:40	Profil/Profile	4.4x13.5	Druck auf/ Print on
			A4	Datum/Date
				25.08.2023



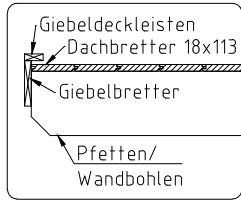

Wand/Wall 2 ↑

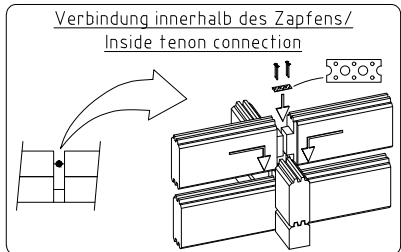
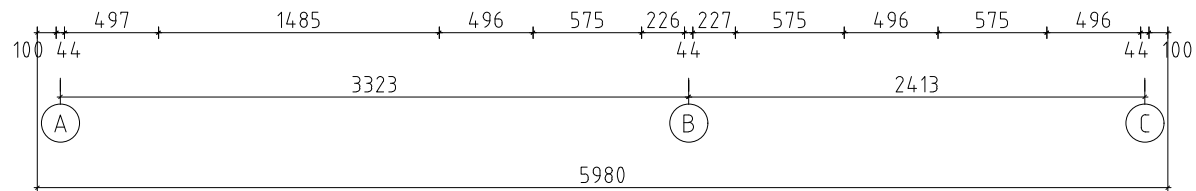
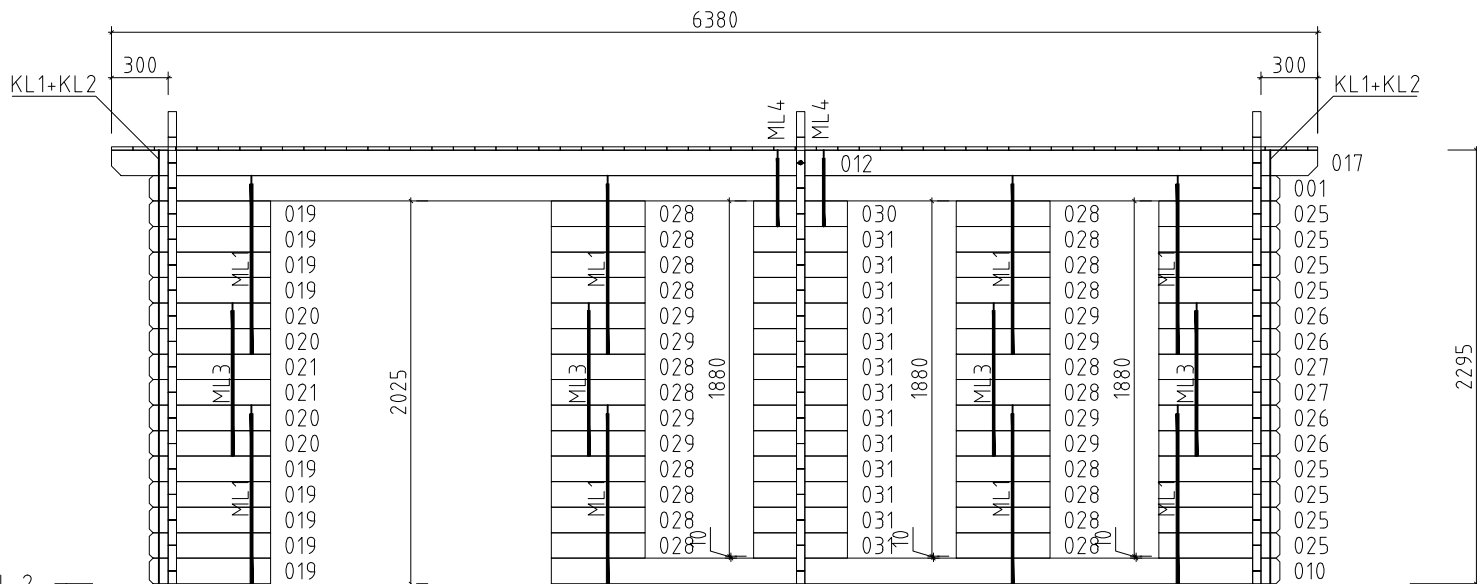

Name		VS44_0066 400x598_44	
Zeichnung/Drawing		WAND/WALL 2	
Maßstab/Scale	1:40	Profil/Profile	4.4x13.5
Druck auf/Print on	A4	Datum/Date	25.08.2023