

## Inspection Certificate

Kontrollschein • Bulletin de contrôle • Certificado de control • Certificato di controllo • Kontrollskjema • Besiktningsprotokoll • Tarkastustodistus • Kontrol Certifikat • Control Certificaat • Certificado de Inspeção • Kontrolní certifikát • Certyfikat kontrolny • Apžiūros pažyma • Pārbaudes akts • Акт осмотра • Kontrollakt

Art. Nr. PA28-3030-3

### Please keep safely!

Bitte gut aufbewahren! • A bien conserver, s.v.p.! • ¡A conservar! • Da conservare! • Ta vare på denne! • Vänligen förvara säkert! • Ole hyvä ja säilytä huolella! • Opbevares sikkert! • Zorgvuldig te bewaren! • Por favor, guarde em segurança! • Prosím, pečlivě uschovejte! • Przechowywać w bezpiecznym miejscu! • Laikykite saugiai! • Lūdzu, glabājiet drošā vietā! • Хранить в надежном месте! • Palun säilitada hoolsalt!

**English:** The product you have purchased was manufactured in accordance with the high quality norms. The product unit has been carefully inspected and packed. In order to avoid possible problems during the assembly carried out by yourself or the building company of your choice, we recommend that you inspect the delivery for its completeness in accordance with the list of pieces before assembly. This inspection must be carried out within 14 days after delivery to your place. Warranty claims are limited to the exchange of defective materials. Defective product parts, which have already been used or painted, are excluded from being replaced. All further claims are excluded! In cases of complaints, please pay attention to the following procedures: Please present this inspection certificate along with the sales receipt to your place of purchase. Only in cases where these documents are presented will the complaint be dealt with quickly and without complications.

**Deutsch:** Der von Ihnen gekaufte Artikel wurde nach der hohen Qualitätsnorm gefertigt. Der Bausatz wurde sorgfältig geprüft und verpackt. Um etwaige auftretende Probleme während des Aufbaus durch Sie oder Ihre Aufbaufirma zu vermeiden, kontrollieren Sie bitte die Lieferung auf Vollständigkeit laut Stückliste vor dem Aufbau. Diese Kontrolle muss innerhalb 14 Tagen nach Anlieferung bei Ihnen erfolgen. Ansprüche auf Gewährleistung beschränken sich auf den Austausch von fehlerhaftem Material. Fehlerhafte Bauteile, die bereits verbaut oder gestrichen wurden, sind vom Umtausch ausgeschlossen. Alle weiteren Ansprüche sind ausgeschlossen! Sollte es zu einer Beanstandung kommen, beachten Sie folgende Vorgehensweise: Legen Sie Ihrem Fachhändler diesen Kontrollschein zusammen mit dem Einkaufsbeleg vor. Nur bei Vorlage dieser Unterlagen ist eine schnelle und problemlose Bearbeitung Ihrer Beanstandung möglich.

**Français:** Le produit que vous venez d'acheter a été fabriqué en respectant de hautes normes de qualité. Ce produit a été testé et emballé avec soin. Afin d'éviter des problèmes éventuels pendant la construction par vous-même ou par la société de construction mandatée, nous vous prions de bien vouloir vérifier que toutes les pièces ont été fournies selon la liste des pièces avant que vous ne commenciez la construction. Il vous incombe de faire ce contrôle dans les 14 jours après la fourniture. Les revendications en dédommagement se limitent à l'échange de matériel défectueux. Les pièces défectueuses, déjà construites ou peintes, ne font pas l'objet de l'échange. Toutes les revendications ultérieures ne sont pas prises en compte ! En cas d'une réclamation, veuillez respecter le déroulement suivant : il vous faudra présenter à votre commerçant agréé ce bulletin de contrôle avec le récépissé de l'achat. Ce ne sera que moyennant présentation de ces documents qu'un traitement rapide et sans problème de votre réclamation sera possible!

**Español:** El producto que ha adquirido ha sido fabricada de acuerdo con normas de alta calidad. Las piezas del producto han sido cuidadosamente inspeccionadas y embaladas. Con el fin de evitar posibles problemas durante el montaje, hecho por usted o por la empresa de construcción de su elección, le recomendamos revisar el paquete entregado, con la lista de piezas, antes de armar el producto. Haga la revisión dentro de 14 días después de recibir el paquete. La garantía se limita a reemplazar las piezas defectuosas. No se reemplazarán las partes defectuosas que ya hayan sido utilizadas o pintadas. ¡No se aceptan otras reclamaciones! En casos de queja, por favor, presente este certificado junto con la factura en el lugar donde hizo la compra. Sólo presentando estos documentos podremos resolver su problema rápidamente y sin complicaciones.

**Italiano:** Il prodotto che avete acquistato è stata prodotta secondo la norma di alta qualità. Il kit è stato controllato ed imballato con cura. Per evitare eventuali inconvenienti durante il montaggio, si prega di verificare, prima del montaggio, la completezza della fornitura in base alla distinta dei pezzi. Tale verifica deve essere effettuata entro 14 giorni dalla consegna. Eventuali diritti di garanzia si limitano alla sostituzione di materiale difettoso. Gli elementi difettosi già montati o verniciati sono esclusi dal diritto alla sostituzione. Ogni altro diritto resta escluso! In caso di reclamazione, procedere nel modo seguente: presentare questo certificato di controllo unitamente alla prova d'acquisto al rivenditore. Solo in questo modo la Sua reclamazione potrà essere evasa rapidamente e senza problemi.

**Norsk:** Produktet du har kjøpt, ble produsert i henhold til høye kvalitetskrav. Produktet har blitt kontrollert nøye og deretter omhyggelig pakket. For å unngå mulige problemer under monteringen, uansett om du gjør det selv eller får en godkjent håndverker til å gjøre det, anbefaler vi at du kontrollerer leveransen mot delelisten for å se om alle delene er inkludert. Denne kontrollen må gjøres innen 14 dager etter at delene ble levert til din adresse. Garantikrav begrenser seg til bytte av defekte deler. Defekte elementer som allerede har blitt brukt eller malt/beiset/limt, vil ikke bli erstattet. Alle andre krav er utelukket! Dersom du har en reklamasjon, vennligst gjør som følger: Lever dette kontrollskjema med kvitteringen til salgsstedet. Bare når du har med disse dokumentene kan klagen behandles raskt og uten komplikasjoner.

**Svenska:** Produkten du köpt har tillverkats i enlighet med de högsta kvalitetsstandarderna. Produktens delar har noggrant besiktigats och förpackats. För att undvika eventuella problem under monteringen som du utför själv eller låter en hantverkare att utföra, rekommenderar vi att du, innan monteringen påbörjas, besiktigar leveransen för att säkerställa att den är komplett enligt förteckningen över ingående delar. Denna besiktning måste utföras inom 14 dagar efter att du tagit emot leveransen. Garantianspråk är begränsade till ersättning av defekt material. Defekta produkt delar, vilka redan har använts eller målats, ersätts inte. Alla vidare anspråk avvisas! I händelse av reklamationer, vänligen uppmärksamma följande: uppvisa detta besiktningsprotokoll tillsammans med inköpsbeviset till ditt inköpsställe. Endast om dessa dokument uppvisas kan vi garantera att reklamationen behandlas skyndsamt och utan krångel.

**Suomi:** Ostamasi tuote on valmistettu korkeita laatuvaatimuksia noudattaen, huolella tarkastettu ja pakattu. Jotta pystytys joko itsesi tai valitsemasi rakennusliikkeen toimesta sujuisi ongelmitta, suosittelimme, että tarkistat toimituksen sisällön osaluettelon avulla ennen kokoamisen aloittamista. Tämä tarkistus tulee tehdä 14 päivän kuluessa toimituksesta. Takuuvaateet rajoittuvat viallisten materiaalien vaihtamiseen. Viallisia osia, joita on jo käytetty ja jotka on maalattu, ei vaihdeta uusiin. Lisävaatimuksia ei huomioida! Mahdollisissa valitustapauksissa toimi seuraavasti: Esitä oheinen tarkastustodistus ja kassakuitti ostopaikassa. Valituksen nopea ja mutkaton käsittely edellyttää näiden asiakirjojen esittämistä.

<p><b>Dansk:</b> Det købte produkt fremstillet i overensstemmelse med de høje kvalitets krav. Produktet er blevet omhyggeligt inspiceret og pakket. For at undgå eventuelle problemer i løbet af monteringen udført af dig selv eller håndværker af dit eget valg, anbefaler vi, at du undersøger leverancen for fuldstændighed i overensstemmelse med listen over dele før samling. Denne inspektion skal foretages inden 14 dage efter levering til din plads. Garantikrav er begrænset til udveksling af defekte materialer. Defekte produkter, som allerede er brugt eller malet, er udelukket fra at blive erstattet. Alle yderligere krav er udelukket! I tilfælde af klager, skal du være opmærksom på følgende procedurer: Venligst præsenterer denne kontrol certifikat sammen med kvitteringen til det sted hvor produktet er købt. Kun i de tilfælde, hvor disse dokumenter er forelagt kan klagen behandles hurtigt og uden komplikationer.</p>
<p><b>Dutch:</b> Het door U gekochte product werd vervaardigd overeenkomstig hoge kwaliteitsnormen. Het product werd zorgvuldig gecontroleerd en verpakt. Om tijdens de montage, uitgevoerd door Uzelf of een door U gekozen aannemer, problemen te vermijden, raden we U aan, vóór de montage de levering te controleren op volledigheid in overeenstemming met de onderdelenlijst. Deze controle dient te gebeuren binnen 14 dagen na levering bij U thuis. Garantieclaims zijn beperkt tot het vervangen van defecte onderdelen. Defecte onderdelen die al gebruikt of geschilderd zijn, zijn uitgesloten van vervanging. Alle latere claims zijn uitgesloten! In geval van klachten dient u als volgt te handelen: Toon dit controlecertificaat, samen met Uw aankoopbewijs aan Uw verkoper. Alleen wanneer deze documenten getoond worden, zal de klacht snel en zonder complicaties in behandeling worden genomen.</p>
<p><b>Português:</b> O produto que comprou foi fabricado em conformidade com as normas de alta qualidade. A unidade do produto foi cuidadosamente inspecionada e embalada. Para evitar possíveis problemas durante a montagem realizada por si ou pela empresa de construção à sua escolha, recomendamos que inspecione a entrega na íntegra, em conformidade com a lista de peças antes da montagem. Esta inspeção deve ser realizada no prazo de 14 dias após a entrega. As reclamações de garantia limitam-se à troca de materiais defeituosos. As peças do produto com defeito, que já tenham sido utilizadas ou pintadas, excluem-se da substituição. Excluem-se todas as outras reclamações! Em caso de reclamações, por favor, tome atenção aos seguintes procedimentos: Por favor, apresente este certificado de inspeção, juntamente com o recibo de venda no seu local de compra. Apenas nos casos em que estes documentos sejam apresentados a queixa será tratada com rapidez e sem complicações.</p>
<p><b>Čeština:</b> Produkt, který jste zakoupil, byl vyroben v souladu s normami stanovujícími vysokou kvalitu. Produkt byl výrobcem pečlivě prohlédnutý a zabaleny. Aby se předešlo možným problémům při montáži prováděné svépomocí nebo stavební firmou dle vašeho výběru, doporučujeme vám před montáží zkontrolovat dodávku na úplnost v souladu se seznamem dílů. Tato prohlídka musí být provedena do 14 dnů (!) od doručení do místa určení. Záruční nároky jsou omezeny na výměnu vadných materiálů. Vadné produkty, které již byly použity nebo které jsou již opatřeny nátěrem, nemohou být nahrazeny. Všechny další nároky jsou vyloučeny! V případě reklamace věnujte prosím pozornost tomuto postupu: Předložte svému prodejci tento kontrolní certifikát spolu s prodejním dokladem. Pouze v případě, kdy jsou předloženy oba tyto dokumenty, lze reklamaci řešit rychle a bez komplikací.</p>
<p><b>Polski:</b> Produkt, który Państwo zakupili, wykonano według najwyższych norm jakości. Elementy konstrukcyjne przed zapakowaniem przeszły dokładną kontrolę jakości. Aby uniknąć problemów podczas samodzielnego montażu, bądź montażu zleconego firmie budowlanej, przed montażem zalecamy sprawdzenie zawartości przesyłki zgodnie z listą części zamieszczonych w zestawie. Kontrola kompletności zestawu należy dokonać w ciągu 14 dni od dostarczenia przesyłki. Reklamacje objęte gwarancją ograniczają się do wymiany wadliwych elementów. Wadliwe elementy, które zostały użyte lub pomalowane nie będą podlegały wymianie ani dalszym reklamacjom. W przypadku potrzeby zgłoszenia reklamacji, prosimy przestrzegać poniższych procedur: prosimy przedłożyć Certyfikat kontrolny wraz z paragonem zakupu i adresem dostawy. Reklamacje będą rozpatrywane wyłącznie po dostarczeniu powyższych dokumentów.</p>
<p><b>Lietuviškai:</b> Produktas, kurį įsigijote, pagamintas pagal aukštos kokybės standartus. Produkto blokas, kurį reikia surinkti, buvo atidžiai patikrintas ir supakuotas. Siekiant išvengti galimų problemų surenkant produktą patiems arba pasirinkus tam norimą statybos bendrovę, prieš surenkant rekomenduojame patikrinti pristatymo komplektaciją pagal dalių sąrašą. Ši patikra turi būti atlikta per 14 dienų nuo pristatymo į jūsų namus vietą. Garantinės sąlygos taikomos tik brokuotoms dalims. Brokuotos produkto dalys, kurios buvo panaudotos arba nudažytos, nebekeičiamos. Visos kitos pretenzijos nesvarstomos! Jei teikiate pretenziją, atkreipkite dėmesį į šias procedūras: į produkto įsigijimo vietą turite pristatyti apžiūros pažymėjimą bei pirkimo kvitą. Tik tais atvejais, kai pristatomi minėti dokumentai, pretenzija gali būti nagrinėjama greitai ir be komplikacijų.</p>
<p><b>Latviešu:</b> Produkts, kuru esat iegādājies, ir ražota saskaņā ar augstām kvalitātes normām. Šī produkta vienība ir rūpīgi pārbaudīta un iepakota. Lai izvairītos no iespējamiem sarežģījumiem montāžas laikā, kuru veicat jūs pats vai jūsu izvēlēts celtniecības uzņēmums, pirms montāžas iesakām pārbaudīt, vai piegādātajam izstrādājumam nekas netrūkst, izmantojot detaļu sarakstu. Šī pārbaude jāveic 14 dienu laikā pēc piegādāšanas. Garantija paredz tikai defektīvo materiālu apmaiņu. Defektīvas produkta detaļas, kuras jau ir izmantotas vai nokrāsotas, netiks mainītas. Visas turpmākās pretenzijas tiks noraidītas! Sūdzību gadījumā, lūdzu, ievērojiet šādu kārtību: lūdzu, uzrādiet šo pārbaudes aktu kopā ar pirkuma čeku izstrādājuma iegādāšanās vietā. Sūdzība tiks atrisināta ātri un bez sarežģījumiem tikai tad, ja tiks uzrādīti šie dokumenti.</p>
<p><b>Русский:</b> Приобретенное вами изделие изготовлено по высоким стандартам качества. Изделие внимательно проверено и упаковано. Во избежание возможных проблем в процессе сборки, выполняемой самостоятельно или привлеченной вами строительной компанией, рекомендуем перед сборкой проверить комплектность поставки по комплектвочной ведомости. Такую проверку следует провести в течение 14 дней после доставки товара. Претензии по гарантии ограничиваются заменой дефектных материалов. Дефектные части изделия, которые уже были использованы или окрашены, замене не подлежат. Все прочие претензии не принимаются! Порядок подачи претензии: Претензия подается с настоящим актом осмотра и товарным чеком по месту покупки товара. Только при наличии всех указанных документов претензия будет рассмотрена быстро и без сложностей.</p>
<p><b>Eesti:</b> Ostetud toode on toodetud vastavuses kõrgete kvaliteedi normidega. Toote ühik on hoolikalt kontrollitud ja pakendatud. Et vältida võimalikke probleeme paigaldamisel, mida teostate ise või teostab teie poolt valitud paigaldusettevõte, soovime enne paigaldama asumist kontrollida toote komplekssust detailide nimekirja alusel, mille leiate kaasas olevast juhendist. See kontroll tuleb teostada 14 päeva jooksul pärast tarnet. Garantii alla kuuluvad kaebused on piiratud defektsete detailide välja vahetamisega. Defektsed detailid, mida on juba kasutatud või värvitud, ei kuulu garantiikorras välja vahetamisele. Kõik edasised kaebused on välistatud! Kaebuste korral palun pöörake tähelepanu järgnevale: palun hoidke see kontrollakt koos müügiarvega alles. Ainult nende dokumentide esitamisel lahendatakse kaebused kiiresti ja ilma komplikatsioonideta.</p>

**The producer shall have the right to make technical changes to the product.** • Technische Änderungen vorbehalten. • Le producteur réserve le droit d'effectuer des modifications techniques au produit. • Reservado el derecho a modificaciones técnicas. • Il produttore mantiene il diritto di apportare modifiche tecniche al prodotto. • Producent forbeholder seg retten til å endre tekniske egenskaper ved produktet. • Tillverkaren har rätt att utföra tekniska förändringar för produkten. • Valmistaja pidättää oikeuden tehdä tuotteen teknisiä muutoksia. • Producenten har ret til at foretage tekniske ændringer ved produktet. • Alle rechten en technische wijzigingen voorbehouden. • O fabricante reserva-se o direito de realizar alterações técnicas ao produto. • Výrobce je oprávněn provádět technické úpravy produktu. • Producent zastrzega sobie prawo do dokonywania zmian technicznych produktu. • Gamintojas turi teisę atlikti techninius gaminio pakeitimus. • Ražotājs patur tiesības veikt tehniskas produkta izmaiņas. • Производитель оставляет за собой право вносить в изделие технические изменения. • Tootja jätab endale õiguse muuta toote tehnilisi omadusi.

**To be completed by buyer! (Please use block letters)** • Vom Käufer auszufüllen! (Bitte in Druckschrift) • A remplir par l'acheteur! (en lettres d'imprimerie, s'il vous plaît) • ¡Completa el cliente! (en mayúsculas) • Da compilare dall'acquirente! (in stampatello) • Fylles ut av kjøper! (Vær vennlig å bruke blokkbokstaver) • Fylls i av köparen! (Vänligen texta) • Ostaja täyttää! (Ole hyvä ja käytä isoja kirjaimia) • Udfyldes af køber! (Benyt venligst Blokbogstaver) • In te vullen door de verkoper! (Graag in drukletters) • A completar pelo fabricante! (por favor escreva em letra de máquina) • Vyplní kupující! (Prosíme hůlkovým písmem) • Wypełnia nabywca (drukowanymi literami) • Pildo pirkėjas (didžiosiomis raidėmis)! • Aizpilda pircējs! (Lūdzu, izmantojiet drukātos burtus.) • Заполняется покупателем! (печатными буквами) • Täidetakse ostja poolt! (palun täita trükitähedede):

**Place of purchase** • Bezugsquelle • Source d'achat • Lugar de compra • Acquistato presso • Salgs sted • Inköpsställe • Ostopaikka • Salgssted • Plaats van aankoop • Local de compra • Místo nákupu • Miejsce zakupu • Įsigijimo data • Iegādāšanās vieta • Место покупки товара • Ostukoht:

**Sales receipt No.** • Kaufbeleg-Nr. • Récépissé n° • Recibo N° • Prova d'acquisto N. • Kvitteringsnr • Försäljningskvittots nummer • Kassakuitin numero • Kasse Bon nr • Aankoopbewijs Nr. • Recibo de venda n.º • Prodejní doklad č. • Nr paragonu • Pardavimo kvito Nr. • Pirkuma čeka Nr. • Номер товарного чека • Müügiarve number:

**Sales receipt date** • Kaufbeleg-Datum • Date du récépissé • Fecha recibo • Data prova d'acquisto • Kvitteringsdato • Försäljningskvittots datum • Kassakuitin päiväys • Kasse bons dato • Aankoopbewijs -Datum • Data do recibo de venda • Datum prodejního dokladu • Data paragonu • Pirkimo kvito data • Pirkuma čeka datums • Дата товарного чека • Müügiarve kuupäev:

**Delivery date** • Lieferdatum • Date de livraison • Fecha de Entrega • Data di consegna • Leveringsdato • Leveransdatum • Toimituspäivä • Leverings dato • Leveringsdatum • Data de entrega • Termín dodání • Data dostawy • Pristatymo data • Piegādes datums • Дата доставки • Tāme kuupäev:

**Buyer's address** • Kundenanschrift • Adresse du client • Dirección del cliente • Indirizzo del cliente • Kjøpers adresse • Köparens adress • Ostajan osoite • Købers adresse • Adres koper • Morada do comprador • Adresa kupujícího • Adres nabywcy • Pirkėjo adresas • Pircēja adrese • Адрес покупателя • Ostja address:

**Telephone** • Telefon • Téléphone • Teléfono • Telefono • Telefon nr • Telefon • Puhelin • Telefon • Telefoon • Telefone • Telefon • Telefon • Telefonas • Tālrunis • Телефон • Telefon:

**Forwarder:**  Pick-up  Others •

Afhalen:  Spedition  Selbstabholer •

Par:  Transporteur  Propres moyens •

Entrega:  Transporte organizado  Transporte propio •

Tramite:  Spedizioniere  Mezzo proprio •

Transportør:  Sendes  Hentes •

Speditör:  Avhämtning  Övrigt •

Rahdinkuljettaja:  Nouto  Muut •

Transportør:  Sendes  Hentes •

Door:  Verzending  Zelf •

Remetente:  Entrega  Outros •

Zasílatel:  Sběrná služba  Ostatní •

Przekazywanie:  Odbiór w sklepie  Inne •

Ekspeditorius:  "Pick-up"  Kita •

Ekspeditoris:  Saņemšana uz vietas  Cits •

Экспедитор:  Приемка  Прочее •

Transport:  Järgi tulemine  Muu

**Description of complaint** • Schilderung der Beanstandung • Description de la réclamation • Descripción del problema • Descrizione della reclamazione • Beskrivelse av feil/ mangel • Beskrivning av reklamationen • Valituksen kuvaus • Beskrivelse af fejl / Mangel • Beschrijving van de klacht • Descrição da reclamação • Popis reklamace • Opis reklamacji • Skundo aprašymas • Sūdzības apraksts • Содержание претензии • Kaebuse kirjeldus

**Please keep the parts which are the object of the complaint until the complaint is settled!** • Bitte bewahren Sie unbedingt alle die Reklamation betreffenden Bauteile/Gegenstände auf, bis die Bearbeitung abgeschlossen ist. • Veuillez garder les pièces contestées jusqu'à ce que la réclamation soit traitée définitivement! • Por favor, conserve las piezas objeto de la queja hasta que el problema haya sido resuelto • Si prega di conservare i pezzi reclamati fino all'evasione della reclamazione! • Vær vennlig å ta vare på de aktuelle delene/ produktet inntil saken er avsluttet! • Vänligen behåll delarna som är föremål för reklamation tills reklamationen har behandlats! • Ole hyvä ja säilytä osat, joita valitus koskee, kunnes valitus on käsitelty! • Venligst ta hånd om de aktuelle dele / produkt indtil sagen er afsluttet! • Gelieve de betrokken onderdelen te bewaren tot de klacht is afgehandeld • Por favor, guarde as peças objeto da reclamação, até que a reclamação esteja resolvida! • Uchovajte prosím díly, které jsou předmětem stížnosti, dokud reklamace nebude vyřízena! • Prosimy zachować części będące przedmiotem reklamacji do czasu jej rozpatrzenia. • Dalis, kurios yra skundo objektas, reikia išsaugoti tol, kol skundas bus išnagrinėtas! • Lūdzu, saglabājiet detaļas, uz kurām sūdzība attiecas, līdz sūdzība tiek atrisināta! • Просим сохранить части, являющиеся предметом претензии, до ее разрешения! • Palun hoidke kaebust puudutavad objektid/detailid alles, kuni kaebus on lahendatud!

# Assembly, installation and maintenance manual

Montage-, Aufbau- und Wartungsanleitung • Assemblage, manuel de montage et d'entretien • Montaje, instalación, y mantenimiento • Manuale di montaggio, installazione e manutenzione • Monterings- og vedlikeholdsmanual • Monterings-, installations- och underhållsmanual • Kokoamis-, asennus- ja huolto-ohje • Vejledning for montering og vedligehold • Handleiding voor montage, installatie en onderhoud • Manual de montagem, instalação e manutenção • Návod k montáži, instalaci a údržbě • Instrukcja montażu, instalacji i konserwacji • Surinkimo, montavimo ir priežiūros vadovas • Montāžas, uzstādīšanas un apkopes rokasgrāmata • Руководство по сборке и обслуживанию • Montaaži-, paigaldus- ja säilitamise juhend



## Pavilion PA28-3030-3

### Treatment options, Item code •

Behandlungsoptionen, Artikel-Code • Traitement options, code de l'article • Tratamiento opciones, código del artículo • Opzioni di trattamento, codice articolo • Behandlingsalternativer, artikkelnummer • Behandlingsalternativ, varukod • Käsittelevaihtoehdot, yksikön koodi • Behandlingsmuligheder, artikel nummer • Behandlingsopties, artikkelnummer • Opções de tratamento, código do artigo • Povrchové úpravy, kód položky • Możliwości leczenia, kod produktu • Apdorojimo variantai, prekės kodas • Apstrādes iespējas, artikula kods • Варианты обработки, код изделия • Tõõtlusvõimalused, tootekood











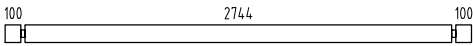
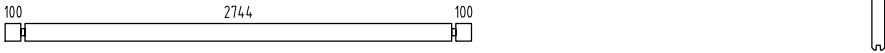
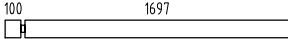
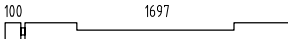

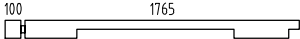
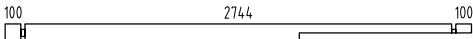
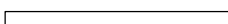

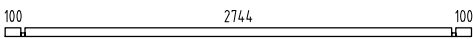
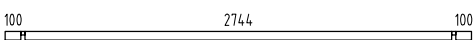
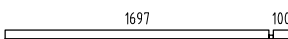
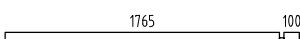
**NO** 103712  
**BNDIP** 108925  
**GYDIP** 108926  
**WTDIP** 108924

**Factory inspection by** • Werkskontrolle durch • Contrôle à partir de l'usine par • Inspector de fábrica • Collaudato da • Fabrikkkontroll utført av • Fabriksbesiktigat av • Tehtaan tarkastaja • Fabriks Kontrol udført af • Fabrikscontrole door • Inspeção de fábrica, por: • Zkontrolováno ve výrobním závodě • Kontrola fabryczna do • Apžiūrą gamykloje atliko • Rūpnīcas pārbaudi veicis • Заводской контроль • Tehase kontroll teostatud:









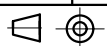

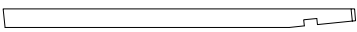
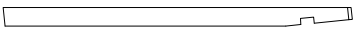
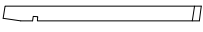
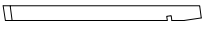



.....

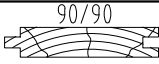

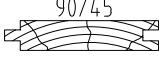
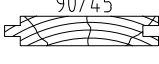
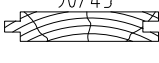
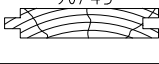
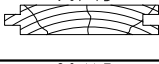

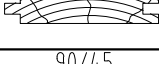

**Date** • Datum • Date • Fecha • Data • Dato • Datum • Päiväys • Dato • Datum • Data • Datum • Data • Datums • Data • Дата • Kuupäev:

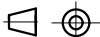
**Pack number** • Pack Nr. • Packet n° • Paquete N° • Pacco N. • Serienr • Produktionsnummer • Pakettinro • Pakke nr. • Pak nr. • Número de embalagem • Číslo balení • Numer opakowania • Pakuotės numeris • Iepakojuma numurs • Упаковочный номер • Pakinumber:

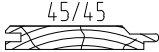
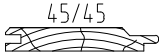

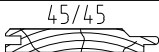
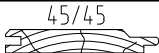
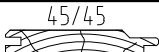
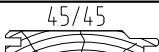
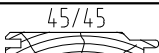
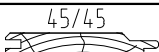
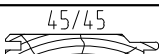
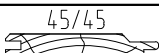
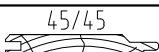
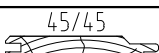
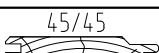
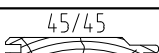
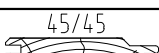
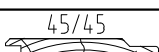
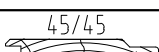





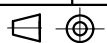

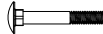
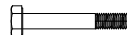

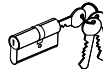









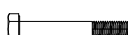



Pos	SPECIFICATION-STÜCKLISTE-NOMENCLATURE-ELEMENTI-ESPECIFICACIÓN PA28-3030-3	Pcs	Profile (mm)	Length (mm)
001		37	28x114	3000
002		2	28x114	3000
003		4	28x114	1825
004		1	28x114	1825
005		27	28x114	460
006		27	28x114	352
007		1	28x114	1893
008		1	28x114	3000
009		1	28x114	1440
010		1	28x57	1440
011		1	28x57	3000
012		2	28x57	3000
013		1	28x57	1825
014		1	28x114	1893
AR4	Foundation- Fundament- Fondation- Fondazione- Vigas de cimentación 	1	45x70	2790
AR1	Foundation- Fundament- Fondation- Fondazione- Vigas de cimentación 	4	45x70	2700
AR2	Foundation- Fundament- Fondation- Fondazione- Vigas de cimentación 	1	45x70	2180
AR6	Foundation- Fundament- Fondation- Fondazione- Vigas de cimentación 	1	45x70	1758
AR3	Foundation- Fundament- Fondation- Fondazione- Vigas de cimentación 	1	45x70	1713
AR5	Foundation- Fundament- Fondation- Fondazione- Vigas de cimentación 	2	45x70	1460
EaE1	Eave edging- Dachrandbrett- Madrier en bordure du toit- Tavola bordo tetto- Tabla de valadizo 	4	95x19	3220
Pst2	Post- Pfosten- Poteau- Montante- Poste 	1	70x70	1910
Pst1	Post- Pfosten- Poteau- Montante- Poste 	1	70x70	1910





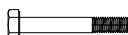
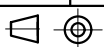

Pos	SPECIFICATION-STÜCKLISTE-NOMENCLATURE-ELEMENTI-ESPECIFICACIÓN PA28-3030-3			Pcs	Profile (mm)	Length (mm)
RoR1	Rafter- Sparre- Chevron- Trave- Cabrio 			2	120x44	2268
RoR2	Rafter- Sparre- Chevron- Trave- Cabrio 			2	120x44	2246
RoR4	Rafter- Sparre- Chevron- Trave- Cabrio 			4	95x44	1275
RoR3	Rafter- Sparre- Chevron- Trave- Cabrio 			4	95x44	1275
RoR6	Rafter- Sparre- Chevron- Trave- Cabrio 			4	95x44	608
RoR5	Rafter- Sparre- Chevron- Trave- Cabrio 			4	95x44	608
Sla1	Slat- Leiste- Baguette- Listello- Listón 			1	19x28	1520
UP1	U-profile board- U-Profilleiste- Baguette profilée en U- Listello profilo ad U- Listón de perfil U 			12	44x81	616
UP3	U-profile board- U-Profilleiste- Baguette profilée en U- Listello profilo ad U- Listón de perfil U 			4	44x81	360
UP2	U-profile board- U-Profilleiste- Baguette profilée en U- Listello profilo ad U- Listón de perfil U 			4	44x81	360
FB2-1	Floor board- Fussbodenbrett- Madrier du plancher - Tavola pavimento- Tabla de suelo		20	89x19	2735	
2FB2-1	Floor board- Fussbodenbrett- Madrier du plancher - Tavola pavimento- Tabla de suelo 2		1	89x19	2735	
2FB2-2	Floor board- Fussbodenbrett- Madrier du plancher - Tavola pavimento- Tabla de suelo 2		1	89x19	2646	
2FB2-3	Floor board- Fussbodenbrett- Madrier du plancher - Tavola pavimento- Tabla de suelo 2		1	89x19	2557	
2FB2-4	Floor board- Fussbodenbrett- Madrier du plancher - Tavola pavimento- Tabla de suelo 2		1	89x19	2468	
2FB2-5	Floor board- Fussbodenbrett- Madrier du plancher - Tavola pavimento- Tabla de suelo 2		1	89x19	2379	
2FB2-6	Floor board- Fussbodenbrett- Madrier du plancher - Tavola pavimento- Tabla de suelo 2		1	89x19	2290	
2FB2-7	Floor board- Fussbodenbrett- Madrier du plancher - Tavola pavimento- Tabla de suelo 2		1	89x19	2201	
2FB2-8	Floor board- Fussbodenbrett- Madrier du plancher - Tavola pavimento- Tabla de suelo 2		1	89x19	2112	
2FB2-9	Floor board- Fussbodenbrett- Madrier du plancher - Tavola pavimento- Tabla de suelo 2		1	89x19	2023	
2FB2-10	Floor board- Fussbodenbrett- Madrier du plancher - Tavola pavimento- Tabla de suelo 2		1	89x19	1934	
2FB2-11	Floor board- Fussbodenbrett- Madrier du plancher - Tavola pavimento- Tabla de suelo 2		1	89x19	1845	
2FB2-12	Floor board- Fussbodenbrett- Madrier du plancher - Tavola pavimento- Tabla de suelo 2		1	89x19	1756	
						
Object name PA28-3030-3					Page 2/5	

Pos	SPECIFICATION-STÜCKLISTE-NOMENCLATURE-ELEMENTI-ESPECIFICACIÓN PA28-3030-3		Pcs	Profile (mm)	Length (mm)
RB1-1	Roof board- Dachbrett- Madrier du toit- Tavola tetto- Tabla de tejado		4	89x16	3168
RB1-2	Roof board- Dachbrett- Madrier du toit- Tavola tetto- Tabla de tejado		4	89x16	2992
RB1-3	Roof board- Dachbrett- Madrier du toit- Tavola tetto- Tabla de tejado		4	89x16	2816
RB1-4	Roof board- Dachbrett- Madrier du toit- Tavola tetto- Tabla de tejado		4	89x16	2639
RB1-5	Roof board- Dachbrett- Madrier du toit- Tavola tetto- Tabla de tejado		4	89x16	2463
RB1-6	Roof board- Dachbrett- Madrier du toit- Tavola tetto- Tabla de tejado		4	89x16	2287
RB1-7	Roof board- Dachbrett- Madrier du toit- Tavola tetto- Tabla de tejado		4	89x16	2111
RB1-8	Roof board- Dachbrett- Madrier du toit- Tavola tetto- Tabla de tejado		4	89x16	1934
RB1-9	Roof board- Dachbrett- Madrier du toit- Tavola tetto- Tabla de tejado		4	89x16	1758
RB1-10	Roof board- Dachbrett- Madrier du toit- Tavola tetto- Tabla de tejado		4	89x16	1582
RB1-11	Roof board- Dachbrett- Madrier du toit- Tavola tetto- Tabla de tejado		4	89x16	1406
RB1-12	Roof board- Dachbrett- Madrier du toit- Tavola tetto- Tabla de tejado		4	89x16	1229
RB1-13	Roof board- Dachbrett- Madrier du toit- Tavola tetto- Tabla de tejado		4	89x16	1053
RB1-14	Roof board- Dachbrett- Madrier du toit- Tavola tetto- Tabla de tejado		4	89x16	877
RB1-15	Roof board- Dachbrett- Madrier du toit- Tavola tetto- Tabla de tejado		4	89x16	701
RB1-16	Roof board- Dachbrett- Madrier du toit- Tavola tetto- Tabla de tejado		4	89x16	524
RB1-17	Roof board- Dachbrett- Madrier du toit- Tavola tetto- Tabla de tejado		4	89x16	348
RB1-18	Roof board- Dachbrett- Madrier du toit- Tavola tetto- Tabla de tejado		4	89x16	172
FIB2-1	Floor beading- Fussbodenleiste- Baguette du plancher- Listello pavimento- Listón de suelo		5	19x19	2744
Rel-1	Roof element- Dachelement- Panneau de toit- Elemento di tetto- Elemento tejado		1		1385
StB1-1	Storm brace- Sturmleiste- Protection contre le vent- Antivento- Protector contra tormentas		5	25x45	2150

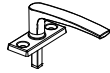
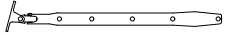
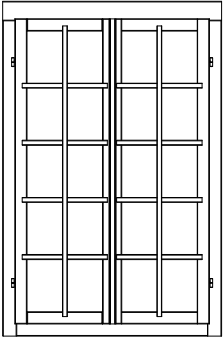

Pos	SPECIFICATION-STÜCKLISTE-NOMENCLATURE-ELEMENTI-ESPECIFICACIÓN PA28-3030-3	Pcs	
Fim	-Fixing kit- Befestigungsset- Moyens de fixation- Materiale di fissaggio- Kit de fijación	1	USE
QPOYP 8x60Zn	Bolt -Schloss-schraube -Boulon- Bullone- Perno- M8x60mm PUP0		10 StB1-1
QPOKK1 0x70Zn	Bolt -Schloss-schraube -Boulon- Bullone- Perno- M10x70mm KSP0		4 
QULSI 30x35	Cylinder- Zylinderschloss- Serrure a mortaiser- Serratura a cilindro- Bombin- 30.35		1 TU28-61P
QLIU KAPal	Door fittings- Türbeschlag- Ferrure- Ferramenta porta- Manilla puerta- QLIUKAPal		1 TU28-61P
QHA1 50Zn	Hook- Haken- Crochet- Ganzio- Pestillo QHA150Zn		2 TU28-61P
QRV1 20Zn	Keeper- Schliessblech- Tole- Lamiera- Aldaba de candado- 120Zn		1 TU28-61P
QNU10 5x105 x90Zn	L-iron- Winkel- Angle -Angolo- Angulo- QNU105x105x90Zn		4 RoR1+RoR2
QNA1 4x40Me	Nail- Nagel- Clou- Chiodo- Clavo- 1.4x40mm		30 FIB2-1
QNA2 2x50Zn	Nail- Nagel- Clou- Chiodo- Clavo- 2.5x50mm		500 FB2-1; 2FB2-1 RB1-1
QNA4x 120Zn	Nail- Nagel- Clou- Chiodo- Clavo- 4x120mm		16 ARx
QMUk K8Zn	Nut- Schraubenmutter- Écrou- Dado- Tuerca- M8mm		10 
QMUk K10Zn	Nut- Schraubenmutter- Écrou- Dado- Tuerca- M10mm		4 
QK04	Roof cap- Dachkappe- Finition métallique- Finitura di tetto- Caballete de tejado- QK04		1
QKRPP2 _5x16Zn	Screw- Schraube- Vis- Vite- Tornillo- 2.5x16mm Zn		2 
QKRPP3 _5x50Zn	Screw- Schraube- Vis- Vite- Tornillo- 3.5x50mm		110 UP1; UP2; UP3 Rel-1; EaE1
QKRYp 3x16Zn	Screw- Schraube- Vis- Vite- Tornillo- 3x16mm ZnY		4 
QKRPP 3x20Zn	Screw- Schraube- Vis- Vite- Tornillo- 3x20mm		60 TU28-61P TA28-12P
QKRPP4 _5x70Zn	Screw- Schraube- Vis- Vite- Tornillo- 4.5x70mm		30 003; 011; 012;
QKRYp5 x40ZnTX	Screw- Schraube- Vis- Vite- Tornillo- 5x40mm		32 
QKRPP 5x90Zn	Screw- Schraube- Vis- Vite- Tornillo- 5x90mm		70 TU28-61P RoRx
QSE8 x24Zn	Washer- Dichtscheibe- Joint- Rondella- Arandela- 8x24mm DIN9021		10 
QSE10 x30Zn	Washer- Dichtscheibe- Joint- Rondella- Arandela- 10x30mm		8 
	Object name PA28-3030-3		Page 4/5

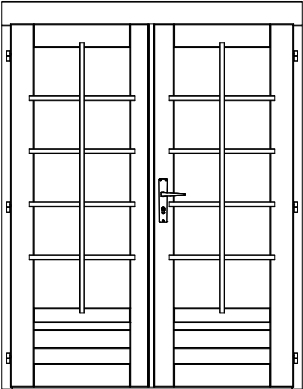

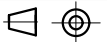
Pos	SPECIFICATION-STÜCKLISTE-NOMENCLATURE-ELEMENTI-ESPECIFICACIÓN PA28-3030-3	Pcs	
QLIA	Window fittings- Fenstergriff- Poigne de la fenêtre- Maniglia finestra- Manilla (ventana) 	4	TA28-12P
QFK2 40Zn	Window stop- Fensterfeststelle- Crémaillère- Fissativo finestra- Fijador de ventana- QFK240Zn 	4	TA28-12P
TA28 -12P	Window - Fenster - Fenetre - Finestra-Ventana 1003x1549   903x1449mm	2	
TU28 -61P	Door - Tür - Porte - Porta-Puerta 1440x1822   1340x1752mm	1	
	Object name PA28-3030-3	Page	5/5

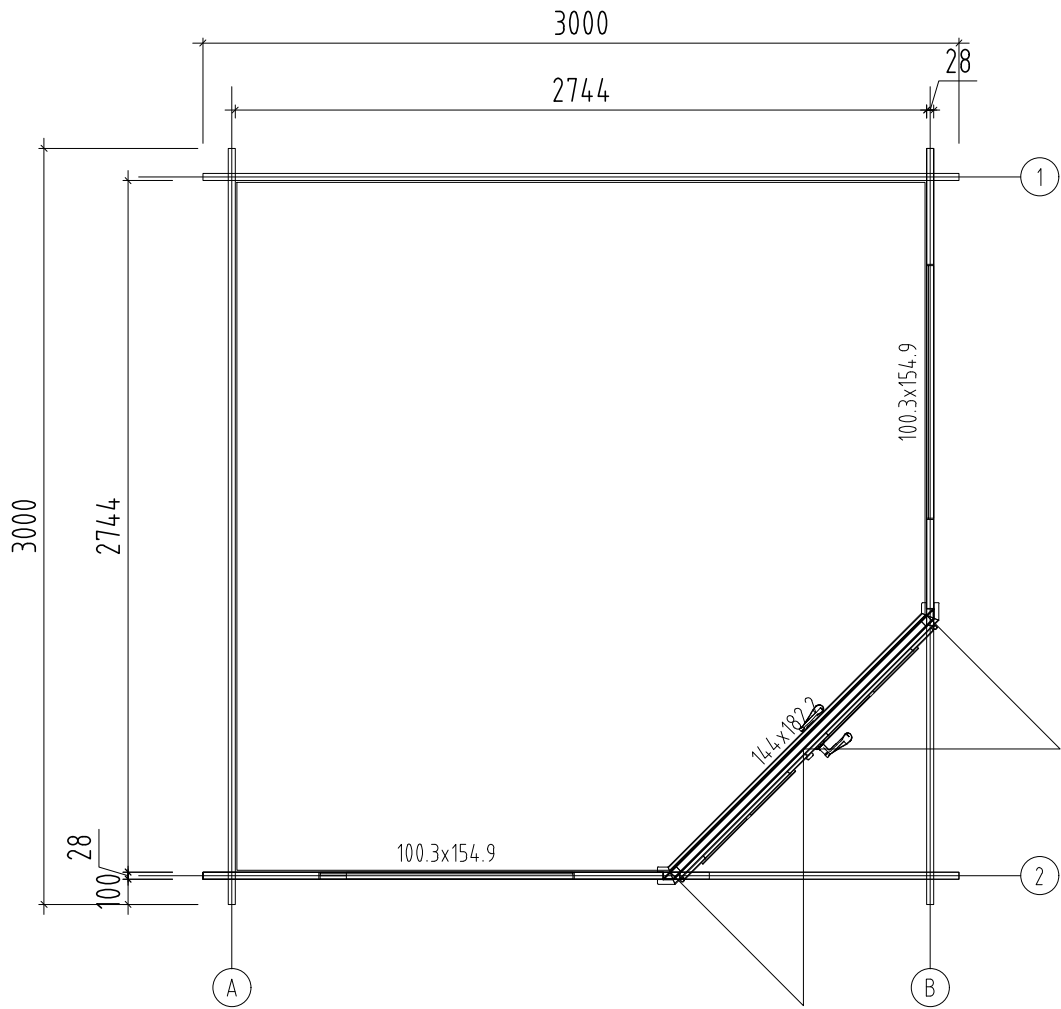

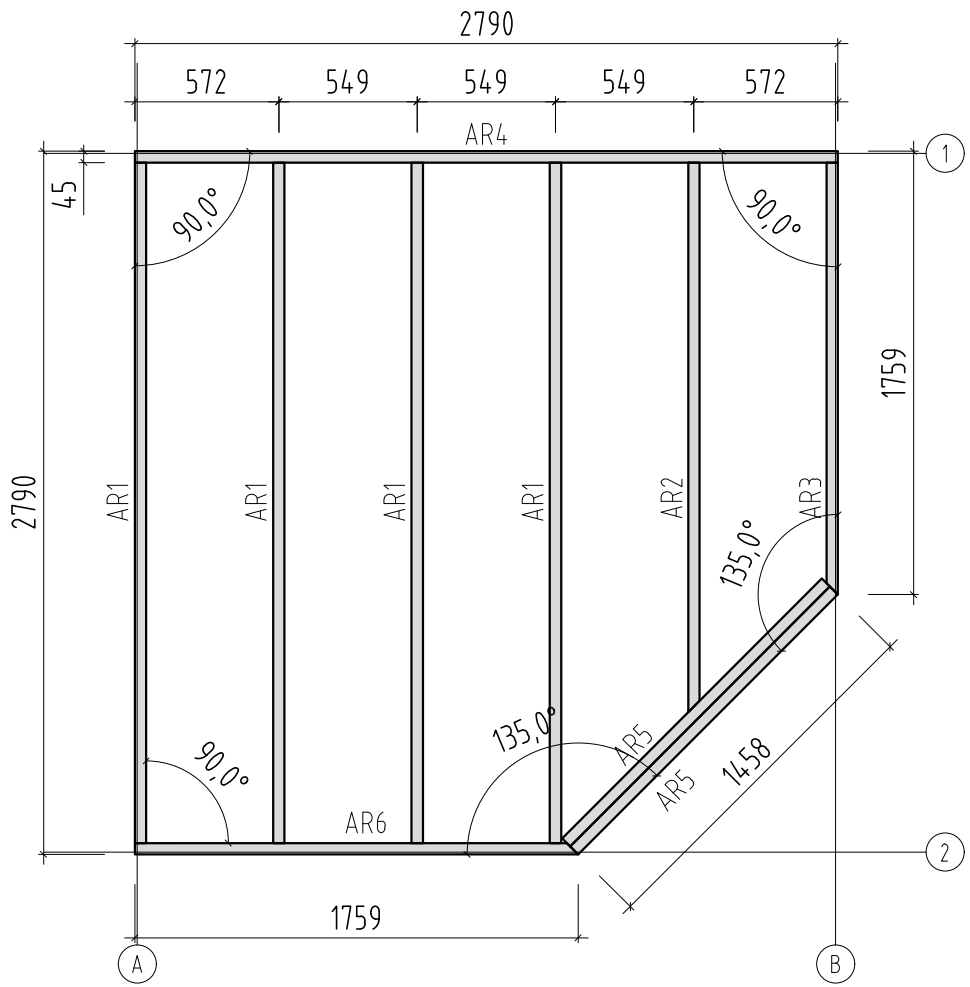

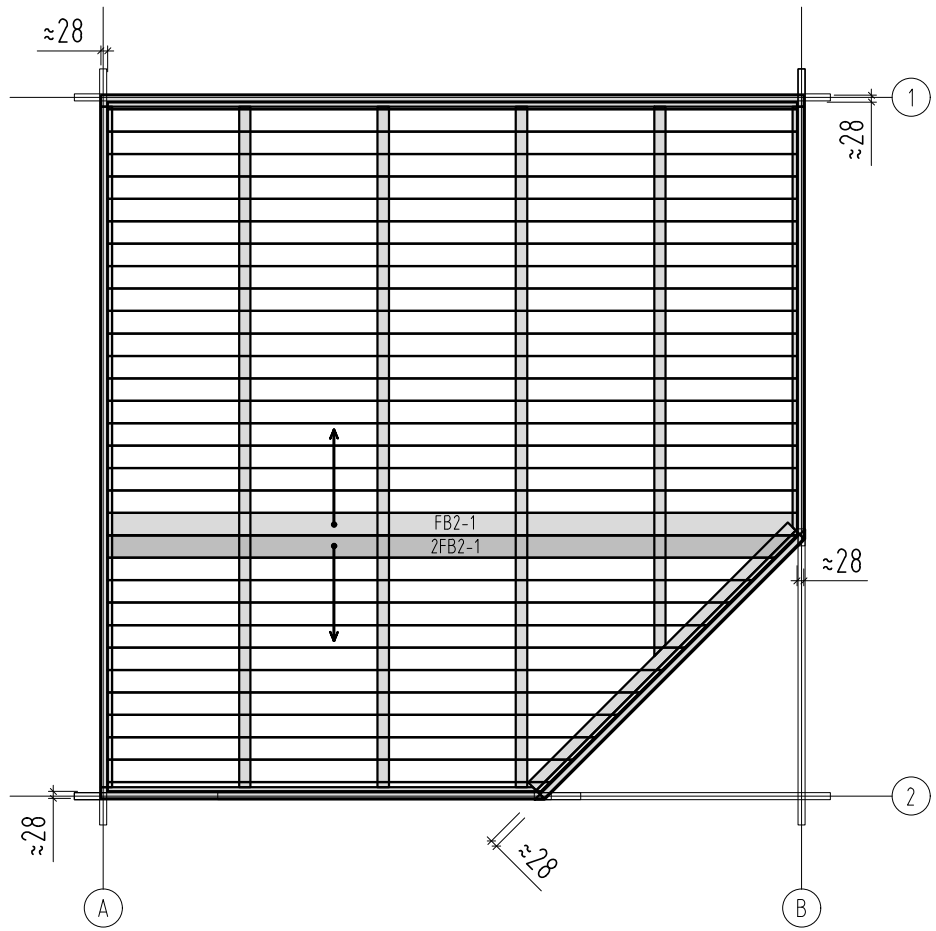

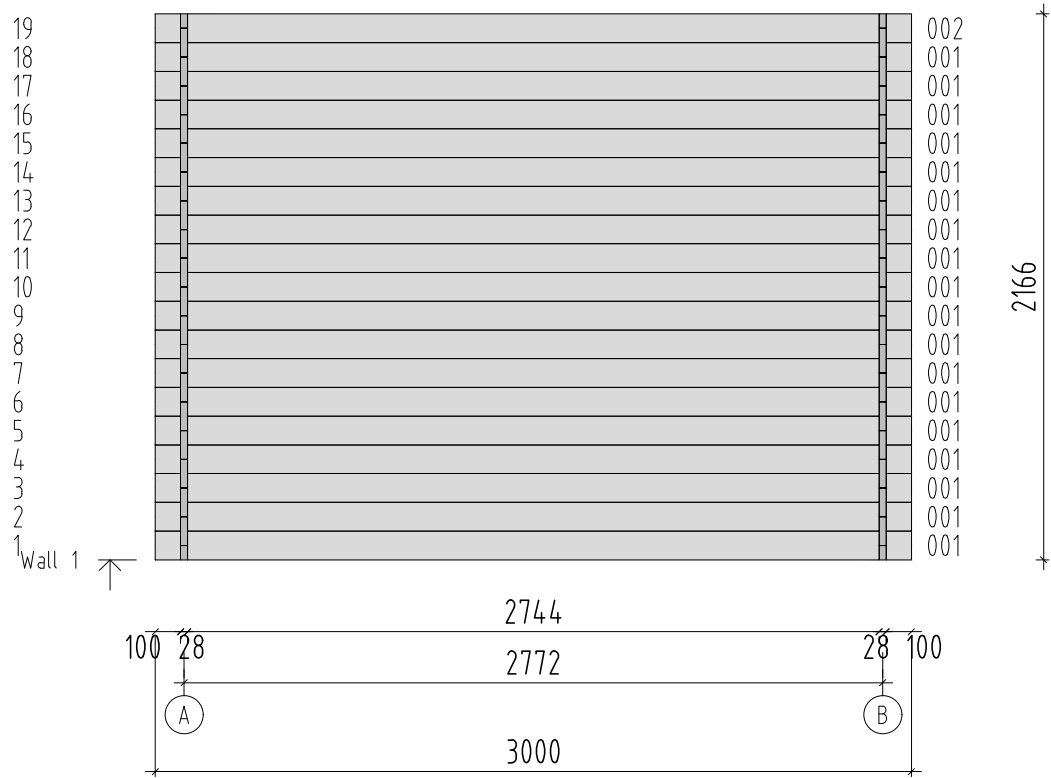

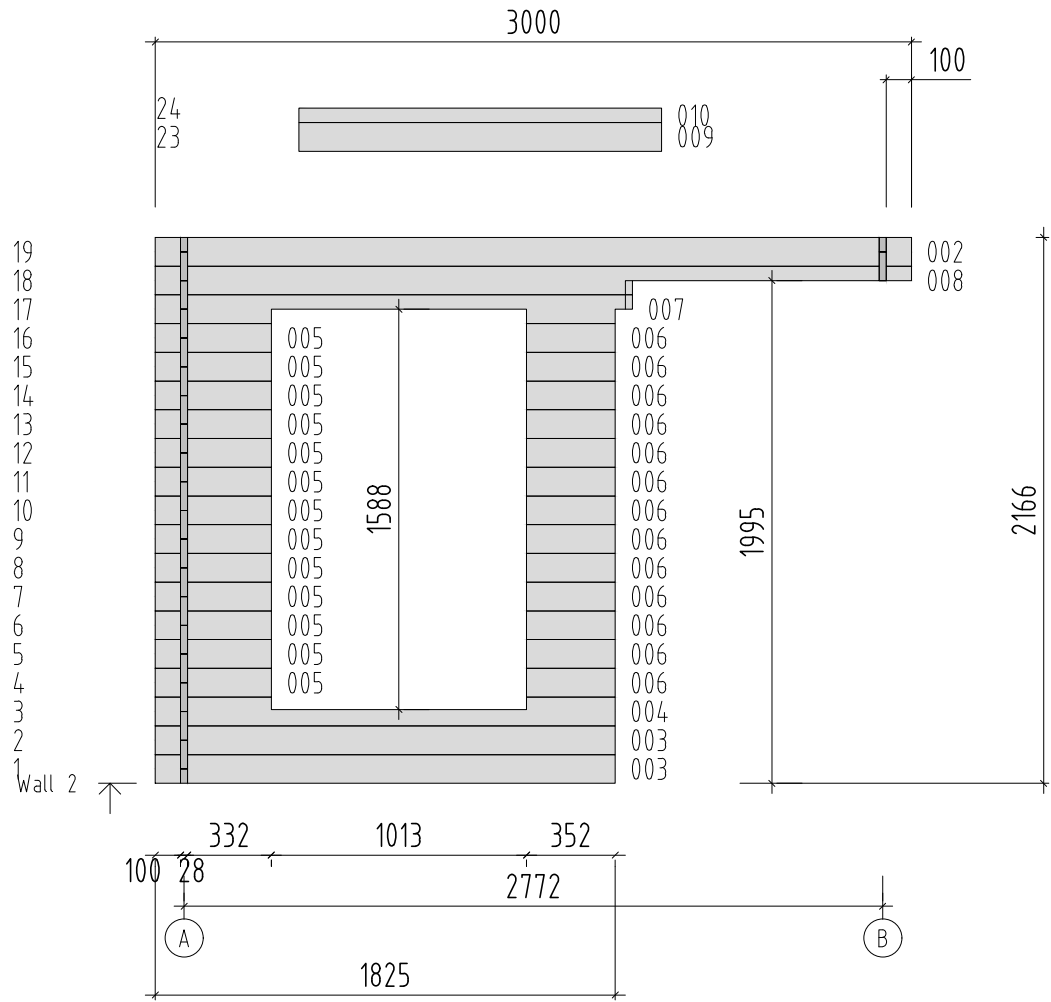

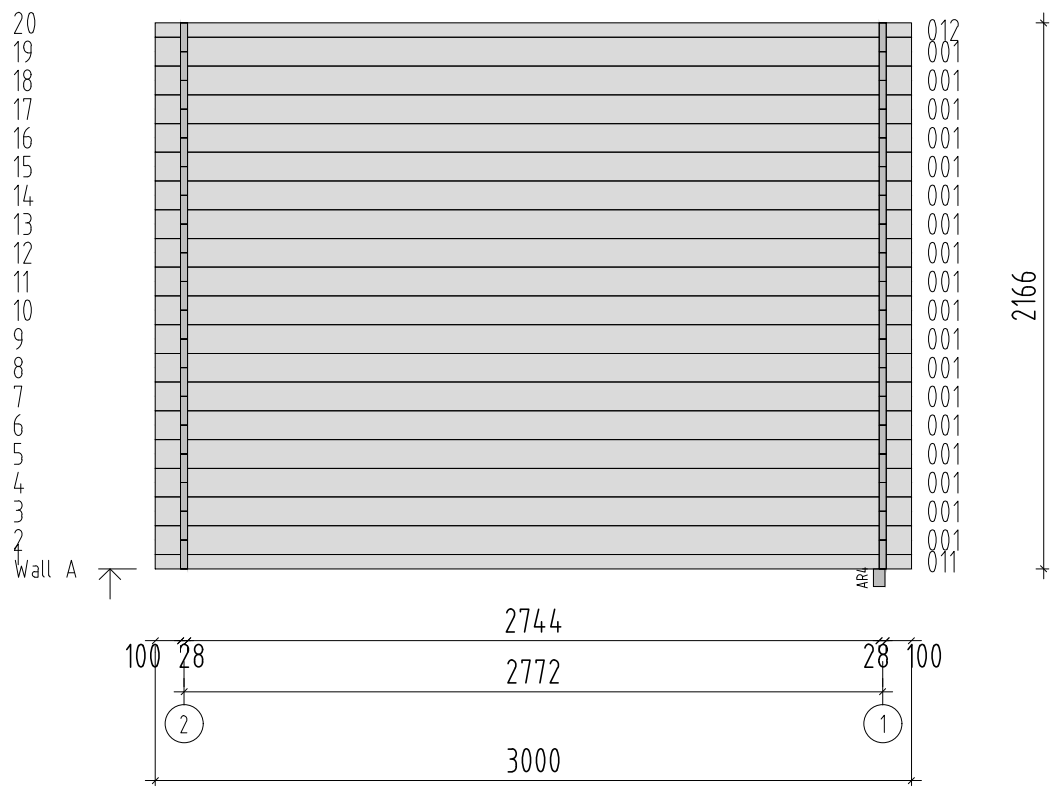

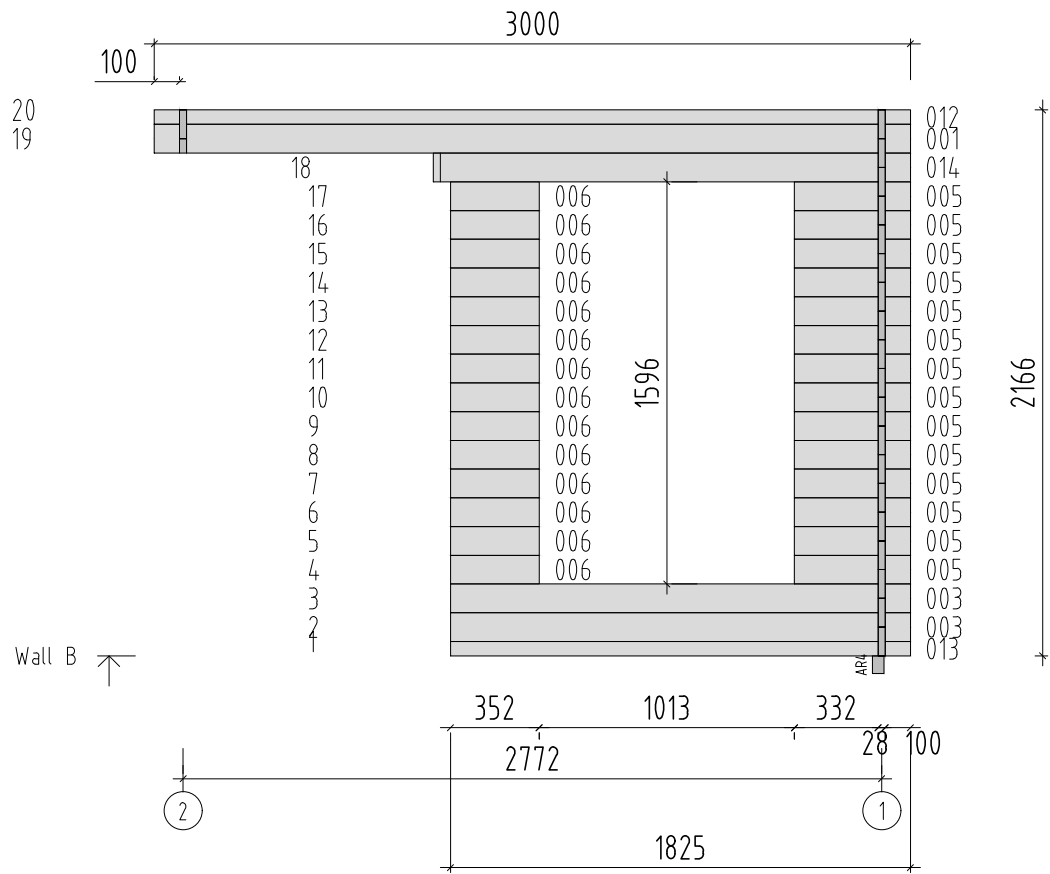



A:A

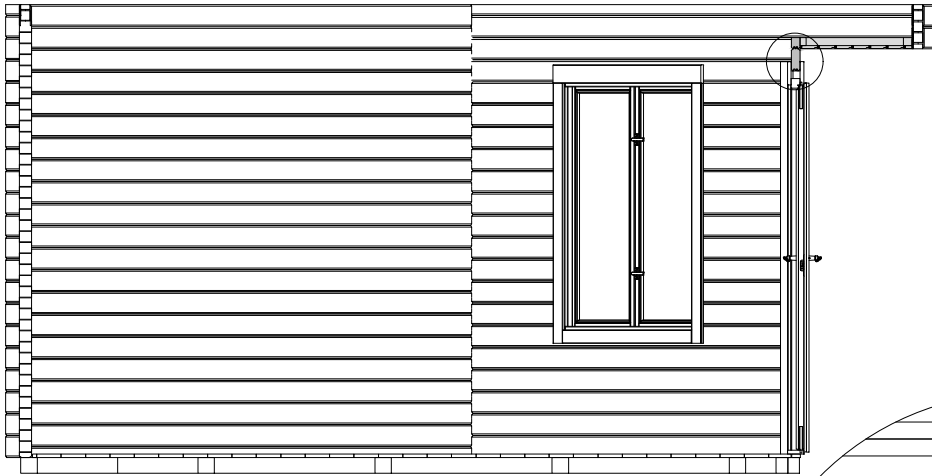

$\phi 3,5 \times 50 \times 3$

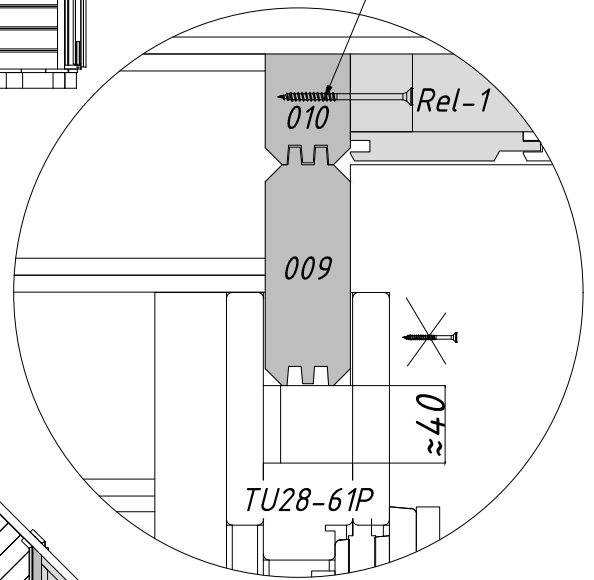

A

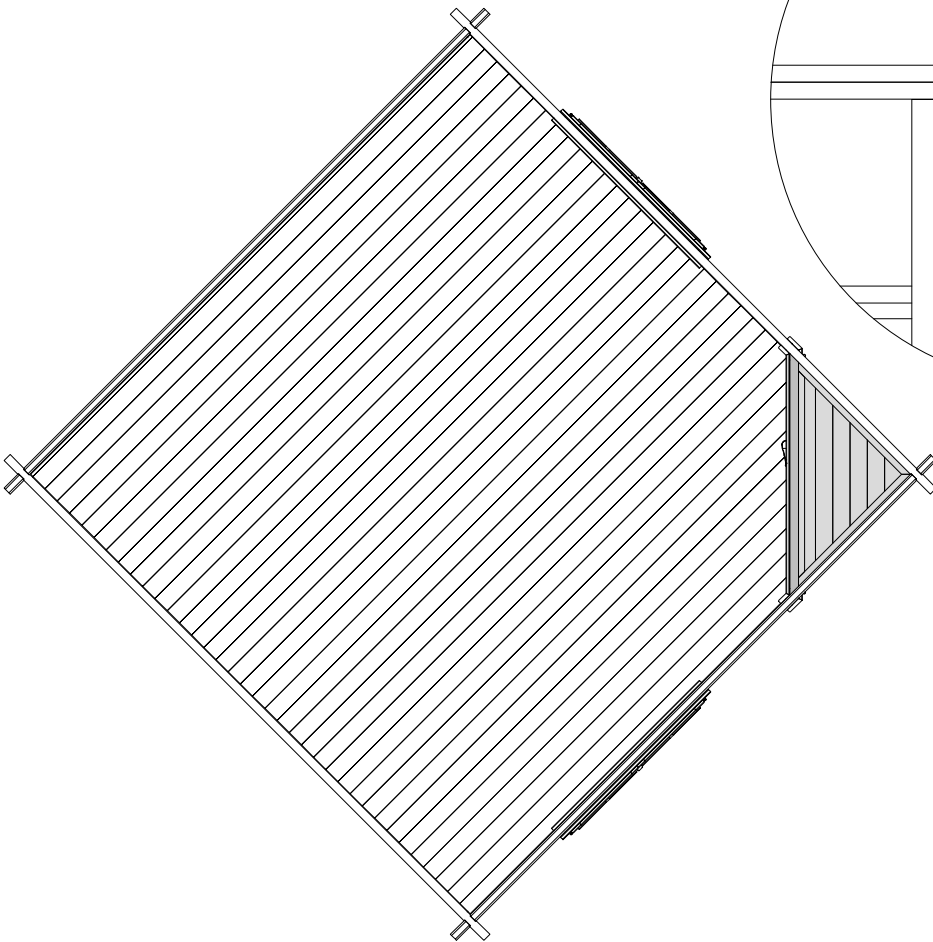

A

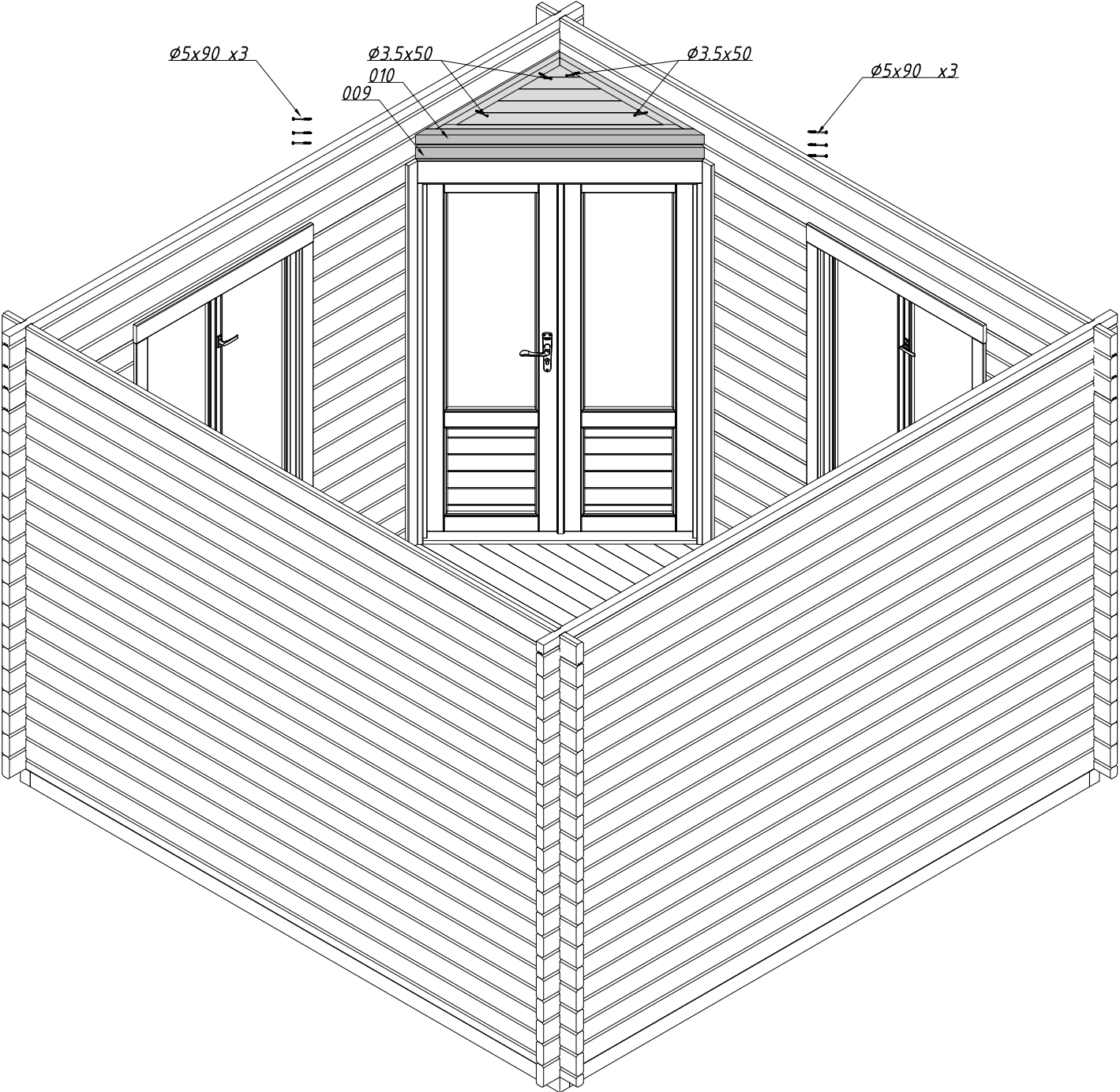

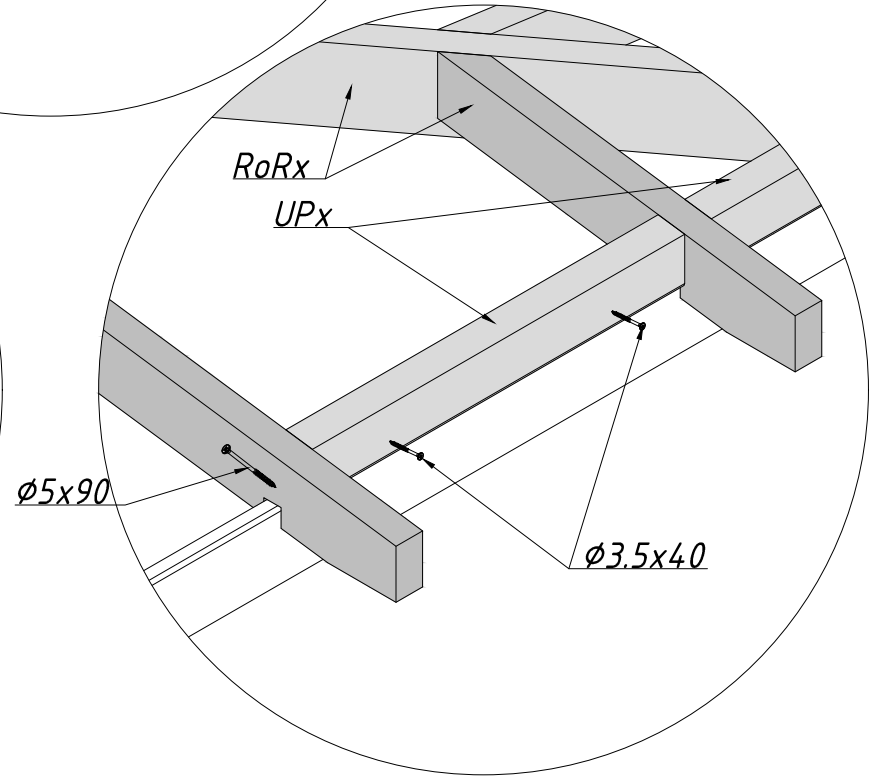
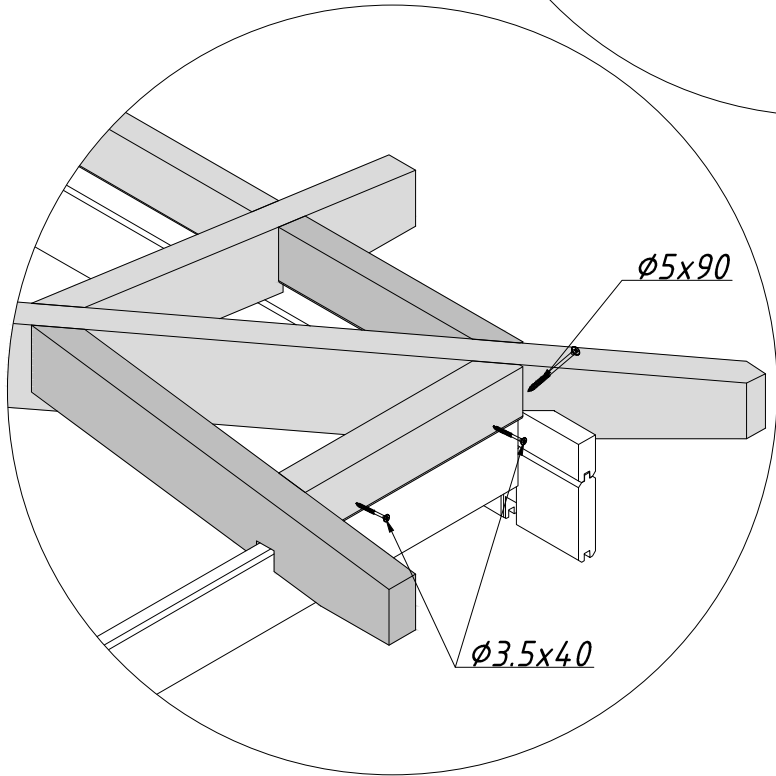
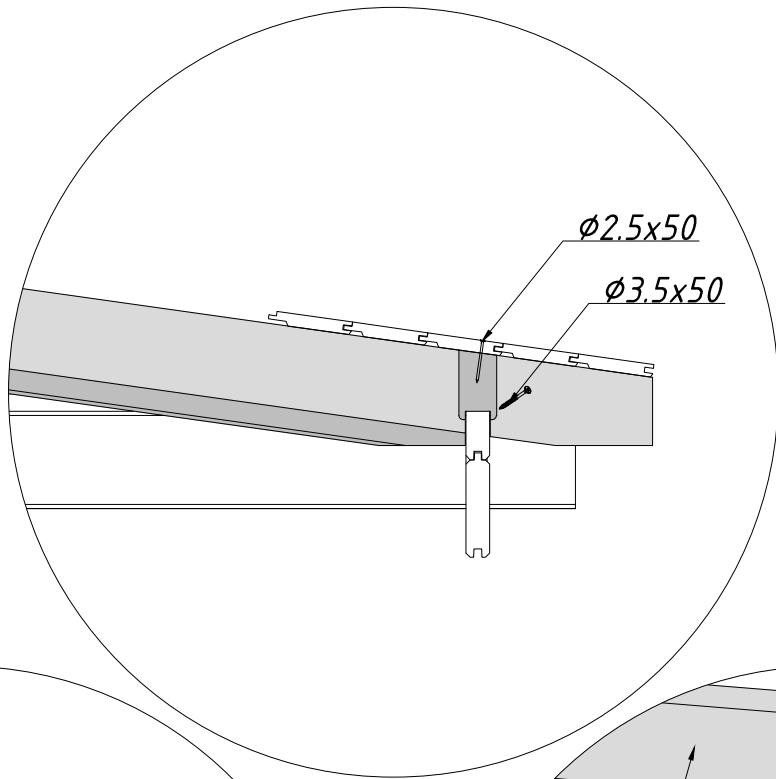

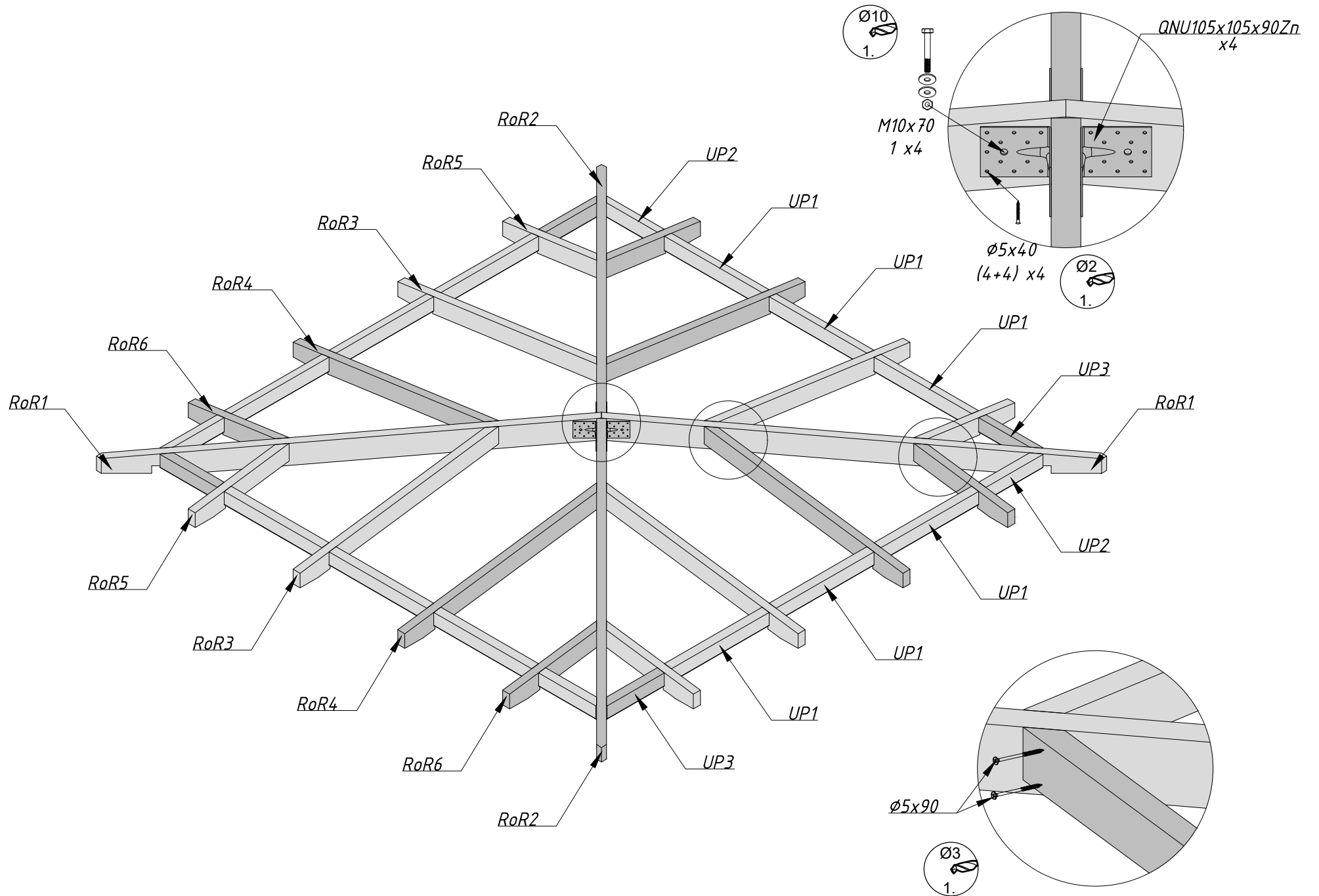

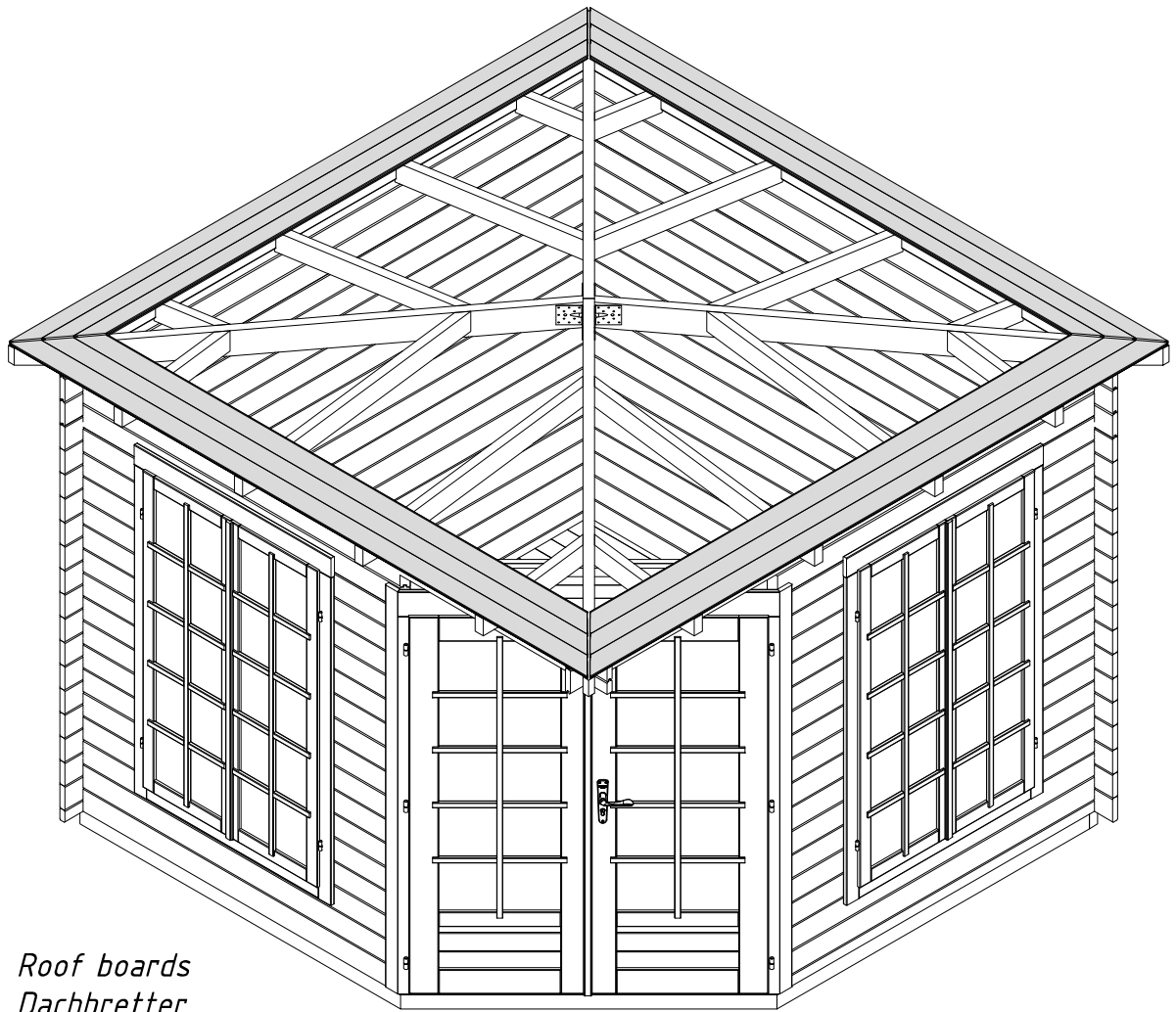

- EN *Roof boards*
- DE *Dachbretter*
- FR *Lames de toit*
- ES *Tablas de techo*
- IT *Tavole di tetto*
- NO *Takborder*
- SE *Takbrädor*
- FI *Kattolaudat*
- DK *Tagbrædder*
- NL *Dakbeschot*
- PT *Tábuas de telhado*
- CZ *Dřevěné desky na střechu*
- PL *Deski dachowe*
- LT *Stogo lentos*
- LV *Jumta dēļi*
- RU *Доски для крыши*
- ET *Katuselauad*

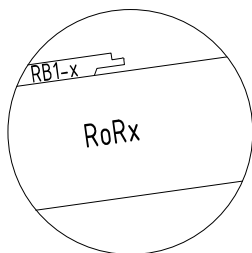
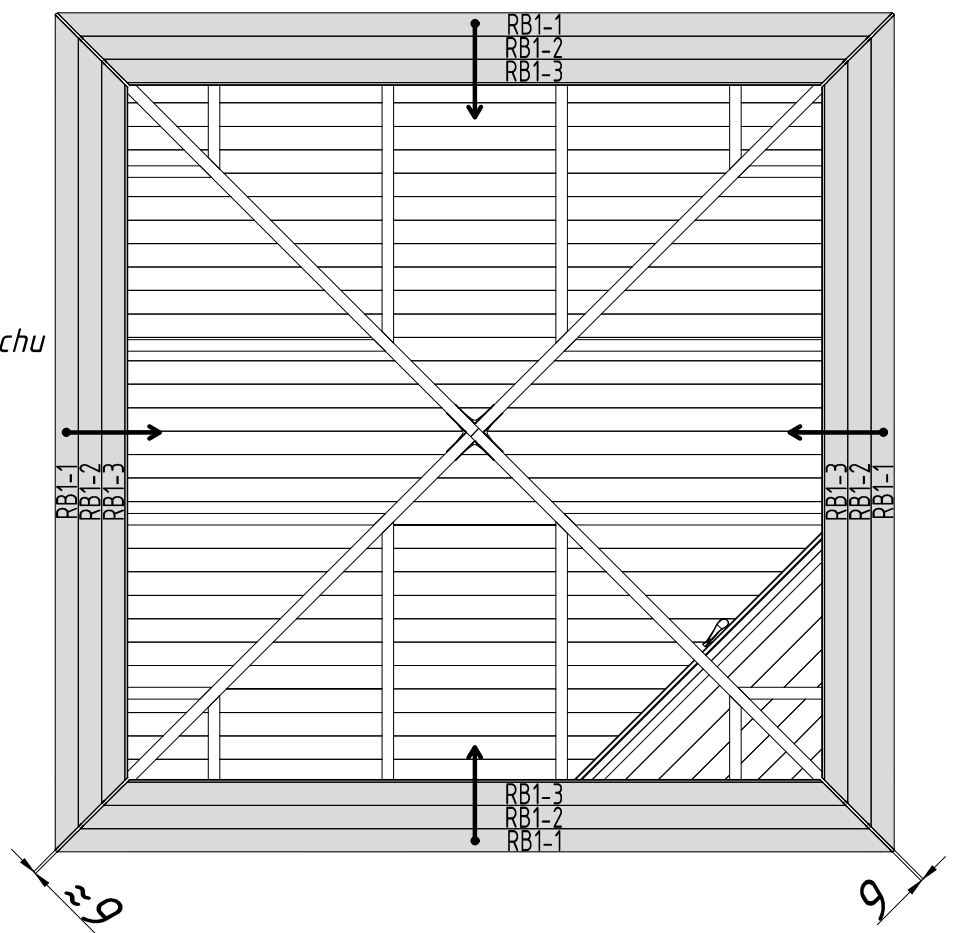

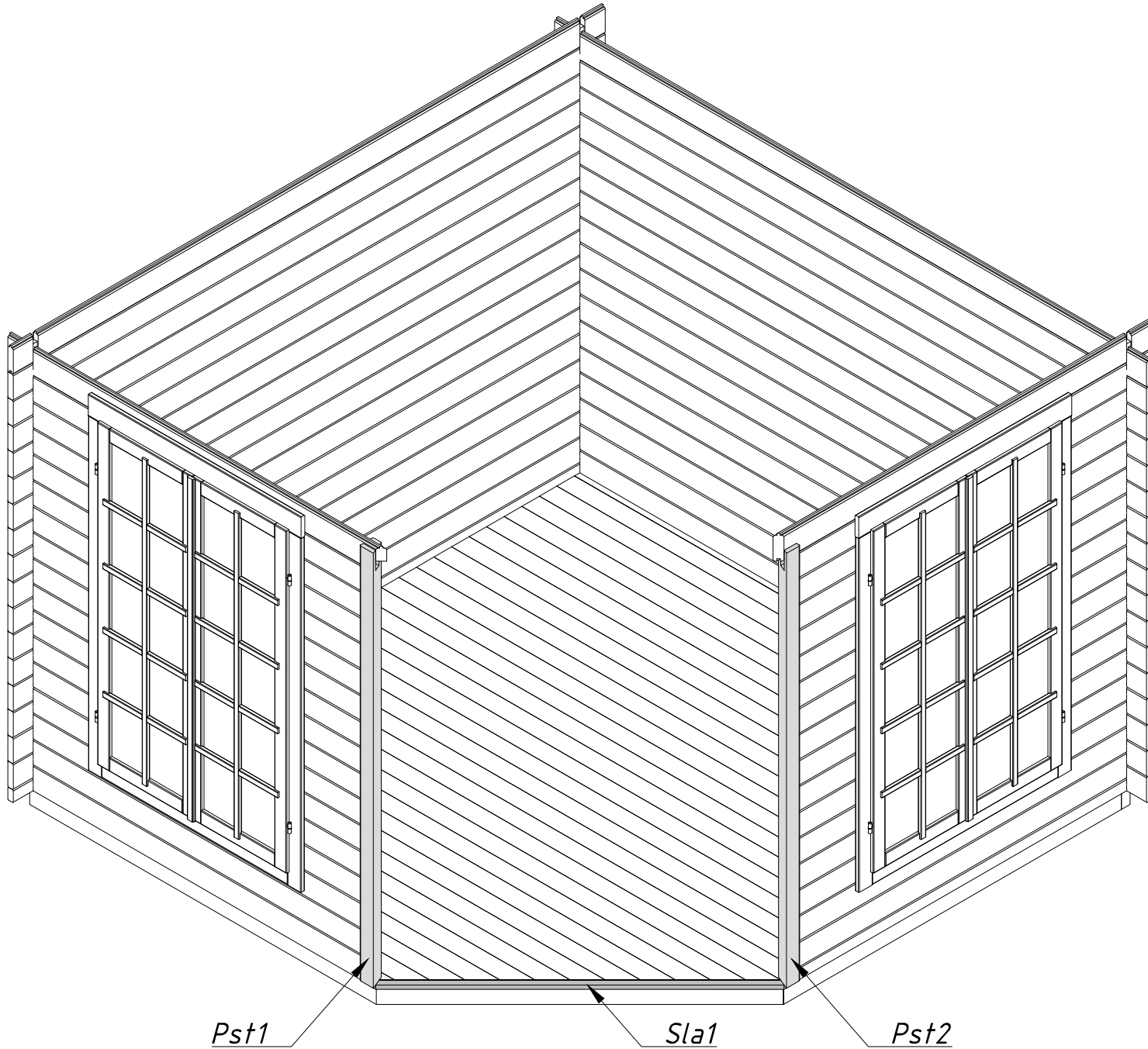

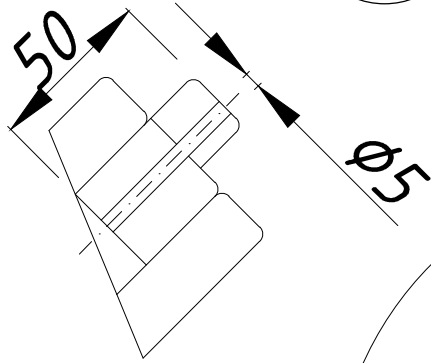
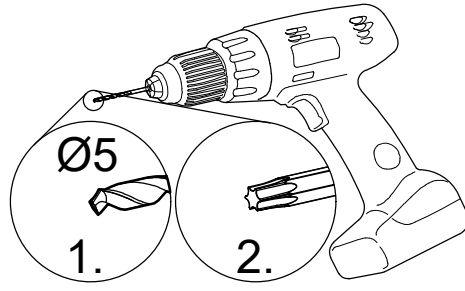

5x90  
4 pcs

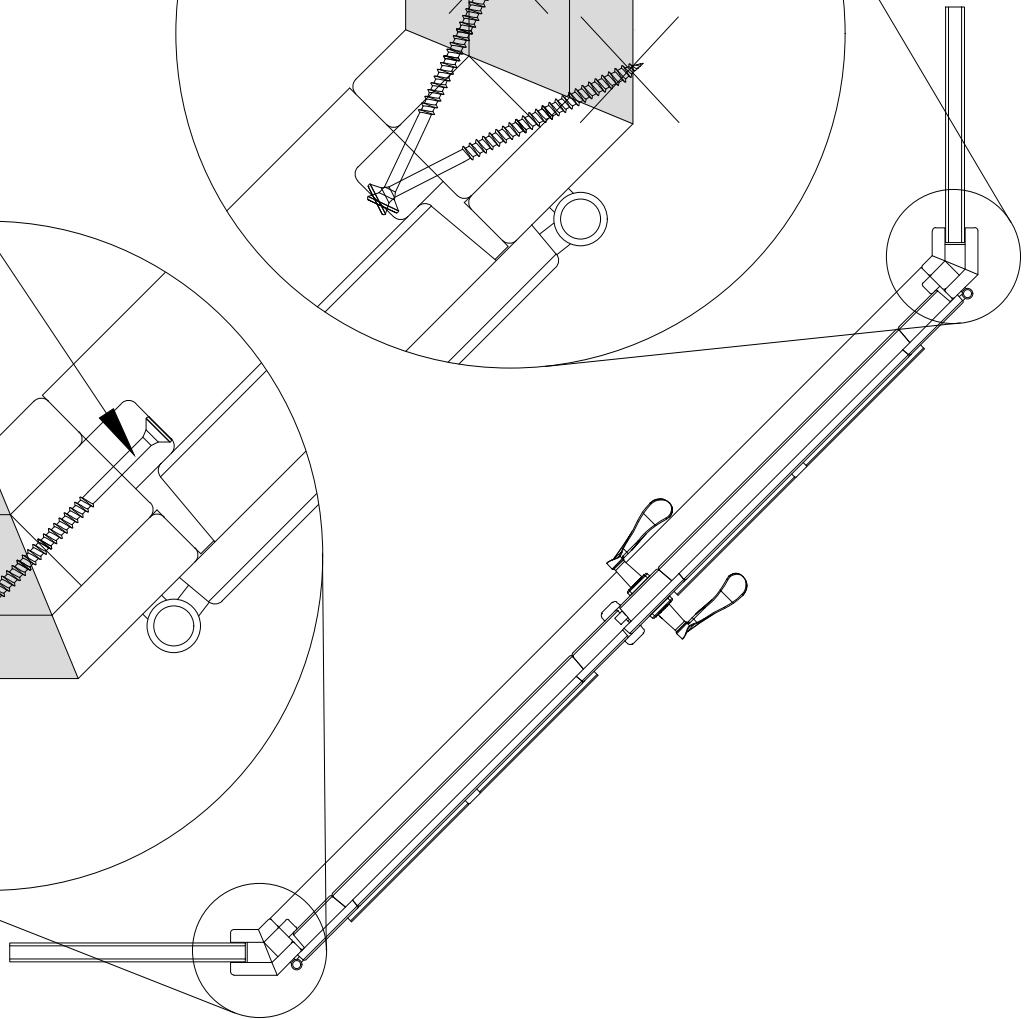
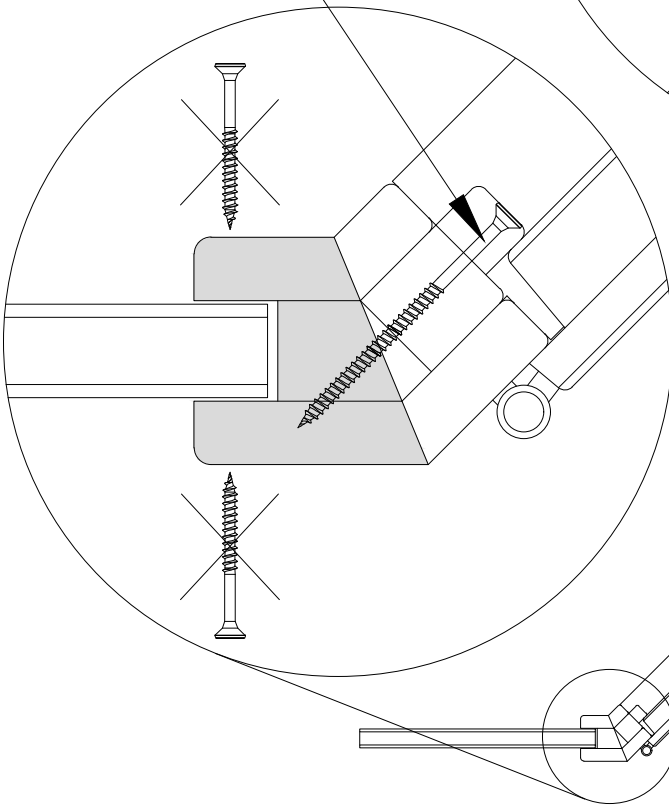
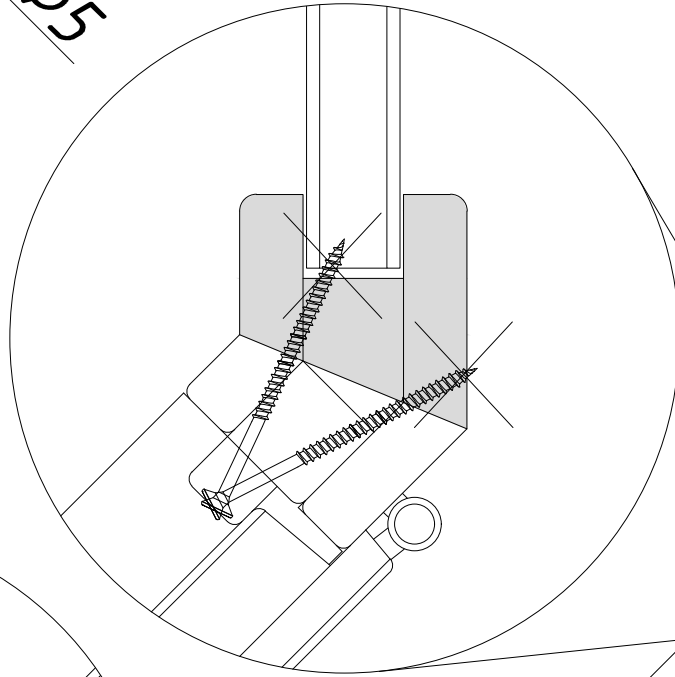

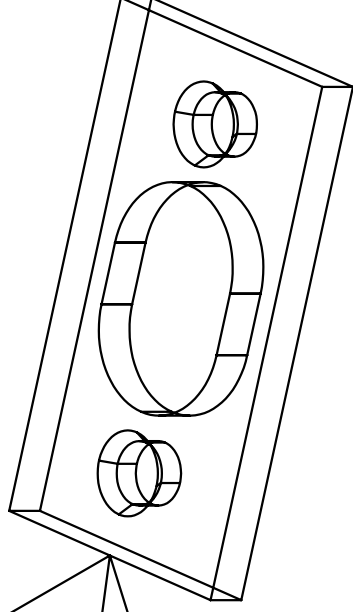
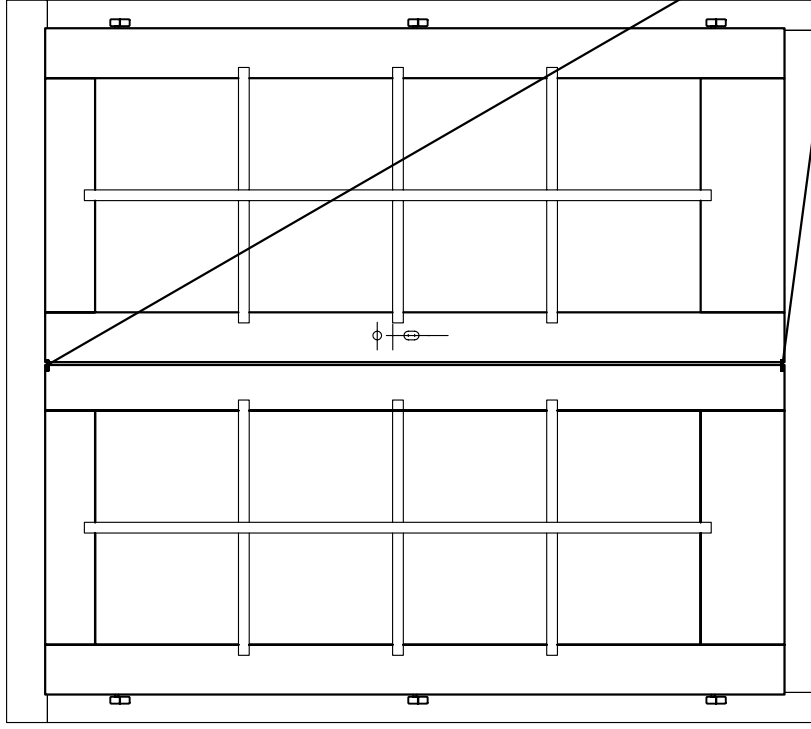

1. Drill a suitable hole.
  2. Fix the keepers with 2.5x16 mm screws.
  3. If the house has a metal door sill, the keeper is not needed.
1. Ein passendes Loch bohren.
  2. Das Schliessblech mit 2,5x16 mm Schrauben befestigen.
  3. Falls die Tür eine Edelstahlschwelle hat, brauchen sie kein Schliessblech.
1. Percer un trou approprié.
  2. Fixer la tôle avec des vis de 2,5x16 mm.
  3. Si la maison a un seuil de porte en inox, le tole n'est pas nécessaire.
1. Trapanare un buco adatto.
  2. Fisser la lamiera con 2,5x16 mm viti.
  3. Se la casa ha una porta in metallo davanzaile, il lamiera non è necessario.
1. Taladra un hueco apropiado.
  2. Fije las aldamas de candado con 2,5x16 mm tornillos.
  3. Cuando la casa tiene protector de pisada metálico, la aldaba de candado no es necesario.



## 1 General information



**Dear client,**

We are glad that you have decided in favour of our garden house!

**Please read the assembly manual carefully before proceeding with the house installation!** You will thus avoid problems and will not waste time.

### **Recommendations:**

- Keep the house package until its complete assembly in a dry place, but not in direct contact with the ground, protected from weather conditions (moisture, the sun, etc.). Do not keep the house package in a heated room!
- When selecting the garden house location, make sure that the house will not be subjected to extreme weather conditions (areas of strong snowfall or winds); otherwise you should attach the house (for instance, with anchors) to the subsoil.



### **Warranty**

Your house is made from high quality fir and delivered in the natural (unprocessed) form. If, despite our thorough inspection, you should have complaints, please submit the filled out control sheet and purchase invoice to the product seller.

**ATTENTION: Please be sure to keep the documentation accompanying the house package! The control sheet includes the control number of the house. We can only review complaints if you submit the control number of the house to the seller!**

The warranty does not cover:

- Peculiarities of wood as a natural material
- Wooden details already painted (processed with a wood preservative)
- Wooden details containing whole branches that do not endanger the stability of the house
- Colour tone variations caused by wood structure differences that do not influence wood lifetime
- Wooden details containing (caused by drying) small cracks/gaps that do not pass through and do not influence the structure of the house
- Twisted wooden details if they can nevertheless be installed
- Roof and floor boards that may have on their concealed surfaces some non-planed areas, colour differences and waning
- Complaints resulting from an incompetent manner of the installation of the house or the house subsiding due to an incompetently made foundation
- Complaints caused by introducing self-initiative changes to the house, such as the deformation of wooden details and doors/windows due to an incompetent manner of wood processing; the attachment of storm braces too rigidly, doorframes being screwed onto wall logs, etc.

**The complaints covered by the warranty are satisfied to the extent of replacing the deficient/faulty material. All other demands will be excluded!**



## Garden house painting and maintenance

Wood is a natural material, growing and adapting depending on weather conditions. Large and small cracks, colour tone differences and changes, as well as a changing structure of wood are not errors, but a result of wood growing and a peculiarity of wood as a natural material.

Unprocessed wood (except for foundation joists) becomes greyish after having been left untouched for a while, and can be turn blue and become mouldy. To protect the wooden details of your garden house, you must immediately process them with a wood preservative.

We recommend that you cover the floor boards in advance with a colourless wood impregnation agent, especially the bottom sides of the boards, to which you will no longer have access when the house is assembled. Only this will prevent moisture penetration.

We definitely recommend that you also process the doors and windows with a wood impregnation agent, and do that namely both inside and outside! Otherwise the doors and windows can become twisted.

After the house assembly is completed, we recommend for the conclusive finishing a weather protection paint that will protect wood from moisture and UV radiation.

When painting, use high quality tools and paints, follow the paint application manual and manufacturer's safety and usage instructions. Never paint a surface in strong sunlight or rainy weather. Consult a specialist regarding paints suitable for unprocessed softwood and follow the paint manufacturer's instructions.

Having been properly painted, your garden house's lifetime will increase substantially. We recommend that you inspect the house thoroughly once every six months.

## 2 Preparation for assembly

### Tools and preparation of components

To assemble the garden house, you will need the following tools:



assembly aid



ladder



hammer

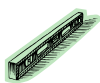

water-level



screwdriver



saw



knife



measuring tape



pliers



drill

**ADVICE:** To avoid splinters, we recommend that you wear the corresponding protective gloves during the assembly process.

# Installation manual

---

## Preparation of components:

Sort the components based on the wall plans (see Technical specifications) and place them at the four sides of the house in the installation sequence.

**ATTENTION:** Never place the components directly on grass or a muddy surface because it will be very difficult or even impossible to clean them up later!

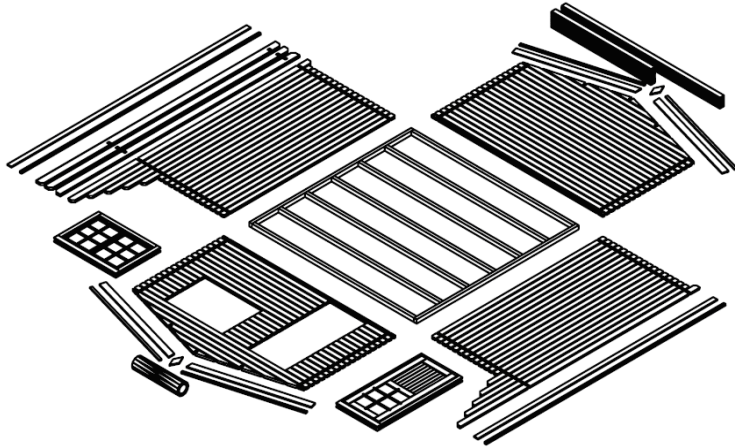

## **Foundation**

A good foundation is the most important aspect guaranteeing the duration and safety of your house. Only a completely level and bearing foundation will ensure problem-free installation of the house, its stability and especially the matching of the doors. With a good foundation, your house will stand for many years more.

Prepare the foundation so that its upper edge extends from the ground to a height of at least 5 cm. At the same time make sure that there are sufficient air apertures under the house floor for ventilation.

We recommend the following foundation options:

- Strip or spot foundation
- Foundation from concrete or pavement slabs
- Cast concrete bed

Prepare the foundation so that the foundation joists are propped up on every side with intervals not exceeding 50-60 cm.

Consult an expert in this field or have the foundation prepared by specialists.

## **3 Garden house assembly**

### **ATTENTION:**

- You will find included in the house package one spare log (longest wall log).
- You will find included in the house package one spare board (longest roof or floor board).
- The house package also includes 2-3 marked hitting blocks (wall profile approximately 20-30 cm long).

All of the details listed above ARE NOT mentioned in the specification list.

- The drawings have the details marked with three-digit position numbers. The exact positions of those details that have the third digit "x" can be found in the specification list.

# Installation manual

## Base frame (Foundation joists)

The base frame of the house must be completely flat and level to ensure that the installation proceeds without problems.

**ATTENTION: different house can have different foundation placements – see the appended base frame drawing (in Technical specifications)!**

Place the impregnated foundation joists on the prepared foundation in accordance with the drawing at equal intervals. Make sure that the joists are level and prior to screwing them together.

**ADVICE:** It is recommended to place between the foundation joists and foundation a damp-proof course that will protect the house from moisture and decay.

**ADVICE:** To ensure protection from wind and storm, it is recommended to attach the foundation joists to the foundation (for this, you can use for instance metal angles, anchors, etc.). The corresponding materials are not included in the supplied kit!

Installation of foundation joists:

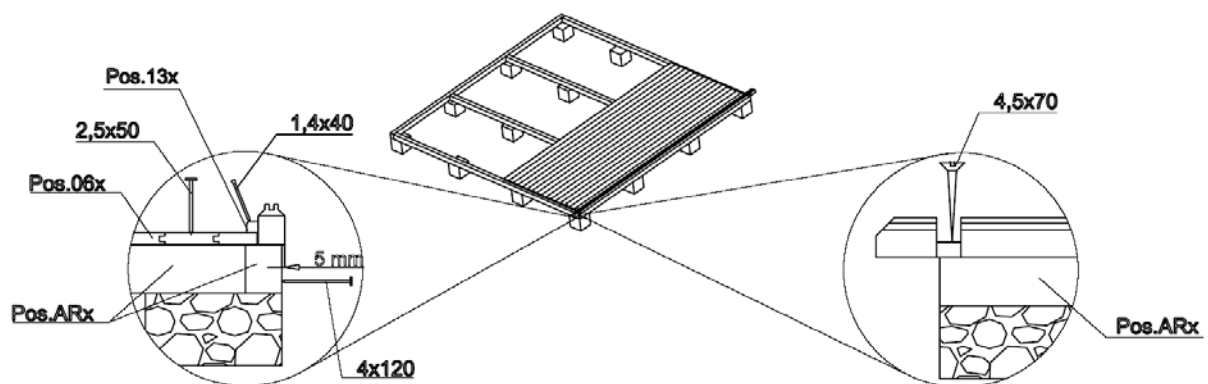

## Floor

Install the floor right after foundation bearers have been placed into position and screwed together. Cover the floor for the assembling time thus avoiding unnecessary smudging on the floor.

Start assembling the floor as shown on the drawing moving in both directions. If necessary, cut the last boards of the sides to suitable width.

When placing floor boards, please note that the boundary line of floor boards must be all around the floor 27 mm inside from external edge of foundation bearers. It will guarantee that the first layer of wall logs will fit on the base frame.

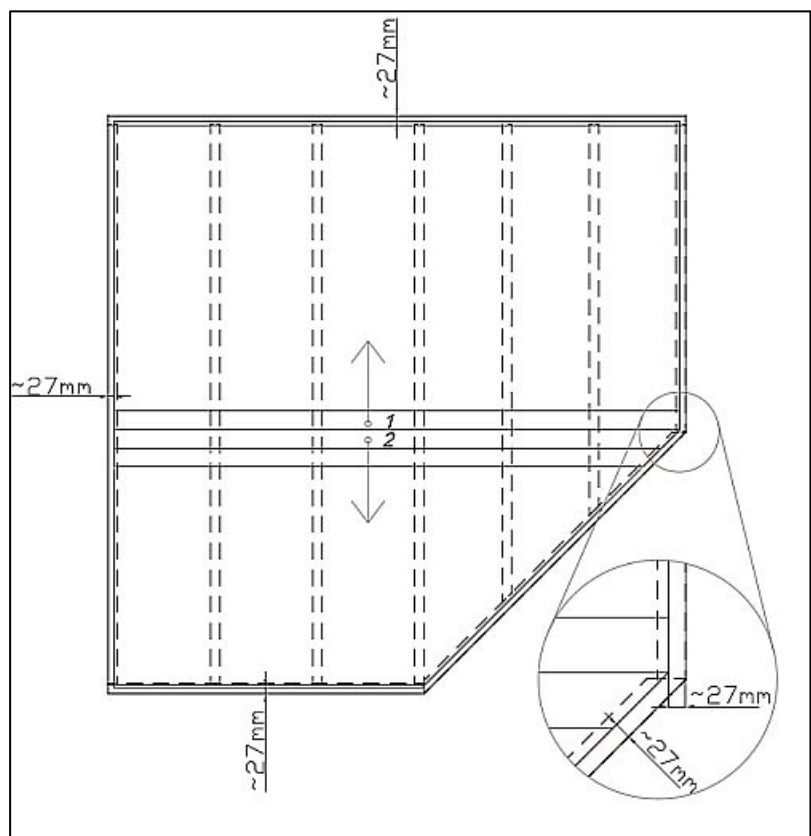

## Installation manual

---

Floor boards should be fixed to every foundation bearer with nails 2,5x50 mm. For nicer finish we suggest to nail the boards from top part of the tongue so the head of the nail will be covered with groove of next board.

The final operation is the fitting of the floor beadings to cover the spaces between the floor boards and walls. If necessary, cut the floor beadings to the suitable length.

**ATTENTION:** Depending on the climate at the house location, the floor boards can either swell or diminish. If the floor boards are very dry while the climate is damp, they will easily absorb moisture. In this case, the floor boards should not be attached very densely to avoid likely bulging. Leave some space (1-2 mm) between the floor boards to allow for swelling. But if your climate is warm and dry, you can install the boards densely because they will become drier and spaces may appear between them.

## Walls

When installing the walls, it is important to remember that:

- The logs are always assembled with their tongue upwards!
- If necessary, use the hitting block and hammer! Never directly hit the tongue with the hammer!

Install the walls in accordance with the appended wall plans (see Technical specifications).

First of all place half logs of front and back wall at the correct location and attach them with screws to the foundation joists. Then install the side wall logs. Make sure that the first layer of logs extends a bit over the foundation joists: the logs must extend over the joists by some 3-5 mm. You will thus protect the house from moisture, allowing the free flow of rainwater into the ground.

**ATTENTION:** After the first layer of logs, measure the diagonal lengths and, if necessary, re-install the logs. Only if the diagonal lengths are completely equal is the base frame rectangular and you can mutually attach the logs.

The first layer of logs:

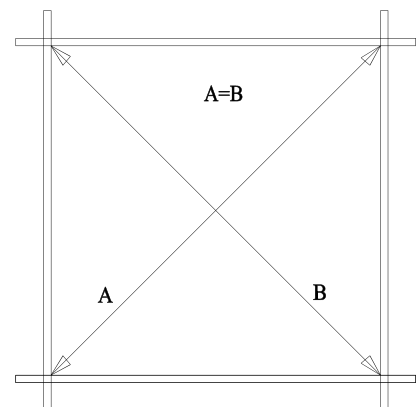

Continue the installation of the walls by strongly forcing the wall logs into one another. If necessary, use the hitting block and hammer. At the same time, do not forget to begin the installation of the door and windows. You should definitely begin the door installation after the 5<sup>th</sup>-6<sup>th</sup> layer of logs.

## Door and window

### Doorframe:

- If it is a double door, the doorframe is supplied in separate parts due to transportation requirements and you will have to begin by assembling it.
- To do this, place together the 4 parts of the frame and screw them onto one another.
- Make sure that the part of the frame with the deeper notch is installed upwards. The lateral jamb parts have hinges and are mirrored.
- It is recommended to install the leaves later.
- If it is a single door, its frame and leaf are supplied already assembled.

### Doorframe installation (Only necessary for a double door!):

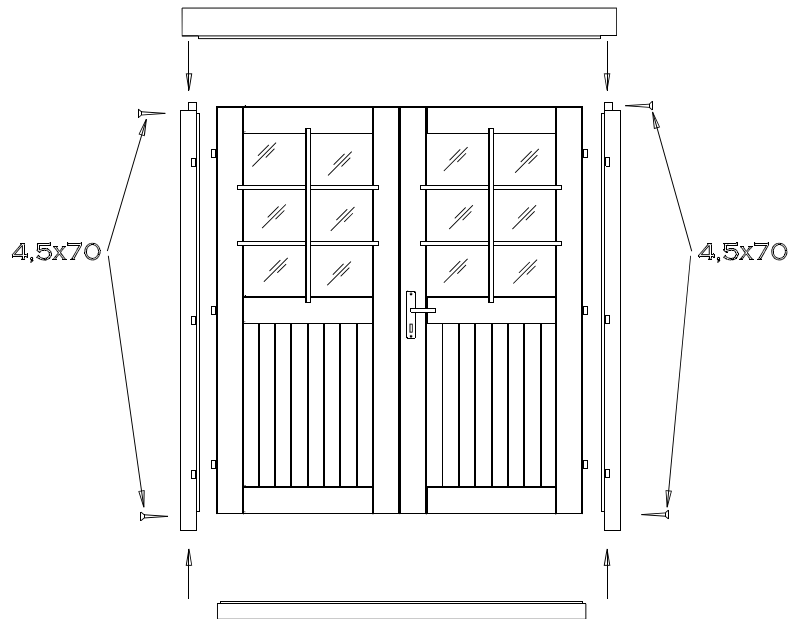

### Door installation:

The doorframe is placed at the formed aperture and pushed with force onto the lower log. If it is a double door, place the leaves on the hinges now. To open and close the door, fit the separately packaged lock and handle.

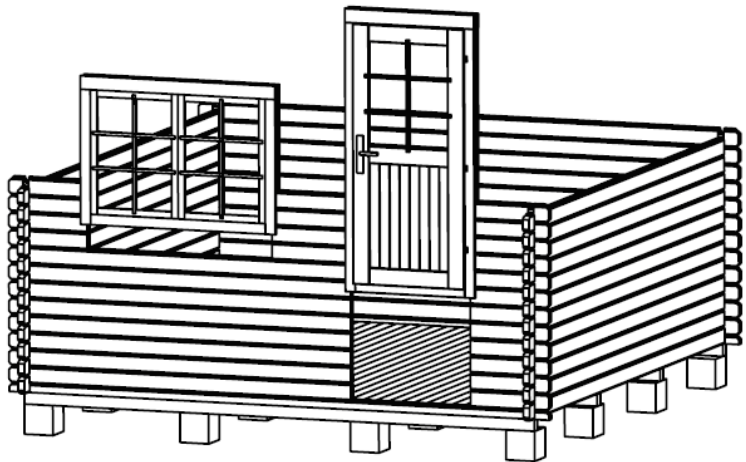

### Window installation:

Continue with the installation of the wall logs until you reach the window height. The wall plans (see Technical specifications) show how many logs go under the window. Install the window similarly with the door. Just like the door, push the window frame with the window into the window aperture onto the lower log, applying force. Make sure that the window is not fitted backwards (topsy-turvy).

**ADVICE:** Definitely make sure that the windows and doors open in the proper direction. The doors always open from the inside **to the outside**. The revolving-tilting windows open **to the inside**. The revolving and the slinging windows open **to the outside** (the window handles are on the inside).

**ATTENTION:** It is not necessary to fix the doors and windows to the wall logs! If you wish to do this, it will be sufficient to fix them with a couple of screws in the lower part of the frame because as they dry, the wall logs will begin subsiding.

You can conduct the final adjustments of the doors and windows only some 2-3 weeks after the house installation, when the house will have become adapted to weather conditions and its logs settled.

# Installation manual

---

## Roof

Before installing the roof, make sure that the house is completely level. Use the water-level to check all walls.

**ATTENTION:** When placing the roof, use a stable ladder. Do not step on the roof as the structure is suitable to sustain only an even load (snow, wind, etc.), and not a point load!

Install the purlins PR1 on the walls so that the notches will cover the corners of the walls. Fixate the purlins to the central fixing block (Pos. 153) and on the walls. Now place the pos. PR2 and PR3 from the top to the purlin and from the bottom to the upper wall log. Fixate the U-Profile boards between the purlins and on the walls.

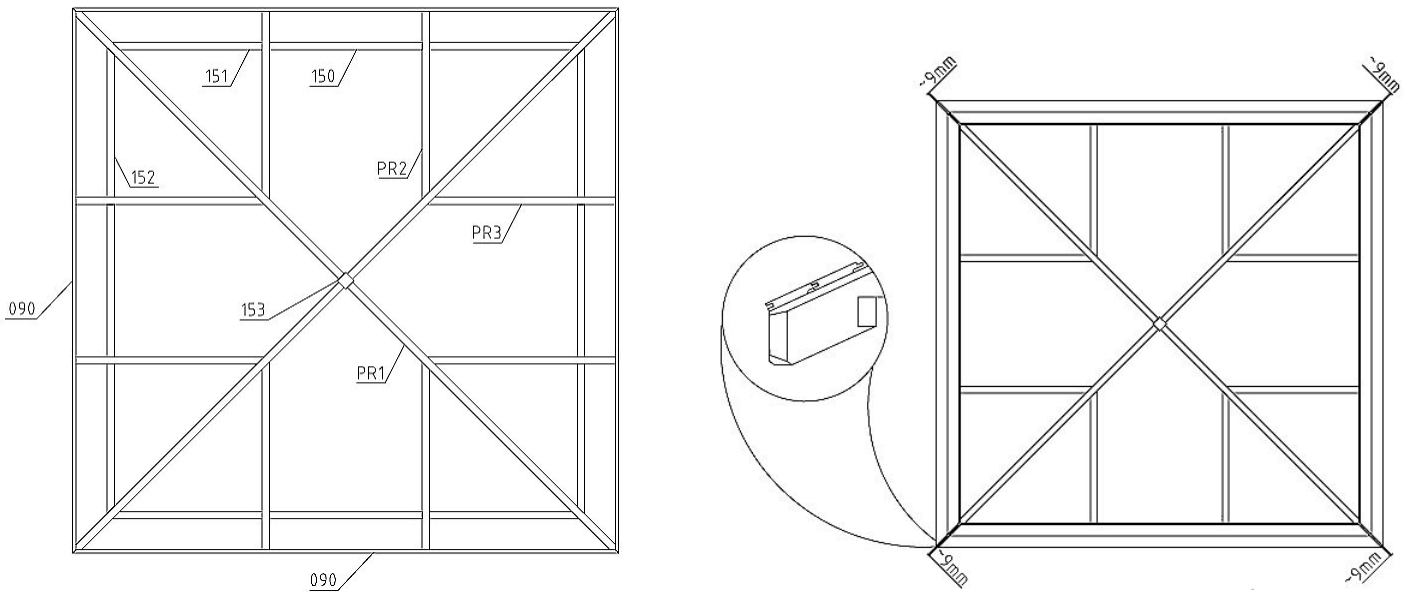

Start placing the roof boards with the longest board from the bottom. Put the groove side downwards that the bottom side of the board will meet the ends of the rafters. It is recommended to place the roof boards in turns on the all sides of the roof. 3-5 roof boards in one turn. Fixate the roof boards on the rafters with 2,5x50 mm nails.

After you have installed the roof boards, cover it with roof covering material (not included in house kit). It is necessary to avoid the bulging of the roof boards due to wetness.

# Installation manual

---

## Storm braces (NB! Not included in some house option kits!)

Attach the storm braces (if included in the supplied kit) to the inner sides of the front (2 units) and back (2 units) walls with the supplied bolts. It is important for the logs to be drilled through in advance. Please keep the distances indicated in the drawing so that no problems occur due to wood swelling or diminishing.

**ADVICE:** Make sure that the storm braces are attached to the apex log from above and to the middle of the first full-length wall log from below. If necessary, shorten the upper ends of the slats.

Do not turn the screws tightly so wood can further swell or diminish.

With the house having settled, you should adjust the attachments so the wall logs can settle.

### Installation of storm braces:

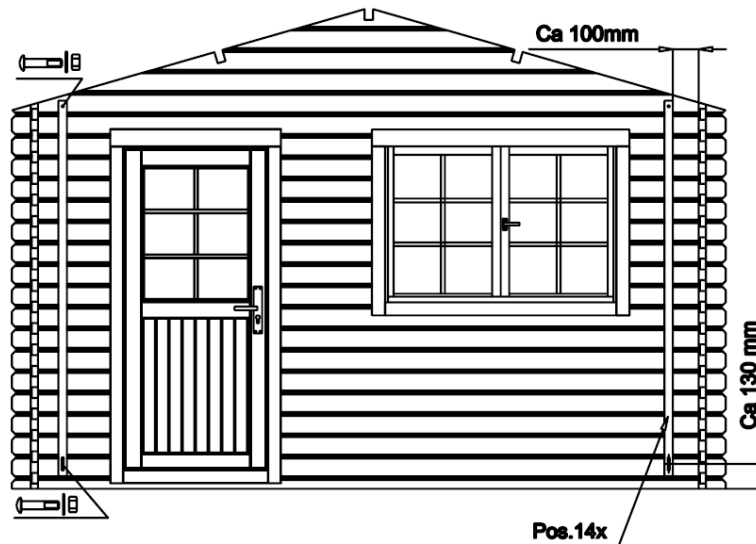

## General advice:

### **Problem:** *Gaps appear between the wall logs*

**Cause:** Additional details are attached to the house that do not allow wood to swell/diminish.

**Solutions:** If the door/window is attached to the wall logs with screws/nails, remove these screws/nails;  
If the storm brace is screwed on too tightly, loosen its attachment;  
If (rain water) pipes are installed on the wall, loosen their attachments;

### **Problem:** *The doors and windows become stuck.*

**Cause:** The house/foundation has settled.

**Solution:** Check whether the house is level. Level the foundation joists and walls.

**Cause:** The doors and windows have swelled due to moisture.

**Solution:** Adjust the door and window hinges; if necessary, plane the door or window narrower.



We wish you total success with the garden house installation and much joy with this house for many years to come!