

REVELATIOIII

L = 844 cm

W = 586 cm

H = 340 cm

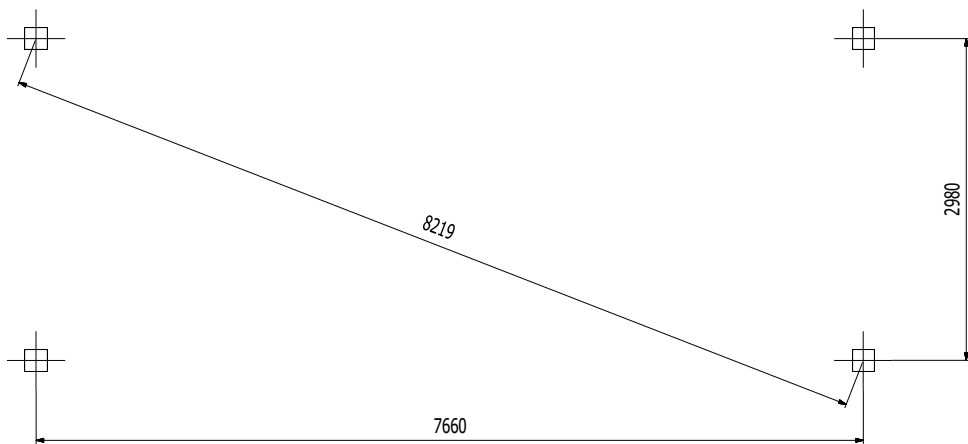
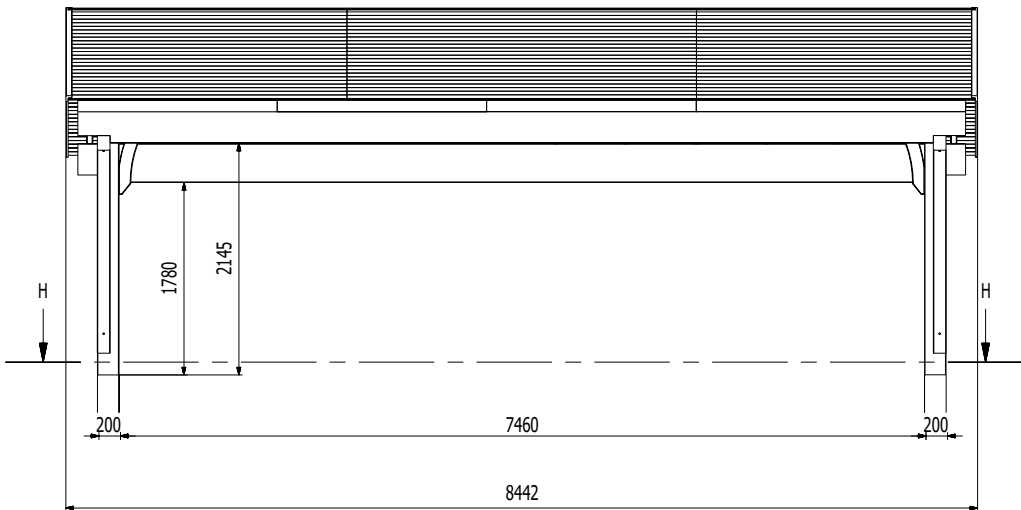

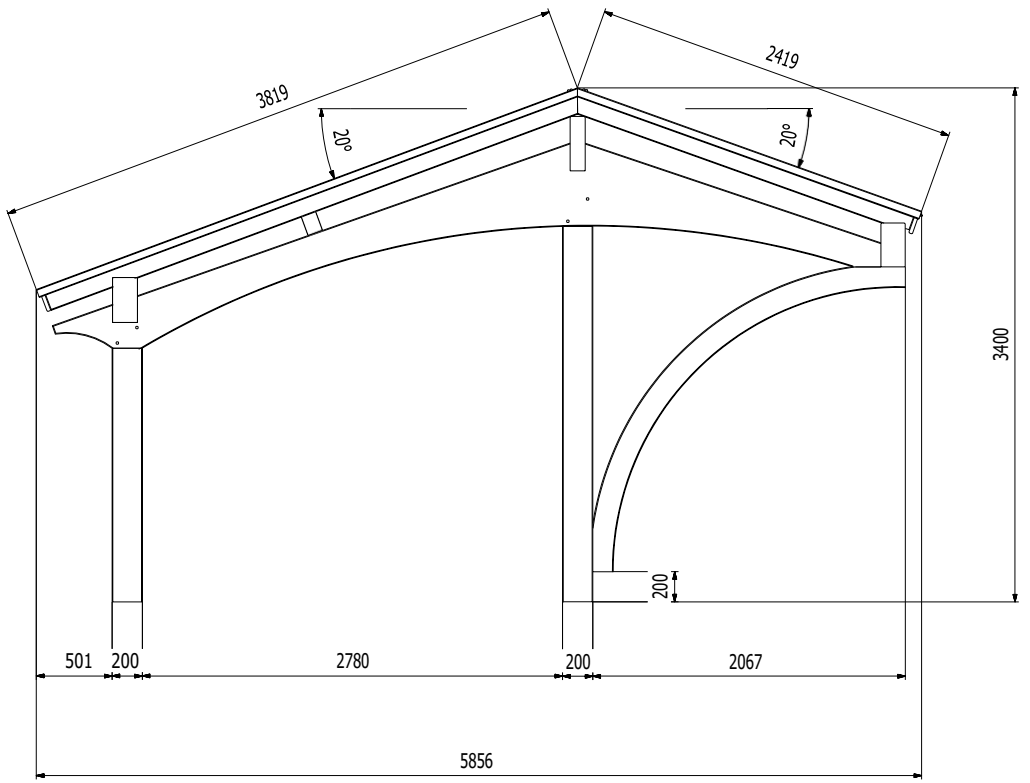

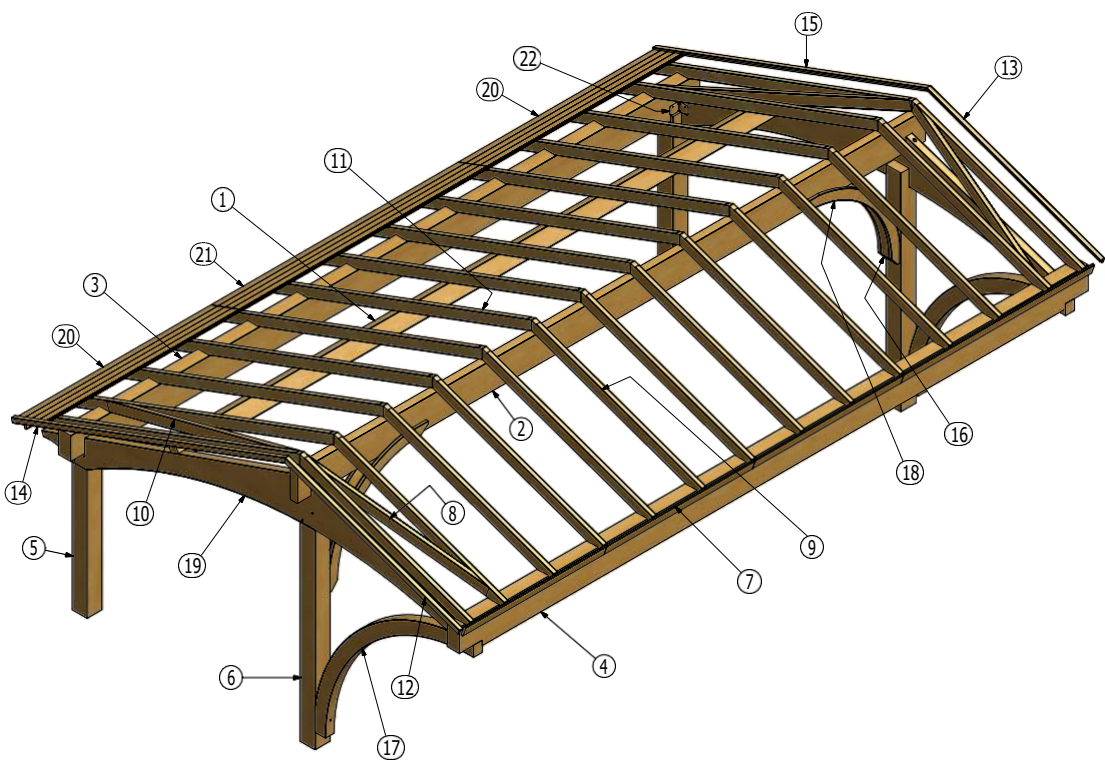

PARTS			PARTS		
PART	QNTY	PARTS	PART	QNTY	PARTS
1	1	beam 100x200x7860	12	1	beam 56x56x2419a*
2	1	beam 100x360x8220	13	1	beam 56x56x2419b*
3	1	beam 160x360x8220a	14	1	beam 56x56x3819a*
4	1	beam 160x360x8220b	15	1	beam 56x56x3819b*
5	2	post 200x200x1850	16	2	arch 100x120x1583Rw1090
6	2	post 200x200x2700	17	2	arch 118x160x2887Rw1880
7	2	beam 25x120x8220	18	4	arch 38x120x1838Rw1090
8	2	beam 56x120x2150	19	2	arch 88x560x5481Rw5800
9	14	beam 56x120x2370	20	128/160	beam 22x114x2582 / kantówka 22x94x2582
10	2	beam 56x120x3150	21	64/80	beam 22x114x3236 / kantówka 22x94x3236
11	14	beam 56x120x3763	22	8	Masking plate
				61,6 m ²	Felt tiles

* parts if bought including felt tiles

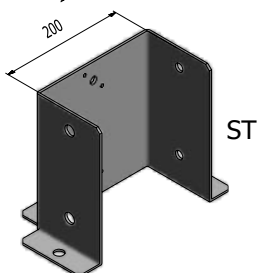
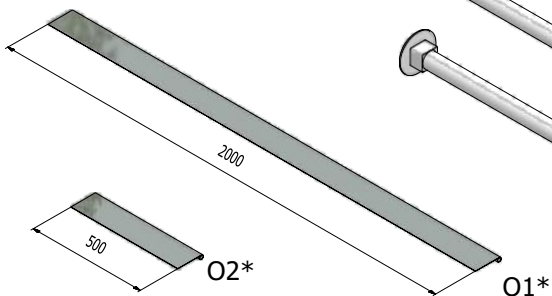
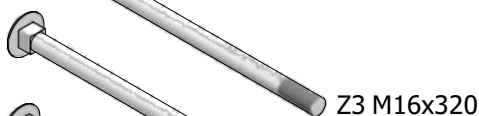
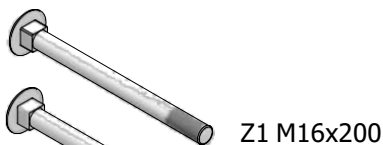
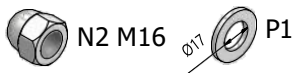
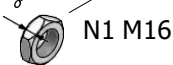
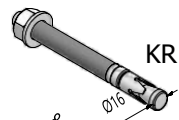
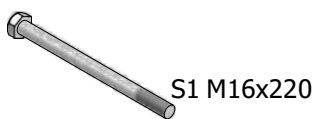
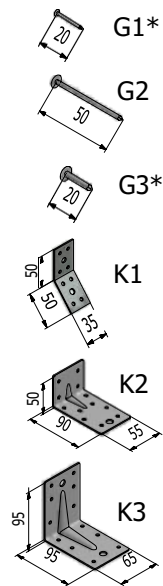

OKUCIA	
ELEMENT	ILOŚĆ
G1	36
G2	930/1160
G3	2900
K1	14
K2	4
K3	4
KR	12
N1	18
N2	26
O1	8
O2	2
P1	26
S1	8
ST	4
SW	2
W1	64
W2	100
W3	88
W4	64
Z1	4
Z2	8
Z3	2
Z4	2
Z5	2
Z1	64/80

* pozycje dostępne, przy zakupie konstrukcji z gontem

